

# Makita®



# 2024/25

ACCESSORIES CATALOGUE

# Safety



Wear Eye Protection



Wear Ear Protection



Wear A Mask



Wear Protective Gloves



Wear Protective Shoes



Read The Instruction Manuals



Remove Plug From Socket

# Materials

## Masonry



Reinforced concrete



Concrete



Aerated concrete



Concrete block



Brick



Plaster mortar



Soft brick



Stone



Limestone



Marble



Granite

## Wood



Wood



Wood with nails



Laminate board



Plywood



Chipboard



MDF

## Metal



Metal



Sheet metal



Metal stud



Non-ferrous metals



Aluminum



Stainless steel



Cast iron

## Other Materials



Glass fibre reinforced plastic, epoxy



Glass



Plastic



Ceramic tiles



Soft Tile



Fiber cement board



Removing paint



Removing paint from metal or polishing.



Plaster board



Epoxy



Asphalt



Insulation



Carpet



Silicon

Drilling (Wood/Metal)

20



Drilling (Masonry)

41



Fastening

58



Drill and Screw Bit Sets

67



Cutting

70



Jigsaw / Reciprosawing

83



Brushing

94



Bonded Abrasive

96



Coated Abrasive

105



Multi Tool

115



Diamond

125



Planing / Routing

138



OPE

144



Cleaning / Vacuum System

164



Miscellaneous

180



Blue Collection

225



# System Charts

## Screwing/Drilling

Drill  
Angle Drill  
Driver Drill



### Fastening P.58

Screw bit  
Socket bit



### Drilling (Wood/Metal) P.20

Drill bit



Step drill bit & Countersink bit



Hole saw



Hammer  
Driver Drill  
Hammer Drill



### Brushing P.95

Nylon brush & Wire brush



### Drilling (Masonry) P.42

Masonry bit with straight shank  
(Tungsten carbide-tipped bit)



Diamond Core  
Hammer Drill

### Diamond P.139

Diamond core bit  
(Dry type) (For Model 8406, 8406C)



Drywall  
Screwdriver  
Screwdriver



### Fastening P.61

Screw bit  
Socket bit



Impact Driver



### Drilling (Wood/Metal) P.24

Drill bit with 1/4"Hex shank



4 Mode  
Impact Driver



### Drilling (Masonry) P.43

Masonry Bit with 1/4"Hex shank



Impact  
Wrench



### Fastening P.65

Socket      Extension bar  
Universal joint

Screw bit      Bit adapter assembly  
Socket bit



Auto Feed  
Screwdriver



### Fastening P.61

Screw bit



## Stirring

Power Mixer



### Miscellaneous P.188

Mixing blade



## Hammer drilling/Chiselling



Combination  
Hammer  
(3 Mode)



Rotary Hammer  
(2 Mode  
SDS PLUS Model)



Rotary  
Hammer  
(SDS Max  
Model)



Demolition  
Hammer



Power  
Scraper



Electric Breaker

### Drilling (Wood/Metal) P.20

Drill bit



Step drill bit & Countersink bit



Hole saw



### Diamond P.137

Diamond core bit (Dry type)



### Drilling (Masonry) P.51-57

Tungsten carbide-tipped bit



Bull point



Cold chisel



Grooving chisel



Scaling chisel



Scraper assembly 100  
(SDS-PLUS only)

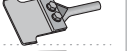

Clay spade



Bushing tool



Rammer



Ground rod adapter



## Cutting



Cutter

### Diamond P.125

Diamond wheel



Angle  
Cutter

### Bonded Abrasive P.96

Cut-off wheel



Portable  
Cut-off



Metal Cutter

### Cutting P.70

Carbide-tipped saw blade for Metal



Aluminum  
Groove Cutter

Grooving TCT Saw Blade



Portable Band Saw

### Jigsaw / Reciprosawing P.93

Band saw blade



# System Charts

## Grinding/Sanding/Polishing

Angle Grinder



### Bonded Abrasive P.96



### Coated Abrasive P.105

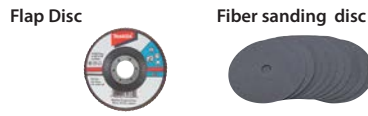

### Brushing P.94



### Diamond P.125



Die Grinder



### Bonded Abrasive P.104

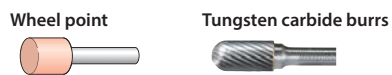

Disc Sander



### Coated Abrasive P.105

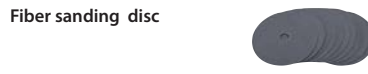

Belt Sander



Finishing Sander

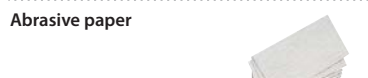

Random Orbit Sander

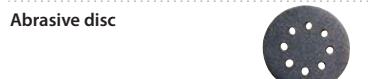

Polisher



### Brushing P.105

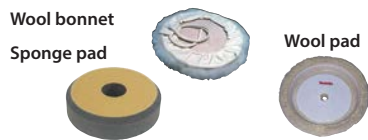

Stone Polisher

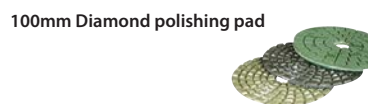

Wheel Sander



### Brushing P.94



Bench Grinder  
Straight Grinder



### Bonded Abrasive P.96



## Multifunction

Multi Tool



### Multi Tool P.115

Multi Tool  
Accessories



## Sawing

Slide Compound Miter Saw  
Circular Saw  
Table Saw



### Cutting P.70

Saw blade



Jig saw



### Jigsaw / Reciprosawing P.83

Jig saw blade



Reciprosaw



Reciprosaw blade



Band saw



Band saw blade



## Milling/Planing

Planer



### Planing / Routering P.138

Planer blade



Mini planer blade



Trimmer  
Router



Router bit



Concrete Planer



### Diamond P.136

Offset diamond wheel



## Outdoor Power Equipment



### P.144

Brushcutter blades



Chain blade

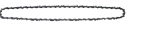

Shear blade



Nozzle



Nylon cutting head

## Miscellaneous



### Hand Tool, Pouches & Holders P.180



### Pneumatic Tool P.187

Nails



Staple



# Ideal for Cordless Tool Accessories



## What is Ideal for DC tool Accessories ?

Provides the greatest performance on DC tools!

Higher speed, more work amount on a single full battery charge and a nice sense of use.\* Here are the parties which give you the greatest performance on your MAKITA DC tools. You can find recommended accessories for DC tools with DC tool icons with an emphasized battery symbol. Try and see MAKITA's leading-edge technology.

\*Features may vary by item.





## TCT saw blade EFFICUT series

### EFFICUT

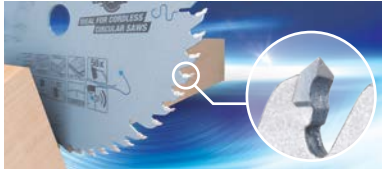

Efficient Sharp Tip's Top Angle



Efficient Curved Tip's Body



Efficient Slimmed Bottom



The amount of cutting per 1 charge

100

140% UP

240

### EFFICUT Composite decking

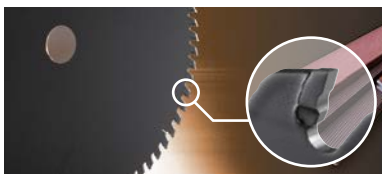

Efficient Curved Tip's Body



Efficient Slimmed Bottom

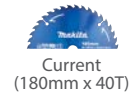

The amount of cutting per 1 charge

100

30% UP

130

### EFFICUT Metal



Strong and least chipping



Release swarf smoothly



Superior in straight cutting

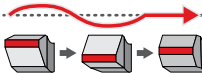

The amount of cutting per 1 charge

100

60% UP

160

### EFFICUT Aluminum



Strong and least chipping



Reduce cutting resistance



Superior in straight cutting

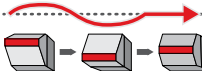

Release swarf smoothly



The amount of cutting per 1 charge

100

40% UP

140



### Diamond wheel for concrete

Specialized for 9inch DC Power Cutter

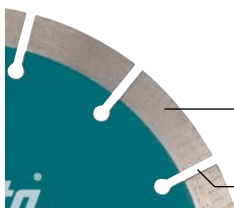

To reduce the cutting load, diamond grain size is designed small.

The narrower slits reduce dragging work pieces.

The amount of cutting per 1 charge

100

65% UP

165

### Cut-off wheel for Power cutter/ Metal / Ideal for Cordless Power cutter

Specialized for 14inch DC Power Cutter



Ideal blend of abrasive grain and bond for Cordless power cutter.

The amount of cutting per 1 charge

100

10% UP

110

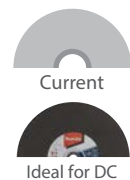



### Thin cut-off wheel

0.8mm thickness for fast cutting

**Thinner thickness**  
0.8mm thinner thickness brings ...  
fast cutting / reduction of cutting resistance / less burr  
of materials / less dust of materials

The amount of cutting per 1 charge

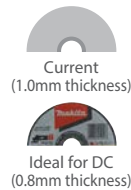

### 2in1 grinding wheel

Cutting and deburring are possible in one disc

**Specialized cutting work**  
Thanks to "SA"grid and 2.2mm thinner thickness, it  
enables you to cut fast and deburring safety.

The amount of cutting per 1 charge



### Flexible grinding wheel

Low vibration and no need back-up pad

**Shock absorbed structure**  
Added shock absorbing material. You can feel overwhelmingly  
low vibration. Grinding speed is also faster because of its  
flexibility. It can touch materials more efficiency.

The amount of cutting per 1 charge

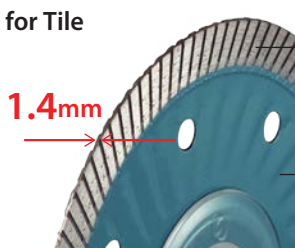
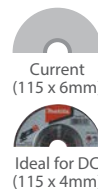

### Thin diamond wheel

Smooth & light cutting  
**Thinner thickness & enough strength**  
1.4mm thickness able to get smooth and light cutting.

Corrugated Rim increases wheel tension and  
reduces vibration during the cut.

The amount of cutting per 1 charge

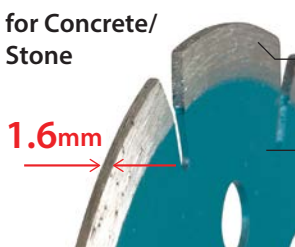
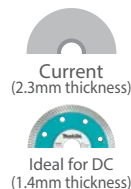

**Specialized cutting work**  
This blade is designed as 1.6mm.  
So smooth and light cutting is available.  
It was lightened by punching the body.  
It is also reduce the load on the battery and increased  
the cutting distance per 1 battery charge.

The amount of cutting per 1 charge

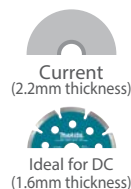

### Abrasive Cut-off wheel for metal stud

Specialized for 14inch DC Portable Cut-off

**Thinner blade & the optimum bonding**  
2.5mm thickness blade for smooth and fast cutting.  
The optimum bonding for fast cutting and longer life.

The amount of cutting per 1 charge

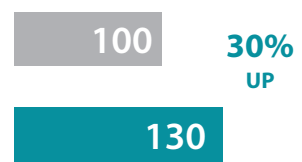
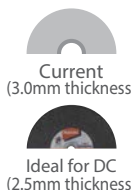



# Impact PREMIER



## High Precision Screw Fitting.



In a screw Near

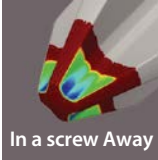

In a screw Away



Impact PREMIER

STANDARD

## New Steel is Used. Supports High Torque.

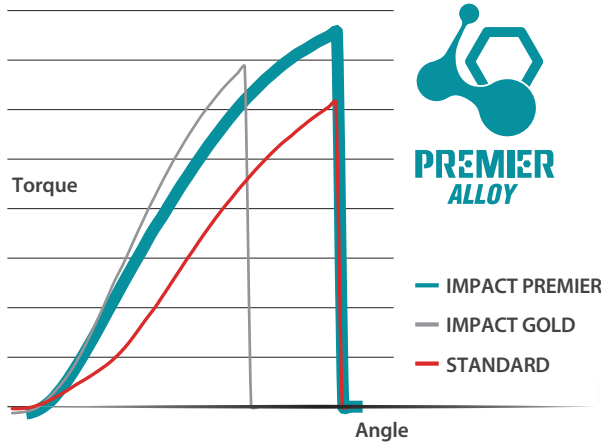

## Double Torsion for High Durability.



## Four-leaf Nylon cord Four-Leaf Line

Low noise and energy saving



### Round

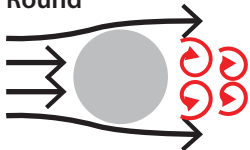

### Four-leaf

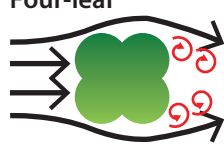

Four-leaf shape makes small vortex and realizes low noise and energy saving feature thanks to less air resistance.

### The amount of cutting per 1 charge

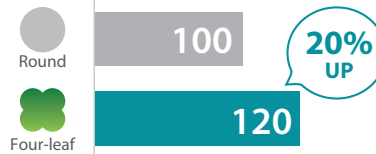

### Noise

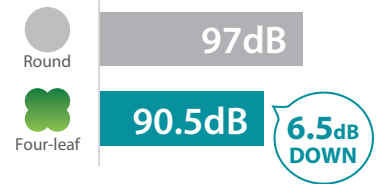

## 80 series saw chain

1. Optimum cutter shape for smooth cutting

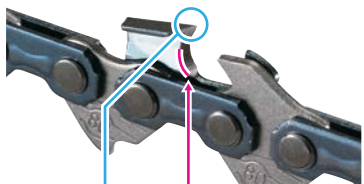

Sharp top angle

Deep-curved body

2. Short pitch for less vibration

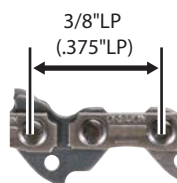

Current (90PX)

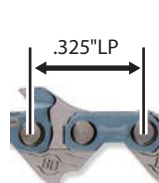

Ideal for DC (80series)

### The amount of cutting per 1 charge

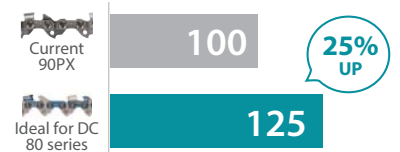

### Vibration

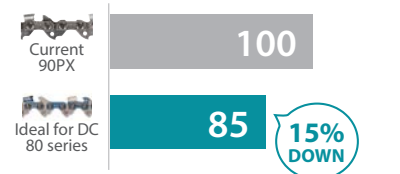



**Tool ↔ Battery ↔ Battery Charger**  
**Digital communication**

**XGT is a new system with its own tools, batteries, and chargers. A combination of innovative tool design and higher output batteries provide a genuine solution for high demand industrial users.**

**Optimum power supply system and Optimum charging system**

The XGT range of tools and batteries come with a built-in program, providing digital communication between the battery and tool. Allowing not only for the battery to talk with tool but also the tool to talk to the battery. Battery technology and motor engineering that work together for optimum performance.



**Optimum charging system**

Auto maintenance system with two cooling fans for providing more optimum fast charging

**Built Tough**

High durability specifications specially designed for 40Vmax Li-Ion batteries

4-LED fuel gauge indicator

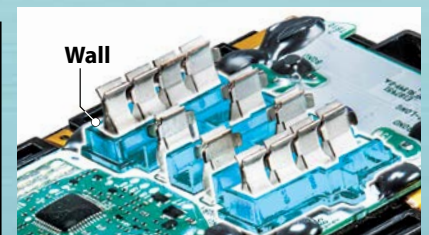
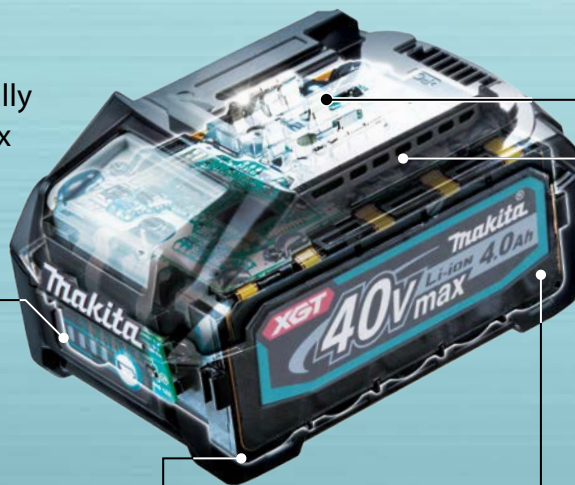

**Terminal short-circuit prevention structure**  
The protection wall is provided between terminals against water and dust.

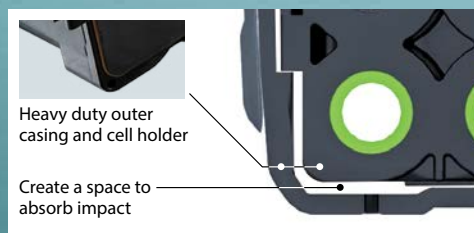

Heavy duty outer casing and cell holder  
Create a space to absorb impact

**Shock absorption structure**

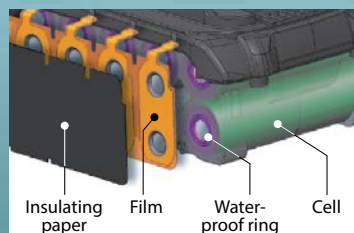

Insulating paper Film Water-proof ring Cell  
**Waterproof Triple-layer Structure**  
prevents cell failure due to water and dust.

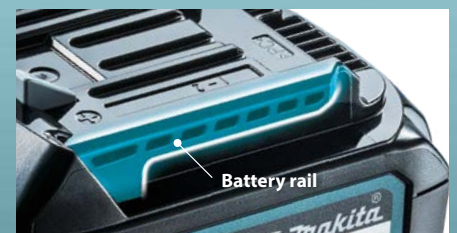

**High Rigidity Battery Rails**  
Durable slide in battery rail that holds the battery and the tools firmly and securely to withstand high power products

**40Vmax mechanism movie**

This movie was filmed in Japan.  
Models and specs may vary by country.



**Rapid Optimum Charging System**

It is necessary to cool down before start charging when the battery temperature is high.  
Built-in fan circulates air through the battery before start charging and during the charging process to cool the battery for faster charge time.

The Makita Rapid Optimum Charger communicates with the battery's built-in chip throughout the charging process to optimize battery life by actively controlling current, voltage and temperature.

**The optimum charging system**  
Forced air cooling



Fast charging



**General charging method**  
Natural heat dissipation

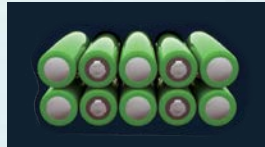

Waiting time for charging



**The optimum charging system**

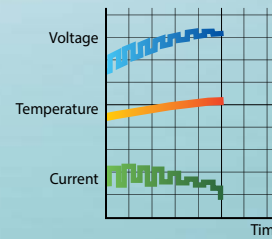

**General charging method**

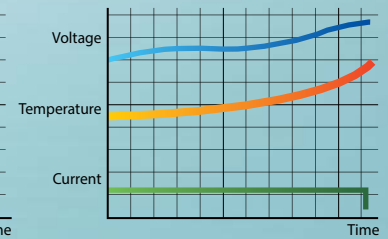

**Battery Protection Function**

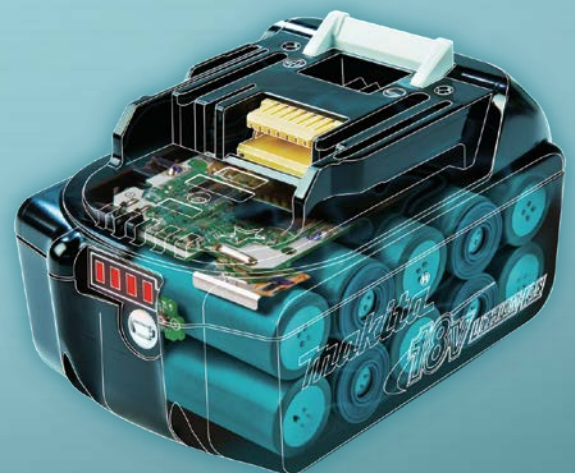
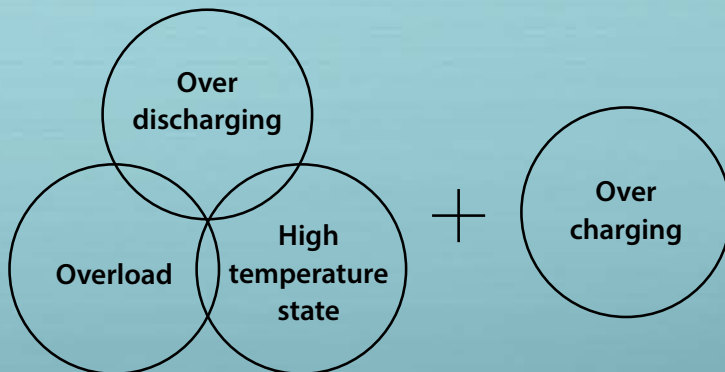

This function is communication technology that allows the tool and battery to monitor conditions and exchange data in real time to protect against Overload, Over-Discharge and Overheating.

**Firm Holding**

Multi-contact terminals reduce electrical resistance and increase connection stability withstanding against vibration, and ultimately ensures Stable current supply to the tool.

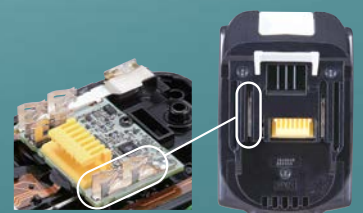



**Anytime Charge**  
No Memory Effect  
No discharging required



**Shock Absorbing**  
Heavy Duty Pack



# Li-ion Battery & Charger Time Reference, Compatibility Chart

40Vmax 18V		DC40RA (191E08-6) DC40RB* (191N14-5)	DC40RC (191M92-9)	DC40RA + ADP10 (191C11-5) Compatible with LXT Li-Ion batteries	DC40RC + ADP10 (191C11-5) Compatible with LXT Li-Ion batteries	DC18RC (195586-8) 110V - (195582-6) DC18RD* (196934-4) DC18RE** (198446-3)	DC18SD (194534-4) DC18SH* DC18SE (Automotive) (194621-9)	
40V max Lithium-ion <b>XGT</b>	8.0Ah BL4080F (191X65-8)	76min.	170min.	-	-	-	-	
	5.0Ah BL4050F (191L47-8)	50min.	85min.	-	-	-	-	
	4.0Ah BL4040F (1910N6-8) BL4040 (191B26-6)	45min.	67min.	-	-	-	-	
	2.5Ah BL4025 (191B36-3)	28min.	38min.	-	-	-	-	
	2.0Ah BL4020 (191L29-0)	22min.	30min.	-	-	-	-	
18V Lithium-ion <b>LXT</b>	6.0Ah BL1860B (197422-4)	-	-	40min.	85min.	55min.	130min.	
	5.0Ah BL1850B (197280-8)	-	-	35min.	70min.	45min.	110min.	
	4.0Ah BL1840B (197265-4)	-	-	29min.	58min.	36min.	90min.	
	3.0Ah BL1830B (197599-5)	-	-	22min.	42min.	22min.	60min.	
	2.0Ah BL1820B (197254-9)	-	-	24min.	33min.	24min.	45min.	
	1.5Ah BL1815N (196449-1)	-	-	15min.	22min.	15min.	30min.	
12V max Lithium-ion <b>CXT</b>	5.0Ah BL1050B (1913G0-9)	75min.	160min.	 40Vmax Lithium-ion 18V x2 Lithium-ion	35.5Ah PDC1200	360min.	 40Vmax Lithium-ion 18V x2 Lithium-ion 18V Lithium-ion Powered by up to four 18V LXT Batteries	
	4.0Ah BL1041B (197406-2)	60min.	130min.		43.55Ah PDC1500	450min.		
	2.0Ah BL1021B (197396-9)	30min.	70min.					
	1.5Ah BL1016 (197393-5)	22min.	50min.					
64V max Lithium-ion	10.0Ah BL64100 (191Y69-6)	300min.	10.8V Lithium-ion	1.5Ah BL1015K (1913U9-9)	55min.	18V Lithium-ion	1.5Ah BL1815G (198186-3)   BL1415G (198192-8)	70min.
	4.0Ah BL6440 (191R06-8)	120min.	7.2V Lithium-ion	1.3Ah BL1013 (196066-7)	50min.	14.4V Lithium-ion	2.0Ah BL1820G (191N69-0)	90min.
				1.5Ah BL0715 (198000-3)	35min.			

\* DC40RB / DC18RD / DC18SH: Two Port Multi Fast Charger \*\* DC18RE: CXT & LXT Dual port Fast Charger

## MAKPAC Power Source Kit



<b>QADPSKG1</b> (191V23-2)	Fast Charger (DC40RC), 2X40Vmax - 2.0Ah Batteries (BL4020), Makpac	
<b>QAEPSKG1</b> (191V31-3)	Fast Charger (DC40RC), 2X40Vmax - 2.5Ah Batteries (BL4025), Makpac	
<b>MKP1G001</b> (191J85-8)	Rapid Charger (DC40RA), 2X40Vmax - 2.5Ah Batteries (BL4025), Makpac	
<b>MKP1G002</b> (191K01-6)	Rapid Charger (DC40RA), 2X40Vmax - 4.0Ah Batteries (BL4040), Makpac	
<b>MKPPSKG2</b> (191V42-8)	Rapid Charger (DC40RA), 2X40Vmax - 5.0Ah Batteries (BL4050F), Makpac	
<b>QAAPSKG3</b> (191U06-6)	Dual Port Multi Rapid Charger (DC40RB), 2X40Vmax - 4.0Ah Batteries (BL4040), Makpac	
<b>QABPSKG3</b> (191U20-2)	Dual Port Multi Rapid Charger (DC40RB), 2X40Vmax - 5.0Ah Batteries (BL4050F), Makpac	
<b>QAPSKG3</b> (1910A2-5)	Dual Port Multi Rapid Charger (DC40RB), 2X40Vmax - 8.0Ah Batteries (BL4080F), Makpac	
<b>QACPSKG3</b> (191U34-1)	Dual Port Multi Rapid Charger (DC40RB), 4X40Vmax - 4.0Ah Batteries (BL4040), Makpac	
<b>QADPSKG3</b> (191U48-0)	Dual Port Multi Rapid Charger (DC40RB), 4X40Vmax - 5.0Ah Batteries (BL4050F), Makpac	

## MAKPAC Power Source Kit



<b>MKP1RF182</b> (197974-5)	Rapid Charger (DC18RC), 2X18V - 3.0Ah Batteries (BL1830B), Makpac	
<b>MKP1RT182</b> (197803-2)	Rapid Charger (DC18RC), 2X18V - 5.0Ah Batteries (BL1850B), Makpac	
<b>MKP1RG182</b> (198119-8)	Rapid Charger (DC18RC), 2X18V - 6.0Ah Batteries (BL1860B), Makpac	
<b>MKP3PT182</b> (198182-1)	Dual Port Rapid Charger (DC18RD), 2X18V - 5.0Ah Batteries (BL1850B), Makpac	
<b>MKP3PG182</b> (198081-7)	Dual Port Rapid Charger (DC18RD), 2X18V - 6.0Ah Batteries (BL1860B), Makpac	
<b>MKP3PT184</b> (197627-6)	Dual Port Rapid Charger (DC18RD), 4X18V - 5.0Ah Batteries (BL1850B), Makpac	
<b>MKP3PG184</b> (198095-6)	Dual Port Rapid Charger (DC18RD), 4X18V - 6.0Ah Batteries (BL1860B), Makpac	

## MAKPAC Power Source Kit



<b>MKP1SY122</b> (197654-3)	Fast Charger (DC10SB), 2X12Vmax - 1.5Ah Batteries (BL1016), Makpac	
<b>MKP1SA122</b> (191K13-9)	Fast Charger (DC10SB), 2X12Vmax - 2.0Ah Batteries (BL1021B), Makpac	
<b>MKP1SM122</b> (191K12-1)	Fast Charger (DC10SB), 2X12Vmax - 4.0Ah Batteries (BL1041B), Makpac	

**XGT**

# 40V Li-ion max

High Power

Durability

Digital Communication

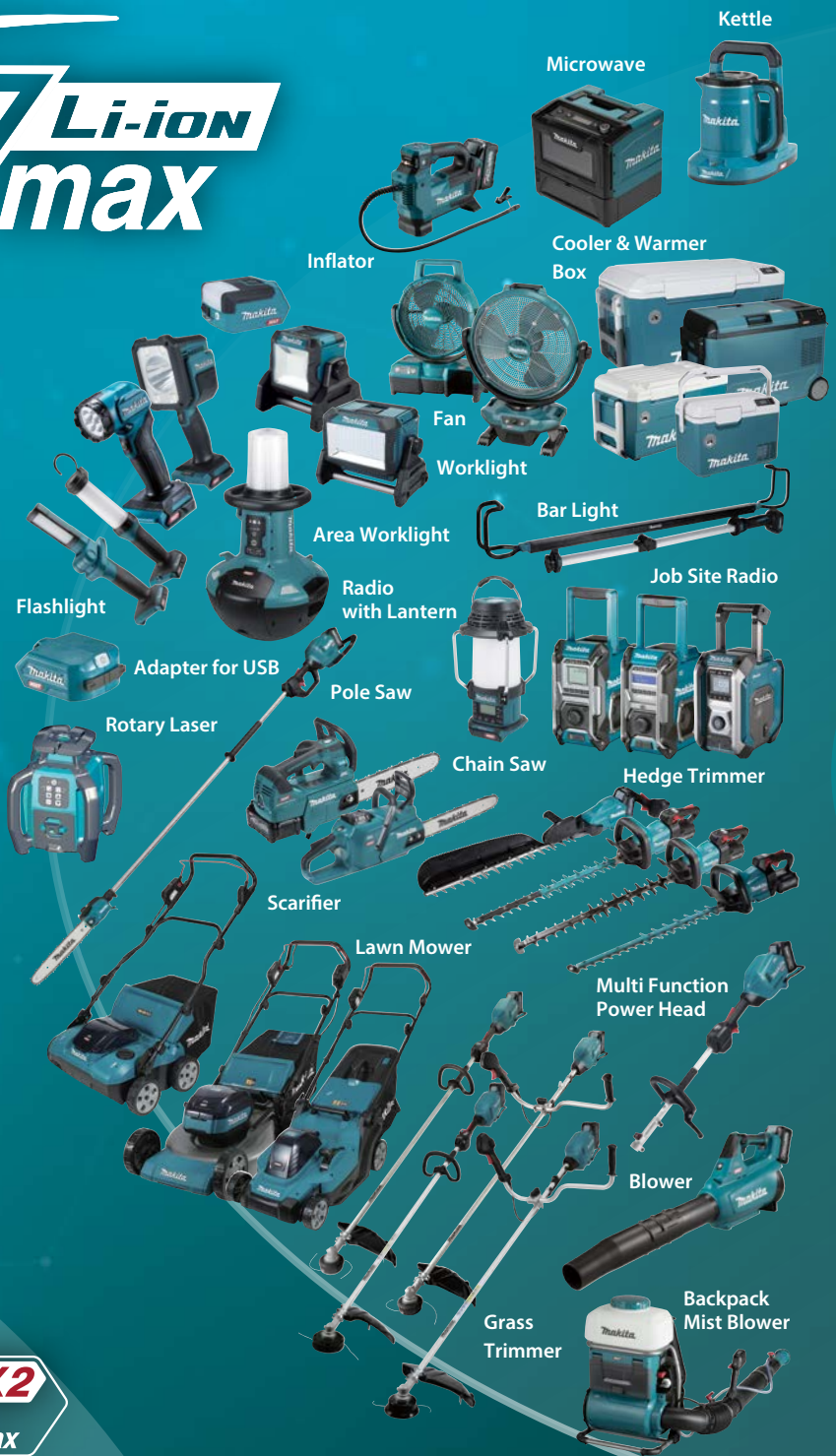

**XGT**

# 40V Li-ion max

**XGT X2**  
80V max



Rotary Hammer



Demolition Hammer



Power Cutter



Breaker



Grass Trimmer



Vacuum Cleaner

## Battery

BL4020  
2.0Ah

BL4025 /  
BL4025F  
2.5Ah

BL4040 /  
BL4040F  
4.0Ah





^ Some models are not for local sale

### Charger

**BL4050F**  
5.0Ah

**BL4080F**  
8.0Ah

**DC40RA**

**DC40RB**

**DC40WA**

**DC40RC**

**ADP10**



Adapter for LXT Battery

# 18V LITHIUM-ION



# LXT

Portable Cut-off

Power Cutter

Angle Grinder

Plunge Cut Saw

Recipro Saw

Rotary Hammer

Combination Hammer

Slide Compound Miter Saw

Slide Compound Miter Saw

Slide Compound Miter Saw

Slide Compound Miter Saw

Slide Compound Miter Saw

Slide Compound Miter Saw

Slide Compound Miter Saw

Slide Compound Miter Saw

Slide Compound Miter Saw

Slide Compound Miter Saw

Slide Compound Miter Saw

Slide Compound Miter Saw

Slide Compound Miter Saw

Slide Compound Miter Saw

Slide Compound Miter Saw

Slide Compound Miter Saw

Slide Compound Miter Saw

Slide Compound Miter Saw

Slide Compound Miter Saw

Slide Compound Miter Saw

Slide Compound Miter Saw

Slide Compound Miter Saw

Slide Compound Miter Saw

Slide Compound Miter Saw

Slide Compound Miter Saw

Slide Compound Miter Saw

Slide Compound Miter Saw

Slide Compound Miter Saw

Slide Compound Miter Saw

Slide Compound Miter Saw

Slide Compound Miter Saw

Slide Compound Miter Saw

Slide Compound Miter Saw

Slide Compound Miter Saw

Slide Compound Miter Saw

Slide Compound Miter Saw

Slide Compound Miter Saw

Slide Compound Miter Saw

Slide Compound Miter Saw

Wall Scanner

Caulking Gun

Vacuum Pump

Grease Gun

Cooler & Warmer Box

Coffee Maker

Inflator

Fan

LED Worklight

Radio with Lantern

Job Site Radio

Job Site Radio

Job Site Radio

Job Site Radio

Job Site Radio

Job Site Radio

Job Site Radio

Job Site Radio

Job Site Radio

Job Site Radio

Job Site Radio

Job Site Radio

Job Site Radio

Job Site Radio

Job Site Radio

Job Site Radio

Job Site Radio

Job Site Radio

Fan Jacket

Heated Jacket

Fan Vest

Heated Vest

Heated Blanket

Worklight

Bar Light

Flashlight

LED Flashlight

Pruning Shears

Pruning Saw

Blower

Blower Vacuum

Brad Nailer

Planer

Trimmer

Grass Shear

Garden Sprayer

String Trimmer

Robotic Cleaner

Cleaner

Vacuum Cleaner

Rebar Tying Tool

Rivet Gun

Drywall Saw

Circular Saw

Stapler

Cut-Out Tool

Pin Nailer

Finish Nailer

Plate Joiner

Jig Saw

Heat Gun

Heat Gun

Heat Gun

Heat Gun

Heat Gun

Heat Gun

Heat Gun

Heat Gun

Heat Gun

Heat Gun

Heat Gun

Heat Gun

Heat Gun

Heat Gun

Heat Gun

Heat Gun

Heat Gun

Heat Gun

Heat Gun

Heat Gun

Heat Gun

Heat Gun

Heat Gun

Heat Gun

Heat Gun

Heat Gun

Heat Gun

Heat Gun

Heat Gun

Heat Gun

Heat Gun

Heat Gun

Heat Gun

Heat Gun

Heat Gun

Heat Gun

Heat Gun

Heat Gun

Heat Gun

Heat Gun

Heat Gun

Heat Gun

Heat Gun

Heat Gun

Heat Gun

Heat Gun

Heat Gun

Heat Gun

Heat Gun

Heat Gun

Heat Gun

Heat Gun

Heat Gun

Heat Gun

Heat Gun

Heat Gun

Heat Gun

Heat Gun

Heat Gun

Heat Gun

Heat Gun

Heat Gun

Heat Gun

Heat Gun

Heat Gun

Heat Gun

Heat Gun

Heat Gun

Heat Gun

Heat Gun

Heat Gun

Heat Gun

Heat Gun

Heat Gun

Heat Gun

Heat Gun

Heat Gun

Heat Gun

Heat Gun

Heat Gun

Heat Gun

Heat Gun

Heat Gun

Heat Gun

Heat Gun

Heat Gun

Heat Gun

Heat Gun

Heat Gun

Heat Gun

Heat Gun

Heat Gun

Heat Gun

Heat Gun

Heat Gun

Heat Gun

Heat Gun

Heat Gun

Heat Gun

Heat Gun

Heat Gun

Heat Gun

Heat Gun

Heat Gun

Heat Gun

Heat Gun

Heat Gun

Heat Gun

Heat Gun

Heat Gun

Heat Gun

Heat Gun

Heat Gun

Heat Gun

Heat Gun

Heat Gun

Heat Gun

Heat Gun

Heat Gun

Heat Gun

Heat Gun

Heat Gun

Heat Gun

Heat Gun

Heat Gun

Heat Gun

Heat Gun

Heat Gun

Heat Gun

Heat Gun

Heat Gun

Heat Gun

Heat Gun

Heat Gun

Heat Gun

Heat Gun

Heat Gun

Heat Gun

Heat Gun

Heat Gun

Heat Gun

Heat Gun

Heat Gun

Heat Gun

Heat Gun

Heat Gun

Heat Gun

Heat Gun

Heat Gun

Heat Gun

Heat Gun

Heat Gun

Heat Gun

Heat Gun

Heat Gun

Heat Gun

Heat Gun

Heat Gun

Heat Gun

Heat Gun

Heat Gun

Heat Gun

Heat Gun

Heat Gun

Heat Gun

Heat Gun

Heat Gun

Heat Gun

Heat Gun

Heat Gun

Heat Gun

Heat Gun

Heat Gun

Heat Gun

Heat Gun

Heat Gun

Heat Gun

Heat Gun

Heat Gun

Heat Gun

Heat Gun

Heat Gun

Heat Gun

Heat Gun

Heat Gun

Heat Gun

Heat Gun

Heat Gun

Heat Gun



Chain Saw

Pole Saw

Grass Trimmer

Pruning Shears

Earth Auger

Lawn Mower

Vacuum Pump

High Pressure Washer

Wheelbarrow

Portable Power Pack

Impact Wrench

Vacuum Cleaner

Blower

Kettle

Hedge Trimmer

Multi Function Power Head

Concrete Vibrator

Mixer

4 Mode Impact Driver

Screwdriver

Driver Drill

Oil-Pulse Driver

Auto Feed Screwdriver

Angle Impact Wrench

Impact Driver

Angle Drill

Angle Impact Driver

Ratchet Wrench

Hammer Driver Drill

Rotary Hammer

Die Grinder

Sander Polisher

Power Scraper

Combination Hammer

Steel Rod Cutter

Multi Tool

Random Orbit Polisher

Angle Grinder

Recipro Saw

Metal Shear

Finishing Sander

Drywall Sander

Random Orbit Sander

Threaded Rod Cutter

Compact Cut Off

Hole Puncher

Belt Sander

Nibbler

Cable Cutter

Cutter

Metal Cutter

Portable Band Saw

Slide Compound Miter Saw

Compound Miter Saw

18V x2

440+ TOOLS

6.0Ah 5.0Ah 4.0Ah 3.0Ah 2.0Ah 1.5Ah

^ Some models are not for local sale

Expand Your Lithium Line Up



# A wide variety of Lithium-ion Garden Tools

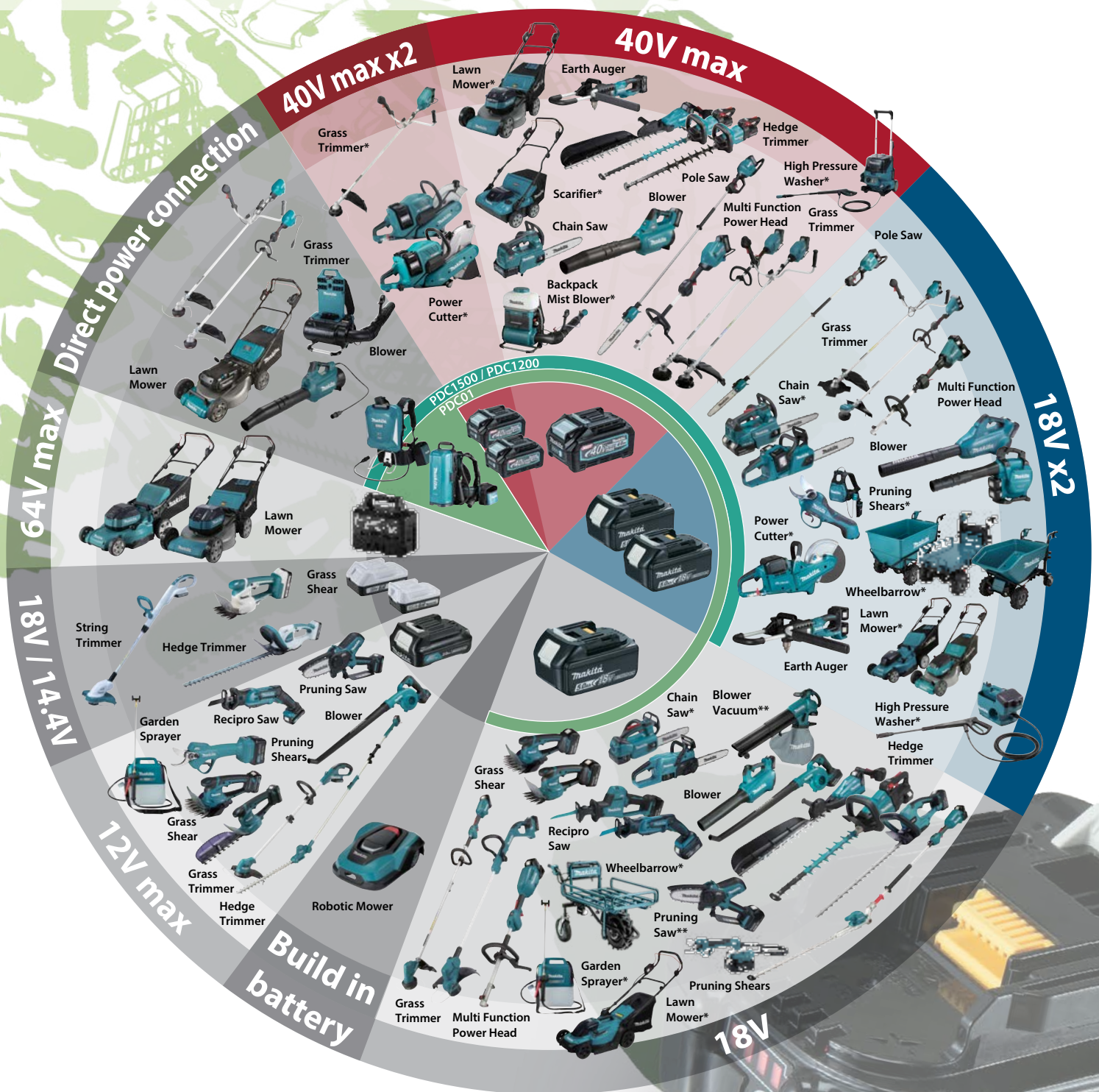

\* These models are not compatible with Portable Power Pack (PDC1500, PDC1200, PDC01)  
 Only rear handle type chainsaws are compatible  
 \*\* These models are not compatible with Portable Power Pack (PDC1500, PDC1200)  
 ^ Some models are not for local sale



## Makita Cordless Part Number Breakdown

<b>DSE</b>	Charger (DC10WA), 2X7.2V - 1.0Ah Batteries (BL7010)	
<b>DW</b>	Charger (DC10WA), 1X10.8V - 1.3Ah Battery (BL1013)	
<b>DWE</b>	Charger (DC10WA), 2X10.8V - 1.3Ah Batteries (BL1013)	
<b>DWYE</b>	Standard Charger (DC10WD), 2X12Vmax - 1.5Ah Batteries (BL1016)	
<b>DSYE</b>	Fast Charger (DC10SB), 2X12Vmax - 1.5Ah Batteries (BL1016)	
<b>DSAE</b>	Fast Charger (DC10SB), 2X12Vmax - 2.0Ah Batteries (BL1021B)	
<b>DSAJ</b>	Fast Charger (DC10SB), 2X12Vmax - 2.0Ah Batteries (BL1021B), Makpac	
<b>DSME</b>	Fast Charger (DC10SB), 2X12Vmax - 4.0Ah Batteries (BL1041B)	
<b>SYE</b>	Standard Charger (DC18SD), 2X18V - 1.5Ah Batteries (BL1815B)	
<b>RYE</b>	Rapid Charger (DC18RC), 2X18V - 1.5Ah Batteries (BL1815B)	
<b>SF</b>	Standard Charger (DC18SD), 1X18V - 3.0Ah Battery (BL1830B)	
<b>RF</b>	Rapid Charger (DC18RC), 1X18V - 3.0Ah Battery (BL1830B)	
<b>RFE/ RF2</b>	Rapid Charger (DC18RC), 2X18V - 3.0Ah Batteries (BL1830B)	
<b>RFJ</b>	Rapid Charger (DC18RC), 2X18V - 3.0Ah Batteries (BL1830B), Makpac	
<b>RME</b>	Rapid Charger (DC18RC), 2X18V - 4.0Ah Batteries (BL1840B)	
<b>RTE/ RT2</b>	Rapid Charger (DC18RC), 2X18V - 5.0Ah Batteries (BL1850B)	
<b>RTJ</b>	Rapid Charger (DC18RC), 2X18V - 5.0Ah Batteries (BL1850B), Makpac	
<b>PT2</b>	Dual Port Rapid Charger (DC18RD), 2X18V - 5.0Ah Batteries (BL1850B)	
<b>PG2J</b>	Dual Port Rapid Charger (DC18RD), 2X18V - 6.0Ah Batteries (BL1860B), Makpac	
<b>G2</b>	2X18V - 6.0Ah Batteries (BL1860B)	

### Makita Coding System - Ending Alphabet

**DDF484 R T E**

#### Charger

**S** - Standard Charger  
**R** - Rapid (Fast) Charger  
**P** - Two Port Charger

#### Come with Battery

**H** - 1.3Ah    **M** - 4.0Ah  
**Y** - 1.5Ah    **T** - 5.0Ah  
**A** - 2.0Ah    **G** - 6.0Ah  
**D** - 2.5Ah    **L** - 8.0Ah  
**F** - 3.0Ah

Comes with  
2 batteries

**Other:**  
**B** - Double Insulation  
**C** - Electronic Control  
**F** - LED Light  
**K** - Carrying Case  
**2** - 18V x 2 Tools

**Z**









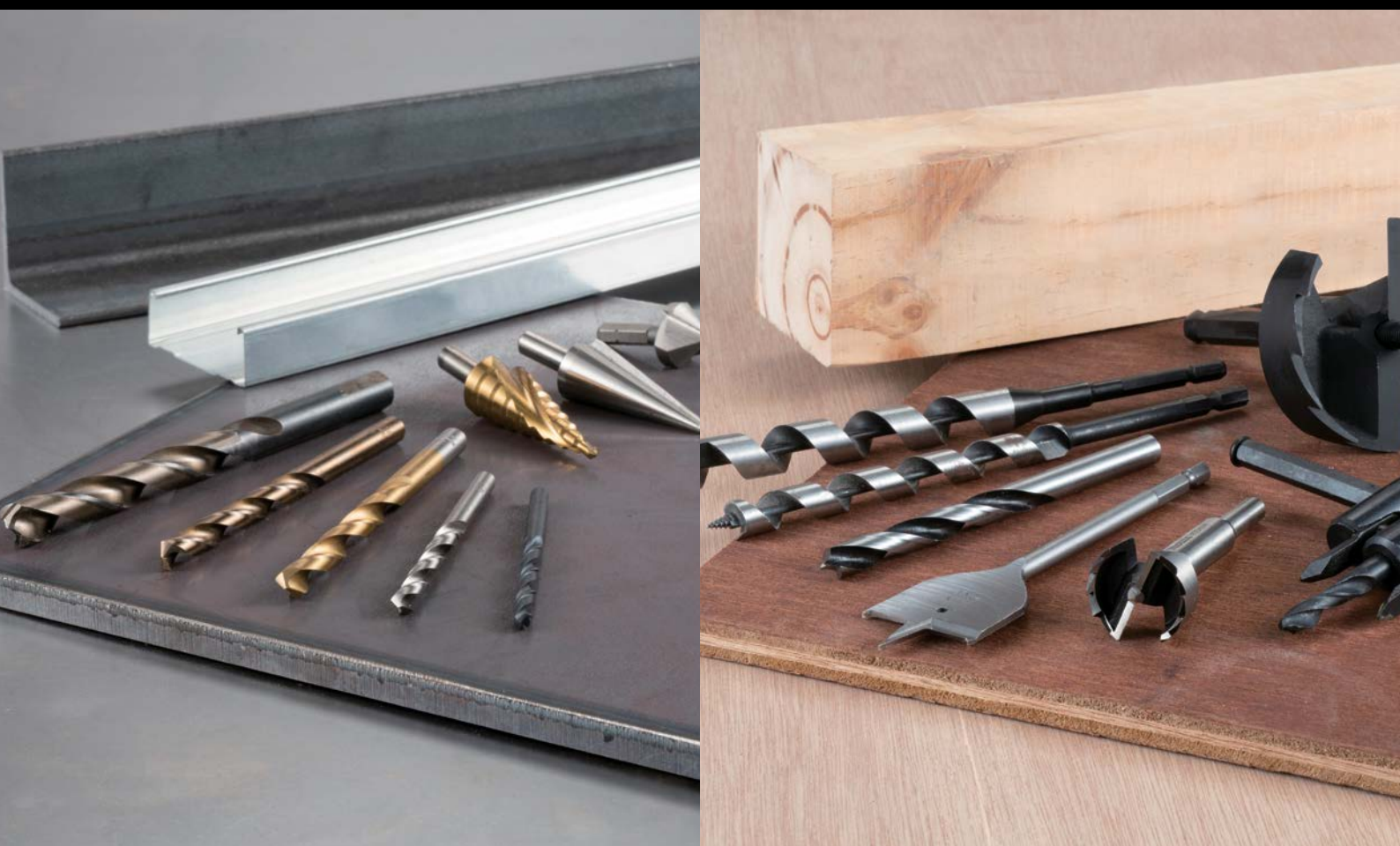























Tool come with  
carton box only

For more information, please contact Makita authorised distributor's technical team.

# ACCESSORIES

## Drilling (Wood/Metal)



 Metal, mild steel	 Stainless steel	 Aluminum	 Non-ferrous metal	 Wood	 Wood with nails	 MDF
 Plywood	 Soft Tile	 Brick	 Soft brick	 Marble	 Limestone	 Plaster board
 Plastic	 Fiberglass	 Sheet metal	 Tungsten carbide tip for glass bit	 Glass	 Long life	 Fast cut
 Do not drill with impact	 Oil	 Wet	 n max. 10000	 Chisel edge	 M shape	 Split point
 Cylindrical shank	 Three flat shank	 Hex shank	 C-form 6.35 Hex shank C-form	 MZ 6.35 Hex shank MZ		

# Drilling (Wood / Metal)

## HSS metal drill bit series

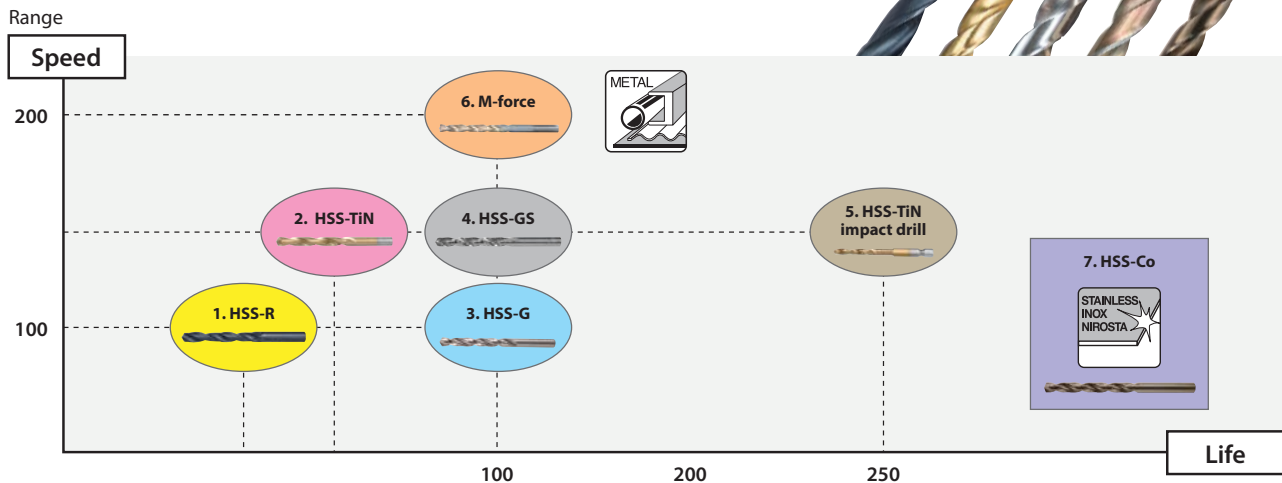
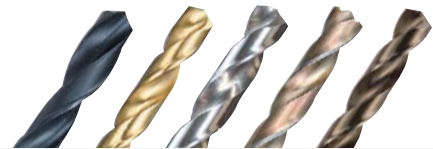

No.	1	2	3	4	5	6	7
Range	★	★★	★★★	★★★★	★★★★★	★★★★★	Specialized
Series							
Description							
Made of							
Process of manufacturing *	Roll forged 	Ground 					
Tip geometry **	Chisel edge 118° 	Split point 135° 	Chisel edge 118° 	Split point 135° 	M-shape 		Split point 135° 
Surface	Black oxide finish  Anti-rust	TiN coating  Long life	Bright finish 		TiN coating  Long life	Amber finish  Anti-rust	
Shank	Straight (Cylindrical) 				1/4"Hex (E-form) 	Straight (Three flat)  Better grip than Cylindrical shank	Straight (Cylindrical) 

AA : Recommended

A : Acceptable

No.	1	2	3	4	5	6	7
Material	Wood	A	A	A	A	A	A
	Plastic	AA	AA	AA	AA	AA	AA
	Non-ferrous metal***		AA	AA	AA	AA	AA
	Sheet steel	A	AA	AA	AA	AA	AA
	Cast iron	A	A	AA	AA	AA	AA
	Alloy steel		A	AA	AA	AA	AA
	Stainless steel		A	A	A	A	A

\* Roll forged: Made by die-casted rolling machine. It is economical price.  
Ground: Drill bits ground from the block with excellent surface quality.

\*\* 135°split point: Ensure no walking and start fast, on contact.  
M-shape: Designed to focus on drilling smoothly and speedily.

\*\*\* Non-ferrous metal (Such as Copper, Nickel and Zinc)

# Drilling (Wood / Metal)

## HSS metal drill bit line up

Series	Shank	Single pkg.	Set	Assortment		
		1pc. / 2pcs.	5pcs. / 10pcs.			
HSS-R	Straight (Cylindrical)	 1pc. / 2pcs.	 5pcs. / 10pcs. set	 13pcs. set	 19pcs. set	 25pcs. set
HSS-TiN	Straight (Cylindrical)	 1pc. / 2pcs.	 5pcs. / 10pcs. set	 19pcs. set	 19pcs. set	
HSS-G	Straight (Cylindrical)	 1pc.	 5pcs. / 10pcs. set	 6pcs. set	 19pcs. set	 25pcs. set
HSS-GS	Straight (Cylindrical)	 1pc.	 5pcs. / 10pcs. set	 6pcs. set	 19pcs. set	 25pcs. set
HSS-TiN	1/4" Hex (E-form)	 1pc.			 5pcs. set	
M-force	Straight (Three flat)	 1pc.		 19pcs. set	 25pcs. set	
HSS-Co	Straight (Cylindrical)	 1pc.	 5pcs. set	 6pcs. set	 19pcs. set	 25pcs. set



# Drilling (Wood / Metal)

## HSS-R metal drill bit



Diameter (mm)	Length (mm)	Working Length (mm)	Sales Pkg Qty	Part No.
6.8	109	69	1	D-46953
8.8	125	81	1	D-46969
10.3	133	87	1	D-46975
10.8	142	94	1	D-46981

## HSS-TiN metal drill bit economy



Diameter (mm)	Length (mm)	Working Length (mm)	1pc.	2pcs.	5pcs.	10pcs
			Part No.	Part No.	Part No.	Part No.
1	34	12	-	D-64004	-	-
1.5	40	18	-	D-64010	-	-
2	49	24	-	D-64026	-	D-64272
2.5	57	30	-	D-64032	-	-
3	61	33	-	D-64048	-	D-64294
3.5	70	39	-	D-64054	-	D-64303
4	75	43	-	D-64060	-	D-64319
4.5	80	47	D-64076	-	-	-
5	86	52	D-64082	-	-	-
5.5	93	57	D-64098	-	-	D-64347
6	93	57	D-64107	-	-	D-64353
6.5	101	63	D-64113	-	-	D-64369
7	109	69	D-64129	-	-	D-64375
7.5	109	69	D-64135	-	-	D-64381
8	117	75	D-64141	-	-	D-64397
8.5	117	75	D-64157	-	-	-
9	125	81	D-64163	-	-	-
9.5	125	81	D-64179	-	D-64428	-
10	133	87	D-64185	-	D-64434	-
10.5	133	87	D-64191	-	D-64440	-
11	142	94	D-64200	-	D-64456	-
11.5	142	94	D-64216	-	D-64462	-
12	151	101	D-64222	-	-	-
12.5	151	101	D-64238	-	D-64484	-
13	151	101	D-64244	-	-	-
14	160	108	D-65741	-	-	-
15	169	114	D-65757	-	-	-
16	178	120	D-65763	-	-	-
17	184	125	D-65779	-	-	-
18	191	130	D-65785	-	-	-
19	198	135	D-65791	-	-	-
20	205	140	D-65800	-	-	-

## HSS-TiN 5pcs., 10pcs. metal drill bit economy



Diameter	Length	Working Length	Sales Pkg Qty	Part No.
1/16"	1-7/8"	7/8"	10	D-64799
1/8"	2-3/4"	1-5/8"	10	D-64836
9/64"	2-7/8"	1-3/4"	10	D-64842
5/32"	3-1/8"	2"	10	D-64858
3/16"	3-1/2"	2-5/16"	10	D-64870
1/4"	4"	2-3/4"	10	D-64901
5/16"	4-1/2"	3-3/16"	10	D-64917
3/8"	5"	3-5/8"	5	D-64923
7/16"	5-1/2"	4-1/16"	5	D-64939
1/2"	6"	4-1/2"	5	D-64945

## HSS-TiN metal drill bit economy set



Diameter (mm)	Sales Pkg Qty	Part No.
1.5 to 10	19	B-67795
1 to 10	19	D-72229

## HSS metal drill bit set



Diameter (mm)	Sales Pkg Qty	Part No.
4, 5, 6, 8, 10	5	D-30514

# Drilling (Wood / Metal)

## HSS-TiN metal drill bit with 1/4" Hex shank



Type NZ

Diameter (mm)	Length (mm)	Working Length (mm)	Sales Pkg Qty	Part No.
2.5	78	30	1	D-46539
3.0	91	33	1	D-31114
3.3	95	36	1	D-31136
4.0	105	43	1	D-31142
4.2	105	43	1	D-31164
5	116	52	1	D-31170
5.2	102	52	1	D-46545
6	123	57	1	D-31186
6.5	131	63	1	D-31192
8	117	75	1	D-31201
10	133	87	1	D-31217
12	151	101	1	D-31223
13	151	101	1	D-31239

## HSS-G metal drill bit



Diameter (mm)	Length (mm)	Working Length (mm)	1pc.	5pcs.	10pcs.
			Part No.	Part No.	Part No.
1.5	40	18	D-09656	-	D-06236
1.75	46	22	-	-	D-06242
2	49	24	D-09662	-	-
2.25	53	27	-	-	D-06264
2.5	57	30	D-09678	-	-
2.75	61	33	-	-	D-06286
2.9	61	33	D-46816	-	D-46648
3	61	33	D-09684	-	-
3.2	65	36	D-46589	-	D-34942
3.25	65	36	-	-	D-06301
3.3	65	36	D-46595	-	-
3.5	70	39	D-09690	-	-
3.75	70	39	-	-	D-06323
4	75	43	D-09709	-	-
4.25	75	43	-	-	D-06345
4.5	80	47	D-09715	-	D-06351
4.75	80	47	-	-	D-06367
5	86	52	D-09721	-	-
5.2	86	52	D-46610	-	D-34986
5.3	86	52	D-46822	-	-
5.5	93	57	D-09737	-	-
6	93	57	D-09743	-	-
6.25	101	63	-	-	D-06426
6.5	101	63	D-09759	-	-
6.75	109	69	-	-	D-06448
6.8	109	69	D-46838	-	-
7	109	69	D-09765	-	-
7.25	109	69	-	-	D-06460
7.5	109	69	D-09771	-	D-06476
7.75	117	75	-	-	D-06482
8	117	75	D-09787	-	-
8.5	117	75	-	-	-
8.75	125	81	-	D-06529	-
8.8	125	81	D-46844	-	-
9	125	81	D-09802	-	-
9.5	125	81	D-09818	D-06557	-
10	133	87	D-09824	-	-
10.3	133	87	D-46850	-	-
10.5	133	87	D-09830	-	-
10.8	142	94	D-46866	-	-
11	142	94	D-09846	-	-
11.5	142	94	D-09852	-	-
12	151	101	D-09868	-	-
12.5	151	101	D-09874	D-06638	-
13	151	101	D-09880	-	-

## HSS-TiN impact drill bit for SDS-PLUS Hammers



Type NZ

Diameter (mm)	Length (mm)	Working Length (mm)	Sales Pkg Qty	Part No.
3	90	33	1	B-57401
3.5	100	39	1	B-57417
4	105	43	1	B-57423
4.5	110	47	1	B-57439
5	116	52	1	B-57445
5.5	123	57	1	B-57451
6	12	57	1	B-57467
6.5	131	63	1	B-57473

# Drilling (Wood / Metal)

## HSS-G 5pcs, 10pcs. metal drill bit set



Size: inch

Diameter	Length	Working Length	Sales Pkg Qty	Part No.
1/8"	2-3/4"	1-5/8"	10	D-21989
5/32"	3-1/8"	2"	10	D-22006
3/16"	3-1/2"	2-5/16"	10	D-22028
5/16"	4-1/2"	3-3/16"	10	D-22109
3/8"	5"	3-5/8"	10	D-37219
1/2"	6"	4-1/2"	5	D-22224

## HSS-GS metal drill bit set



Range	Work Material	Bit dia. (mm)	Sales Pkg Qty	Part No.
★★★★☆	Metal/Metric	2 to 8	6	D-78346
		1 to 10	19	D-78352
		1 to 13	25	D-78368

## Rivet drill bit 1/4" Hex. shank



Type MZ

Diameter (mm)	Length (mm)	Working Length (mm)	Sales Pkg Qty	Part No.
3.3	50	25	5	B-38869 / B-56437(new)





# Drilling (Wood / Metal)

## M-Force HSS metal drill bit



Diameter (mm)	Length (mm)	Working Length (mm)	Sales Pkg Qty	Part No.
2	49	24	1	D-29614
2.5	57	30	1	D-29620
3.0	61	33	1	D-29636
3.2	65	36	1	D-37633
3.3	65	36	1	D-46626
3.5	70	39	1	D-29642
4.0	75	43	1	D-29658
4.2	75	43	1	D-37649
4.5	80	47	1	D-29664
5	86	52	1	D-29670
5.2	86	52	1	D-37655
5.5	93	57	1	D-29686
6	93	57	1	D-29692
6.5	101	63	1	D-29701
7	109	69	1	D-29717
7.5	109	69	1	D-29723
8	117	75	1	D-29739
8.5	117	75	1	D-29745
9	125	81	1	D-29751
9.5	125	81	1	D-29767
10	133	87	1	D-29773
10.5	133	87	1	D-29789
11	142	94	1	D-29795
11.5	142	94	1	D-29804
12	151	101	1	D-29810
12.5	151	101	1	D-29826
13	151	101	1	D-29832



## HSS-Co metal drill bit (Cobalt 5%)



Diameter (mm)	Length (mm)	Working Length (mm)	1pc.	5pcs.
			Part No.	Part No.
1.5	40	18	D-17289	-
1.75	46	22	-	-
2	49	24	D-17295	D-16623
2.5	57	30	D-17304	D-16639
3.0	61	33	D-17310	D-16645
3.2	65	36	D-17326	-
3.3	65	36	D-46660	-
3.5	70	39	D-17332	D-16667
4.0	75	43	D-17348	-
4.2	75	43	D-46676	-
4.5	80	47	D-17354	D-16689
5	86	52	D-17360	D-16695
5.2	86	52	D-46682	-
5.5	93	57	D-17376	D-16704
6	93	57	D-17382	-
6.5	101	63	D-17398	-
7	109	69	-	D-16732
7.5	109	69	D-17413	-
8	117	75	D-17429	D-16754
8.5	117	75	D-17435	-
9	125	81	D-17441	D-16776
10	133	87	D-17463	-
10.5	133	87	D-17479	D-16807
11	142	94	D-17485	D-16813
11.5	142	94	D-17491	D-16829
12	151	101	D-17500	-
12.5	151	101	D-17516	D-16841
13	151	101	D-17522	-

# Drilling (Wood / Metal)

## M-Force HSS metal drill bit set

4-star range  
★★★★



Diameter (mm)	Sales Pkg Qty	Part No.
4, 5, 6, 8, 10	5	D-30508
1 to 10	19	D-67583
1 to 13	25	D-67599

## HSS-Co metal drill bit assortment



Diameter (mm)	Sales Pkg Qty	Part No.
2, 3, 4, 5, 6, 8mm (1pc.each)	6pc. Assortment	D-75758

## Double ended drill bit



Diameter (mm)	Length (mm)	Working Length (mm)	Sales Pkg Qty	Part No.
2	38	7.5	10	B-26652
3.0	46	10.6	10	B-26668
3.1	49	11	10	B-26674
3.2	49	11	10	B-26680
3.3	49	11	10	B-26696
3.5	52	13	10	B-26705
3.8	55	14	10	B-26711
4.0	55	14	10	B-26727
4.2	55	14	10	B-26749
4.3	55	14	10	B-26755
4.5	58	16	10	B-26761
4.8	62	17	10	B-26777
4.9	62	17	10	B-26783
5.1	62	17	10	B-26808
5.2	62	17	10	B-26814
5.5	66	19	10	B-26820
6	66	19	10	B-26836
6.5	70	21	10	B-33788



# Drilling (Wood / Metal)

## Step drill bit

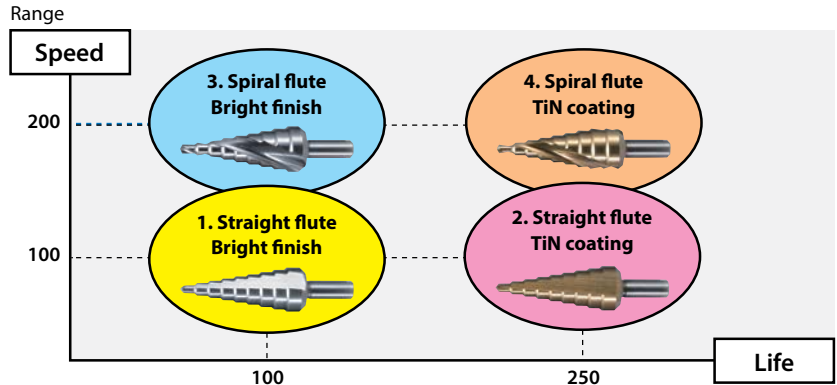

Material chart

AA : Recommended A : Acceptable

Description	Flute	Surface	Shank	Material				
				Plastic	Non-ferrous metal*	Sheet steel	Alloy steel	Cast iron
<b>1</b>		Bright finish	Straight (Three flat)	AA	AA	AA	A	A
<b>2</b>		Titanium coating		AA	AA	AA	A	A
<b>3</b>		Bright finish	1/4"Hex (E form)	AA	AA	AA	A	A
<b>4</b>		Titanium coating		AA	AA	AA	A	A

\*Non-ferrous metal (Such as Copper, Nickel and Zinc)

## Countersink bit



Material chart

AA : Recommended A : Acceptable

Description	Made of	Type	Shank	Material					
				Wood	Plastic	Non-ferrous metal*	Cast iron	Alloy steel	Stainless steel
7cutting edge	Alloy steel	Shallow sinking Suitable for flat countersinking.	1/4"Hex (E form)	AA	AA	AA	AA		
5cutting edge			Straight shank (Three flat)	AA	AA	AA	AA	AA	
3cutting edge	High speed steel	Deep sinking Suitable for deep countersinking.	1/4"Hex (C-form)	AA	AA	AA	AA	AA	
3cutting edge			Straight shank (Three flat)	AA	AA	AA	AA	AA	
Slanting hole It's for higher heat and abrasion resistance. Suitable for drilling tough metal.	High speed steel (Cobalt content 5%)	Shallow sinking Suitable for flat countersinking. Especially in thin metal sheets.	Straight shank (Three flat)		AA	AA	AA	AA	A

\*Non-ferrous metal (Such as Copper, Nickel and Zinc)

# Drilling (Wood / Metal)

## Cone drill bit



Shank type	Diameter (mm)	Length (mm)	Sales Pkg Qty	Part No.
Straight	3 to 14	58	1	D-40048
	4 to 20	71	1	D-40054
	16 to 30.5	76	1	D-40060
	24 to 40	58	1	D-40076



## Step drill bit straight flute



Shank type	Diameter (mm)	Length (mm)	Sales Pkg Qty	Part No.
1/4inch Hex MZ	4 to 12	65	1	D-40082
	4 to 20	75	1	D-40098
Straight	4 to 32	102	1	D-40107

## Step drill bit straight flute titanium coating



Shank type	Diameter (mm)	Length (mm)	Sales Pkg Qty	Part No.
1/4inch Hex MZ	4 to 12	65	1	D-40113
Straight	4 to 32	102	1	D-40135

## Step drill bit spiral flute



Shank type	Diameter (mm)	Length (mm)	Sales Pkg Qty	Part No.
1/4inch Hex MZ	4 to 12	65	1	D-40141
	4 to 20	75	1	D-40157
Straight	4 to 32	102	1	D-40163

## Step drill bit spiral flute titanium coating



Shank type	Diameter (mm)	Length (mm)	Sales Pkg Qty	Part No.
1/4inch Hex MZ	4 to 12	65	1	D-40179
	4 to 20	75	1	D-40185
Straight	4 to 32	102	1	D-40191



# Drilling (Wood / Metal)

## Countersink bit with three 90° cutting edges



Shank type	Diameter (mm)	Length (mm)	Sales Pkg Qty	Part No.
1/4inch Hex C-form	6.3	31	1	D-37312
	8.3	31	1	D-37328
	10.4	34	1	D-37334
	12.4	35	1	D-37340
	16.5	40	1	D-37356
	20.5	41	1	D-37362
Straight	6.3	45	1	D-37437
	8.3	50	1	D-37443
	10.4	50	1	D-37459
	12.4	56	1	D-37465
	16.5	60	1	D-37471
	20.5	63	1	D-37487
25	67	1	D-37493	

## Countersink bit with five 90° cutting edges



Shank type	Diameter (mm)	Length (mm)	Sales Pkg Qty	Part No.
Straight	6	48	1	D-37378
	8	48	1	D-37384
	10	40	1	D-37390
	12	40	1	D-37409
	16	43	1	D-37415
	20	45	1	D-37421

## Countersink bit with seven 90° cutting edges



Shank type	Diameter (mm)	Length (mm)	Sales Pkg Qty	Part No.
Straight	13	50	1	D-37306

## Slanting hole countersink bit



Shank type	Diameter (mm)	Length (mm)	Sales Pkg Qty	Part No.
Straight	2 to 5	45	1	D-37502
	5 to 10	48	1	D-37518
	10 to 15	65	1	D-37524
	15 to 20	85	1	D-37530



# Drilling (Wood / Metal)

## Broach Cutter For Magnetic Drilling Machine



Short = 25mm Depth	
Diameter	Part No.
12mm Short	(MM)12S
13mm Short	(MM)13S
14mm Short	(MM)14S
15mm Short	(MM)15S
16mm Short	(MM)16S
17mm Short	(MM)17S
18mm Short	(MM)18S
19mm Short	(MM)19S
20mm Short	(MM)20S
21mm Short	(MM)21S
22mm Short	(MM)22S
23mm Short	(MM)23S
24mm Short	(MM)24S
25mm Short	(MM)25S
26mm Short	(MM)26S
27mm Short	(MM)27S
28mm Short	(MM)28S
29mm Short	(MM)29S
30mm Short	(MM)30S
31mm Short	(MM)31S
32mm Short	(MM)32S
33mm Short	(MM)33S
34mm Short	(MM)34S
35mm Short	(MM)35S
36mm Short	(MM)36S
37mm Short	(MM)37S
38mm Short	(MM)38S
39mm Short	(MM)39S
40mm Short	(MM)40S
41mm Short	(MM)41S
42mm Short	(MM)42S
43mm Short	(MM)43S
44mm Short	(MM)44S
45mm Short	(MM)45S
46mm Short	(MM)46S
47mm Short	(MM)47S
48mm Short	(MM)48S
49mm Short	(MM)49S
50mm Short	(MM)50S

Long = 50mm Depth	
Diameter	Part No.
12mm Long	(MM)12L
13mm Long	(MM)13L
14mm Long	(MM)14L
15mm Long	(MM)15L
16mm Long	(MM)16L
17mm Long	(MM)17L
18mm Long	(MM)18L
19mm Long	(MM)19L
20mm Long	(MM)20L
21mm Long	(MM)21L
22mm Long	(MM)22L
23mm Long	(MM)23L
24mm Long	(MM)24L
25mm Long	(MM)25L
26mm Long	(MM)26L
27mm Long	(MM)27L
28mm Long	(MM)28L
29mm Long	(MM)29L
30mm Long	(MM)30L
31mm Long	(MM)31L
32mm Long	(MM)32L
33mm Long	(MM)33L
34mm Long	(MM)34L
35mm Long	(MM)35L
36mm Long	(MM)36L
37mm Long	(MM)37L
38mm Long	(MM)38L
39mm Long	(MM)39L
40mm Long	(MM)40L
41mm Long	(MM)41L
42mm Long	(MM)42L
43mm Long	(MM)43L
44mm Long	(MM)44L
45mm Long	(MM)45L
46mm Long	(MM)46L
47mm Long	(MM)47L
48mm Long	(MM)48L
49mm Long	(MM)49L
50mm Long	(MM)50L

## Broach Cutter Pilot Pin



Pilot pin	Part No.
25mm	(MM)PILOT S
50mm	(MM)PILOT L

## Chuck Adapter

For use with	Part No.
<b>A:</b> Chuck Adaptor	MMCHU03
<b>B:</b> 1/2" Chuck Adaptor For HB500	MMCHU05
<b>C:</b> Arbor (Minibor)	20358



# Drilling (Wood / Metal)

## Wood drill bit series

AA : Recommended    A : Acceptable

Category		Flat bit		Brad point drill bit			Single spur auger bit			Ship auger bit	
											
Description		Suitable for drilling holes with medium to large diameters in soft wood or soft plastic. It's simple made and reasonable price. It's popular especially in America.	Fast drilling bit with making-off blades and rake blades	This is the most popular drill in wood drill and suitable for drilling holes with small to medium diameter. Able to drill soft plastics other than general wood. Highly effective for drilling cleaner and more precise holes than flat bit.			Suitable for drilling of deep holes with medium to large diameters holes in soft and hard wood. Threaded screw point pull the bit into the work piece providing a fast, easy to use self feeding action. Highly effective for drilling cleaner and more precise holes than flat bit or wood drill bit.			Features of this item are fast drilling speed and good work amount per 1 charge.	Suitable for knotty nail embedded wood which unable to drill with single spur auger bit. Suitable for plumbing and electrical installation, etc.
Information	Shank	Straight (Hex) 	1/4"Hex (E-form) 	Straight (Cylindrical) 	1/4"Hex (E-form) 	SDS-PLUS 	Straight (Hex) 	1/4"Hex (E-form) 	Straight (Hex) 	5/16" & 7/16"Hex 	
	Diameter	6 - 36mm		3 - 20mm	2 - 15mm	4 - 10mm	6 - 30mm	6-21mm	6 - 30mm	10-38mm	
	Point	Brad point 		Brad point 			Auger thread 			Auger thread 	
Material	Wood 	AA		AA			AA			A	
	Wood with nail 									AA	
	Plywood 			A			A			A	
Processing	Thickness 										
	Blind hole 			A							
Action photo											



AA : Recommended      A : Acceptable

Category		Formwork drill bit	Self feeding bit	Forstner drill bit	T.C.T. Hinge cutting bit	Adjustable circle cutter
Description		Rarely being clogged even drilling on plywood including adhesive because of chisel edge.Can be used on formboard or 2x4 timbers at once because of their long overall length (400 & 600mm)	Suitable for drilling large diameter holes for pipe and conduit in wood.Threaded screw point pull the bit into the work piece providing a fast, easy to use self feeding action. Suitable for plumbing and electrical installation, etc	Suitable for drilling of blind holes or penetrating holes of medium to large diameter with highly. Can drill cleaner and more precise holes than T.C.T. Hinge drill bit. Suitable for precise working like a making furniture.	Suitable for drilling of blind holes or penetrating holes of medium or large diameter.Suitable for drilling holes in fancy plywood because making-off blade and rake blade are made T.C.T. tip.	Adjustable drilling diameter and able to work on plaster board mainly. Suitable for plumbing and installation of the downlight.
Information	Shank	Straight (Cylindrical) 	7/16"Hex 	Straight (Cylindrical) 	Straight (Cylindrical) 	Straight (Three flat) 
	Diameter	8-30mm	25-117mm	10-50mm	15-35mm	30-200mm
	Point	Chisel edge 	Auger thread 	Brad point (Short) 	Brad point (Short) 	Chisel edge 
Material	Wood 	A	AA	AA	AA	A
	Wood with nail 	A				
	Plywood 	AA			A	A
Processing	Thickness 					
	Blind hole 			AA	AA	
Action photo						



# Drilling (Wood / Metal)

## Wood Flat Bit



Diameter (mm)	Length (mm)	Sales Pkg Qty	Part No.
15	150	1	D-07727
25	150	1	D-07783
28	160	1	D-07808
30	160	1	D-07814

## Wood brad point drill bit



Diameter (mm)	Length (mm)	Working Length (mm)	Sales Pkg Qty	Part No.
3	60	33	1	D-07026
4	75	43	1	D-07032
5	85	52	1	D-07048
6	95	57	1	D-07054
6	315	150	1	D-07157
7	110	69	1	D-07060
8	115	75	1	D-07076
8	315	150	1	D-07163
9	125	80	1	D-07082
10	135	87	1	D-07098
10	315	150	1	D-07179
12	155	96	1	D-07107
12	315	150	1	D-07185
14	170	100	1	D-07113
14	315	150	1	D-07191
16	40	150	1	D-07200
16	180	100	1	D-07129
18	335	150	1	D-07216
20	250	130	1	D-07141
20	335	150	1	D-07222

## Wood single spur auger bit with Hex shank



Diameter (mm)	Length (mm)	Working Length (mm)	Sales Pkg Qty	Part No .
10	200	130	1	D-07250
12	200	130	1	D-07266
12	250	180	1	D-07369
14	200	130	1	D-07272
16	200	130	1	D-07288
16	250	180	1	D-07381
18	200	130	1	D-07294
18	250	180	1	D-07397
20	250	180	1	D-07406
20	450	380	1	D-07618
22	200	130	1	D-07319
24	200	130	1	D-07325
24	450	380	1	D-07630
26	450	380	1	D-07646
28	450	380	1	D-07652



# Drilling (Wood / Metal)

## Wood brad point drill bit with 1/4" Hex shank



Type NZ

Diameter (mm)	Length (mm)	Working Length (mm)	Sales Pkg Qty	Part No.
4	92	50	1	D-31251
6	110	65	1	D-31273
8	117	75	1	D-31289
10	133	87	1	D-31295

## Wood single spur auger bit with 1/4" Hex shank



Type NZ

Diameter (mm)	Length (mm)	Working Length (mm)	Sales Pkg Qty	Part No.
8	200	130	1	D-31332
10	200	130	1	D-31348
12	200	130	1	D-31354
16	200	130	1	D-31376
18	200	130	1	D-31382
20	200	130	1	D-31398
21	200	130	1	D-31407

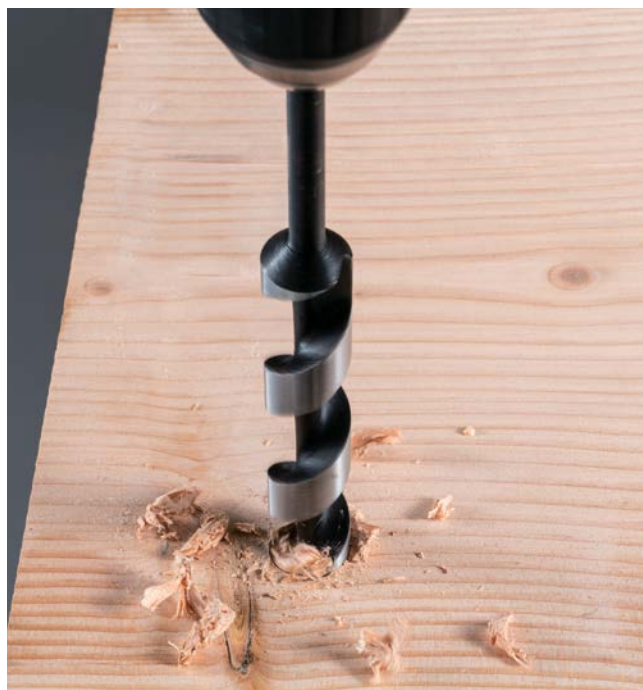

## Wood ship auger bit with 7/16" Hex shank

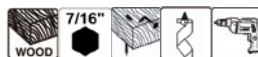

Diameter (mm)	Length (mm)	Working Length (mm)	Sales Pkg Qty	Part No.
10	165	100	1	D-36055
12	165	100	1	D-36061
14	165	100	1	D-36077
16	60	100	1	D-36083
18	165	100	1	D-36099
20	165	100	1	D-36108
22	165	100	1	D-36114
24	165	100	1	D-36120
26	165	100	1	D-36136
28	165	100	1	D-36142
30	165	100	1	D-36158
32	165	100	1	D-36164
35	165	100	1	D-36170
38	165	100	1	D-36186

## Wood Formwork drill bit



Diameter (mm)	Length (mm)	Working Length (mm)	Sales Pkg Qty	Part No.
8	400	75	1	D-70219
8	600	75	1	D-70334
10	400	87	1	D-70225
10	600	87	1	D-70340
12	400	101	1	D-70231
12	600	101	1	D-70356
14	400	108	1	D-70247
14	600	108	1	D-70362
16	400	100	1	D-70253
16	600	100	1	D-70378
18	400	100	1	D-70269
18	600	100	1	D-70384
20	400	100	1	D-70275
20	600	100	1	D-70390
22	400	100	1	D-70281
22	600	100	1	D-70409
24	400	100	1	D-70297
24	600	100	1	D-70415
26	400	100	1	D-70306
26	600	100	1	D-70421
28	400	100	1	D-70312
28	600	100	1	D-70437
30	400	100	1	D-70328
30	600	100	1	D-70443

# Drilling (Wood / Metal)

## Wood brad point drill bit for SDS-PLUS Hammers



Diameter (mm)	Length (mm)	Working Length (mm)	Sales Pkg Qty	Part No.
4	105	43	1	B-57489
5	116	52	1	B-57495
6	123	57	1	B-57504
8	147	75	1	B-57510
10	163	87	1	B-57526

## Wood TCT Hinge cutting bit



Diameter (mm)	Length (mm)	Sales Pkg Qty	Part No.
15	77	1	D-71093
19	77	1	D-71102
20	77	1	D-71118
25	77	1	D-71124
26	77	1	D-71130
30	77	1	D-71146
32	77	1	D-71152
35	77	1	D-71168

## Earth auger drill bit with 3/4" SQ shank



Diameter (mm)	Length (mm)	Working Length (mm)	Sales Pkg Qty	Part No.
20	600	530	1	B-54302
25			1	B-54318
30			1	B-54324
35			1	B-54330
40			1	B-57576

## Earth auger drill bit for Driver Drill



Diameter (mm)	Length (mm)	Working Length (mm)	Sales Pkg Qty	Part No.
30	600	200	1	D-75415
45			1	D-75421
70			1	D-75437

## Drill bit set for SDS-PLUS Hammers

Replace commonly used hammer drill in ordinary families with this compact and handy rotary hammer



Diameter (mm)	Sales Pkg Qty	Part No.
Metal 3,4 Wood 4,5,6	5	B-57532

## Drill bit 5pcs set with 1/4" Hex shank



Diameter (mm)	Sales Pkg Qty	Part No.
Masonry 6 Metal 5, 6 Wood 5, 6	5	D-31522



# Drilling (Wood / Metal)

## Holesaw

### BiM holesaw

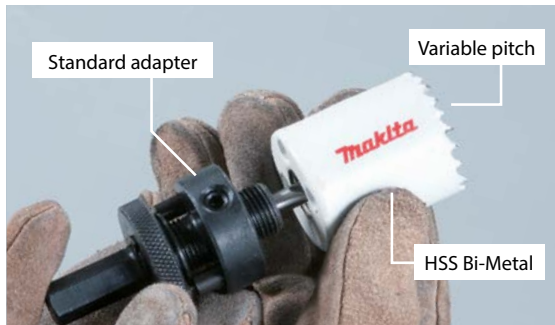

### TCT holesaw

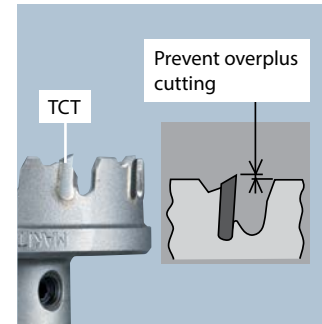

### Diamond wet holesaw

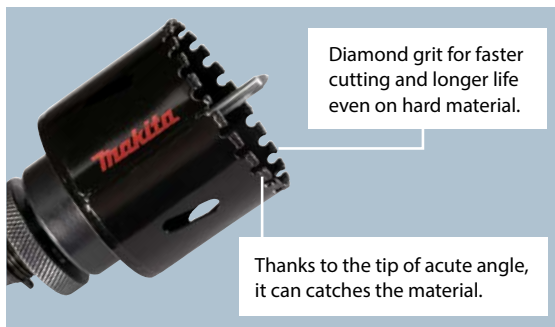



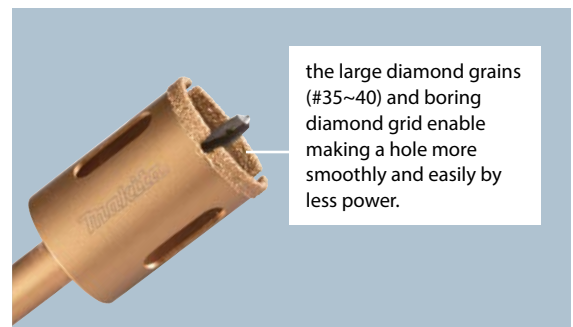



### Vacuum brazed diamond holesaw



## Material Chart

AA : Recommended

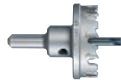
A : Acceptable

Application	Steel	Inox Stainless	Aluminum	Non ferrous Metal	Wood	MDF	PLASTER BOARD	PVC	FRP	SOFT TILE	Brick	Lime stone	Marble
	METAL	STAINLESS INOX INROSTA	ALU	Cu CS Ni Me Zn	WOOD			PVC	FIBREGLASS				
BiM 	AA		A	A	AA			AA					
BiM for sheet metal 	AA	AA	A	A									
Vacuum brazed diamond 										AA	AA	AA	AA
Diamond wet holesaw 										AA			AA
TCT 	AA	AA	A	A				AA	AA				
TC grit 										AA	AA		

# Drilling (Wood / Metal)

## BiM Hole saw

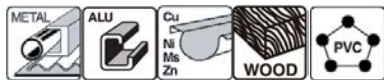

Size (mm)	Working Length (mm)	Part No.
14	38	D-35368
16	38	D-16994
17	38	D-35374
19	38	D-17005
20	38	D-17251
21	38	D-35380
22	38	D-17011
24	38	D-17027
25	38	D-17033
27	38	D-35396
29	38	D-17267
30	38	D-35405
32	38	D-17049
33	38	D-35411
35	38	D-17055
40	38	D-17273
41	38	D-35433
43	38	D-35449
44	38	D-17077
46	38	D-35455
51	38	D-17083
52	38	D-35477
54	38	D-24876
57	38	D-17099
60	38	D-25688
64	38	D-30140
65	38	D-24882
67	38	D-35508
68	38	D-17108
70	38	D-25694
73	38	D-35514
76	38	D-17114
79	38	D-35520
80	38	D-33869
83	38	D-17120
86	38	D-35536
89	38	D-35542
92	38	D-17136
95	38	D-35558
98	38	D-35564
102	38	D-35570
105	38	D-17142
108	38	D-35586
111	38	D-35592
114	38	D-35601
121	38	D-35617
127	38	D-17158
152	38	D-17164

## or Ezychange BiM Holesaw

Pilot drill



Adapter



Application	Fits Holesaw	Sales pkg q'ty	Part No.
-------------	--------------	----------------	----------

Adapter with pilot drill

For 10mm drill	14 - 29mm	1	D-17170
For 13mm drill	32 - 152mm	1	D-17186
For SDS-PLUS Hammer	14 - 29mm	1	D-17603
For SDS-PLUS Hammer	32 - 76mm	1	D-17619

Pilot drill

Length 71mm	All	1	D-17192
-------------	-----	---	---------

## BiM holesaw assortment

Most six common sizes for Plumber & Electrician.

A: 11mm (\*7/16")  
Adapter with pilot drill

B: 9.5mm (\*3/8")  
Adapter with pilot drill

C: Ejector spring



Suitable for	Included holesaws (1 each)	Part No.
For Plumber	19,22,29,38,44,57mm,adapter A, adapter B, ejector spring	D-47117
For Electrician	16,20,25,32,40,51mm,adapter A, adapter B, ejector spring	D-47123
For Electrician	20,25,32,40,51,65mm,adapter A, adapter B, ejector spring	D-47139

# Drilling (Wood / Metal)

## BiM holesaw for sheet metal



Size (mm)	Working Length (mm)	Part No.	Size (mm)	Working Length (mm)	Part No.
16	20	B-29670	60	20	B-29882
19	20	B-29692	64	20	B-29898
20	20	B-29701	65	20	B-35994
22	20	B-29723	68	20	B-36011
25	20	B-29739	70	20	B-36027
29	20	B-29751	76	20	B-36049
32	20	B-29773	83	20	B-36061
35	20	B-29795	89	20	B-36083
38	20	B-29804	102	20	B-36099
40	20	B-29810	127	20	B-36108
51	20	B-29854	152	20	B-36114

Adapter with HSS pilot drill



Pilot drill



Application	Fits Holesaw	Part No.
-------------	--------------	----------

Adapter with pilot drill

For 10mm drill	16 - 35mm	B-36120
For 13mm drill	38 - 152mm	B-36136

Pilot drill

Length 60mm	All	B-36142
-------------	-----	---------

## TC grit holesaw



Size (mm)	Working Length (mm)	Part No.
33mm (1-5/16")	64	D-51188
43mm (1-11/16")	64	D-51194
53mm (2-3/32")	64	D-51203
63mm (2-1/2")	64	D-51219
67mm (2-5/8")	64	D-51225
73mm (2-7/8")	64	D-51231
83mm (3-1/4")	64	D-51247

Adapter with TCT pilot drill



TCT pilot drill



Application	Fits hole saws	Part No.
-------------	----------------	----------

Adapter with Pilot Drill	All	D-51253
Pilot drill	All	D-51269

# Drilling (Wood / Metal)

## Vacuum brazed diamond holesaw



Size (mm)	Working Length (mm)	Part No.
16	40	B-45995
19	40	B-46006
25	40	B-46012
30	40	B-46028
32	40	B-46034
35	40	B-46040
38	40	B-46056
45	40	B-46062
53	40	B-46084
57	40	B-46090
64	40	B-46109

Holesaw with shank and pilot drill



Size (mm)	Working Length (mm)	Part No.
16	40	B-45870
19	40	B-45886
25	40	B-45892
30	40	B-45901

Size (mm)	Working Length (mm)	Part No.
38	40	B-45939
50	40	B-45951

Shank with pilot drill



Shank



Pilot drill



Application	Type of pilot drill	Fits Holesaw	Part No.
-------------	---------------------	--------------	----------

Shank with pilot drill

For 13mm drill	TCT	All	B-46115
----------------	-----	-----	---------

Pilot drill

For 13mm drill	TCT	All	B-46121
----------------	-----	-----	---------



# ACCESSORIES

## ▣ Drilling (Masonry)



Metal, mild steel



Aluminum



Wood



Tile



Concrete



Reinforced concrete



Brick



Stone



Asphalt



Plastic



Mine



2cutter



4cutter



Centering tip



Self sharpening



Full carbide head



Dustless



# Drilling (Masonry)

## T.C.T drill bit with Straight shank/ Brick



Bit Dia (mm)	Length (mm)	Working Length (mm)	Sales Pkg Qty	Part No.
3.5	75	40	1	D-40733
4.5	85	55	1	D-40755
5	85	55	1	D-40761
5.5	150	100	1	D-40799
6	400	350	1	D-40836
6.5	100	60	1	D-40842
6.5	150	100	1	D-40858
6.5	400	350	1	D-40864
7	400	350	1	D-40892
8	400	350	1	D-40939
10	150	100	1	D-40967
10	200	130	1	D-40973
10	400	350	1	D-40989
12	200	130	1	D-41012
12	400	350	1	D-41028

## T.C.T drill bit set with Straight shank/ Brick



Bit Dia (mm)	Length (mm)	Working Length (mm)	Part No.
5	85	55	D-41034
6	100	60	
8	120	80	

## TCT drill bit with Straight shank / Multi material 5pcs. assortment



\* 5 different sizes

Bit Dia (mm)	Length (mm)	Part No.
4	75	E-14255
5	85	
6	100	
8	120	
10	150	

## T.C.T drill bit with Straight shank/ Two-star



Bit Dia (mm)	Length (mm)	Working Length (mm)	Sales Pkg Qty	Part No.
3	60	30	1	D-05228
4	70	35	1	D-05234
5	85	45	1	D-05240
6	100	60	1	D-05256
6	150	90	1	D-05262
7	100	55	1	D-05278
7	150	90	1	D-05284
8	110	60	1	D-05290
8	150	90	1	D-05309
9	150	90	1	D-05315
10	150	90	1	D-05321
11	150	90	1	D-05337
12	150	90	1	D-05343
13	150	85	1	D-05359
16	150	85	1	D-05387

## T.C.T drill bit 5 pcs set with Straight shank/ Two-star



\* 5 different sizes

Bit Dia (mm)	Length (mm)	Working Length (mm)	Part No.
4	70	35	E-11536
5	85	45	
6	100	60	
8,10	110	60	D-20719
5, 6, 7, 8, 10	110	60	



# Drilling (Masonry)

## T.C.T drill bit with 1/4" Hex shank



Type NZ

Diameter (mm)	Length (mm)	Working Length (mm)	Sales Pkg Qty	Part No.
3	80	35	1	D-31463
4	80	35	1	D-31479
6	100	55	1	D-31491
8	100	55	1	D-31500

## Glass bit with straight shank



Diameter (mm)	Length (mm)	Sales Pkg Qty	Part No.
3	65	1	D-25111
4	65	1	D-25127
5	65	1	D-25133
6	65	1	D-25149
8	70	1	D-25155
10	80	1	D-25161
12	80	1	D-25177

## Glass bit with 1/4" Hex shank



1/4"Hex (NZ)

Diameter (mm)	Length (mm)	Sales Pkg Qty	Part No.
4	65	1	D-31413
5	65	1	D-31429
6	65	1	D-31435
8	70	1	D-31441
10	80	1	D-31457

## T.C.T drill bit with Straight shank/ Omnibohrer

Omnibohrer

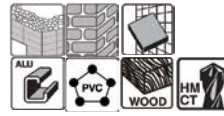

Bit Dia (mm)	Length (mm)	Working Length (mm)	Sales Pkg Qty	Part No.
3	60	28	1	D-30287
4	70	35	1	D-30293
5	85	43	1	D-30302
5.5	85	43	1	D-31027
5.5	100	58	1	D-31033
5.5	150	108	1	D-31049
6	100	58	1	D-30318
6	150	108	1	D-30324
6.5	85	43	1	D-31055
6.5	100	58	1	D-31061
6.5	150	108	1	D-31077
7	100	53	1	D-30330
7	150	108	1	D-30346
8	110	57	1	D-30352
8	150	97	1	D-30368
9	150	97	1	D-30374
10	150	97	1	D-30380
10	400	300	1	D-30396
11	150	91	1	D-30405
12	150	91	1	D-30411
12	400	298	1	D-30427
12	600	500	1	D-30433
13	150	85	1	D-30449
14	150	85	1	D-30455
14	400	300	1	D-30461

## T.C.T drill bit 5 pcs set with Straight shank/ Omnibohrer

Omnibohrer

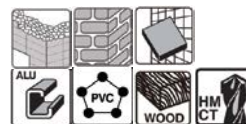













\* 5 different sizes

Bit Dia (mm)	Length (mm)	Working Length (mm)	Part No.
4	70	35	D-36712
5	85	43	
6	100	58	
8,10	150	97	D-30477
5	85	43	
6	100	58	
8	110	57	
10,12	150	97	

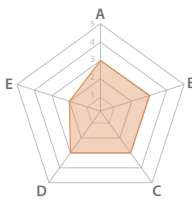
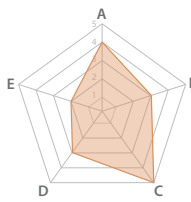
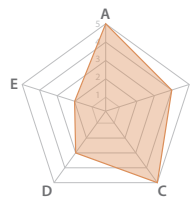
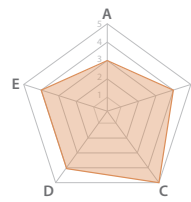
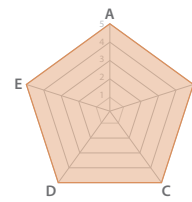
# Drilling (Masonry)

## T.C.T drill bit for SDS-PLUS Hammers













Product	Standard type	Centering Tip	Centering Tip V-PLUS	4 cutter	NEMESIS II
Range	★ ★	★ ★ ★	★ ★ ★ ★	★ ★ ★	★ ★ ★ ★ ★
Carbide					
Tip	2 Cutter	Centering tip 2 Cutter	Centering tip 2 Cutter	Centering tip 4 Cutter	*Full carbide tip 4 Cutter 
Flute	Standard 2 flute	Standard 2 flute	High Durability 2 flute	Standard 2 flute	High Durability 4 flute
Size	3.5 - 30mm 5/32" - 1"	4 - 32mm 5/32" - 1"	3.5-26mm	5 - 25mm	5 - 32mm 5/32" - 1-1/4"
Chart					
Work material					

\*Full carbide spec is only for dia. 5 to 16mm

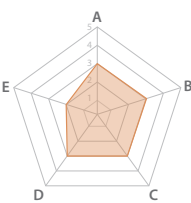
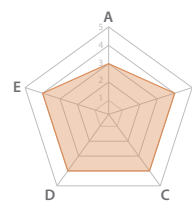
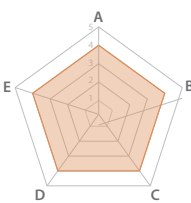
## T.C.T drill bit for SDS-MAX Hammers



Product	Standard type	4 cutter	NEMESIS	Mining
Range	★ ★	★ ★ ★	★ ★ ★ ★	Specialized
Carbide				
Tip	2 Cutter	Centering tip 4 cutter	Centering tip 4 Cutter 	4 Cutter 
Flute	Standard 2 flute	Standard 2 flute	High Durability 4 flute	High Durability 2 flute
Size	12-40mm 1/2" - 1-1/2"	12-30mm	12-40mm 1/2" - 1-1/2"	28-32mm
Chart				Specialized
Work material				

# Drilling (Masonry)

## T.C.T drill bit for SDS-PLUS hammers



Diameter (mm)	Length (mm)	Working Length (mm)	Sales Pkg Qty	Part No.
3.5	110	50	1	D-15665
4	110	50	1	D-00016
4	160	100	1	D-66612
5	110	50	1	D-00022
5	160	100	1	D-00038
5	210	150	1	D-66628
5.5	110	50	1	D-00044
5.5	160	100	1	D-16106
6	110	50	1	D-00050
6	160	100	1	D-00066
6	210	150	1	D-00072
6.5	110	50	1	D-00088
6.5	160	100	1	D-00094
6.5	210	150	1	D-45082
6.5	260	200	1	D-66634
7	110	50	1	D-00103
7	160	100	1	D-00119
8	110	50	1	D-00125
8	160	100	1	D-00131
8	210	150	1	D-00147
8	260	200	1	D-00153
8	310	250	1	D-66640
9	110	50	1	D-08040
9	160	100	1	D-08056
9	210	150	1	D-00169
10	110	50	1	D-09117
10	160	100	1	D-00175
10	210	150	1	D-00181
10	260	200	1	D-00197
10	310	250	1	D-00206
10	350	290	1	D-66656
10.5	160	100	1	D-01127
11	160	100	1	D-00212
11	210	150	1	D-66662
11	260	200	1	D-66678
12	160	100	1	D-00228
12	210	150	1	D-00234
12	260	200	1	D-00240
12	310	250	1	D-66684
12	350	290	1	D-16112
12	460	400	1	D-16271
12.5	160	100	1	D-14102
12.7	160	100	1	D-03280
13	160	100	1	D-00256
13	210	150	1	D-66690
13	260	200	1	D-25622

Diameter (mm)	Length (mm)	Working Length (mm)	Sales Pkg Qty	Part No.
13	350	290	1	D-16128
14	160	100	1	D-00262
14	210	150	1	D-21331
14	260	200	1	D-00278
14	310	250	1	D-66709
14	350	290	1	D-16134
14	460	400	1	D-17544
14.3	160	100	1	D-03997
15	160	100	1	D-00284
15	350	290	1	D-16140
16	160	100	1	D-03981
16	210	150	1	D-00290
16	260	200	1	D-16156
16	310	250	1	D-00309
16	350	290	1	D-16162
16	460	400	1	D-16287
17	160	100	1	D-16178
17	210	150	1	D-00315
17	350	290	1	D-16190
17.5	160	100	1	D-03305
18	160	100	1	D-16209
18	210	150	1	D-00321
18	260	200	1	D-16215
18	300	240	1	D-00337
18	350	290	1	D-16221
18	460	400	1	D-17566
19	210	150	1	D-00343
19	350	290	1	D-16243
20	210	150	1	D-00359
20	260	200	1	D-16259
20	310	250	1	D-00365
20	350	290	1	D-16265
20	460	400	1	D-15235
22	260	200	1	D-00371
22	310	250	1	D-08062
22	460	400	1	D-15241
24	460	400	1	D-16302
25	260	200	1	D-00387
25	310	250	1	D-08517
25	350	290	1	D-03311
25	460	400	1	D-15257
26	260	200	1	D-00393
26	310	250	1	D-08078
26	460	400	1	D-15263
28	460	400	1	D-16318

# Drilling (Masonry)

## T.C.T drill bit for SDS-PLUS hammers/ Dustless



Bit Dia (mm)	Length (mm)	Working Length (mm)	Sales Pkg Qty	Part No.
18	360	240	1	B-64412

## T.C.T drill bit for SDS-PLUS hammers/V-PLUS



**V-PLUS**



SDS-PLUS

Bit Dia (mm)	Length (mm)	Working Length (mm)	Sales Pkg Qty	Part No .
7	160	100	1	B-47444
8	210	150	1	B-47472
10	450	390	1	B-47606
12	450	400	1	B-47721
14	160	110	1	B-46589
14	450	400	1	B-47830
15	450	400	1	B-47896
16	450	400	1	B-47949
18	300	250	1	B-48016
18	450	400	1	B-48022
20	450	400	1	B-48094
25	450	400	1	B-48234
26	450	400	1	B-48278

V-PLUS

Bit Dia (mm)	Length (mm)	Sales Pkg Qty	Part No .
10	260	1	B-47575

## T.C.T drill bit for SDS-PLUS hammers/ Centering tip



Bit Dia (mm)	Length (mm)	Working Length (mm)	Sales Pkg Qty	Part No.
4	110	50	1	B-55859
5	110	50	1	B-54128
5.5	110	50	1	B-55865
6	160	100	1	B-54156
6.5	110	50	1	B-55887
6.5	160	100	1	B-55893
7	110	50	1	B-55924
8	110	50	1	B-54178
8	160	100	1	B-54184
8	210	150	1	B-55952
8	260	200	1	B-55968
9	160	100	1	B-55974
10	110	50	1	B-55980
10	160	100	1	B-54190
10	210	150	1	B-54209
10	260	200	1	B-55996
10	310	250	1	B-56007
12	160	100	1	B-54215
17	210	140	1	B-56465
18	210	150	1	B-62125
19	210	150	1	B-62147
22	210	150	1	B-62181
25	210	150	1	B-62228
25	350	290	1	B-62234

# Drilling (Masonry)

## T.C.T drill bit set for SDS-PLUS hammers

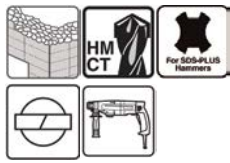

Bit Dia (mm)	Length (mm)	Working Length (mm)	Part No.
5, 6, 8	110	50	D-00795
6, 8	160	100	
5.5, 7	110	50	D-03888
6, 7, 8	160	100	
6, 6.5	110	50	D-17784
8, 10, 12	160	100	
5, 6, 7, 8, 10	160	100	D-20703

## T.C.T drill bit set for SDS-PLUS hammers/ Aluminum case



6pc. assortment

Description	Part No.
5, 6, 8 x160	D-58920
Bull Point 250	
Cold Chisel 20x250	
Scaling Chisel 40x250	

## T.C.T drill bit for SDS-PLUS hammers/ 4 cutter



Bit Dia (mm)	Length (mm)	Working Length (mm)	Sales Pkg Qty	Part No.
5	110	50	1	B-68127
5	160	100	1	B-68133
5	210	150	1	B-68149
5	260	200	1	B-68155
6	110	50	1	B-62496
6	160	100	1	B-62505
6	210	150	1	B-62511
6	260	200	1	B-62527
6	310	250	1	B-68161
6.5	110	50	1	B-62533
6.5	160	100	1	B-62549
6.5	210	150	1	B-62555
6.5	260	200	1	B-62561
7	110	50	1	B-62577
7	160	100	1	B-62583
7	210	150	1	B-62599
8	110	50	1	B-62608
8	160	100	1	B-62614
8	210	150	1	B-62620
8	260	200	1	B-62636
8	310	250	1	B-62642
8	460	400	1	B-62658
10	110	50	1	B-62664
10	160	100	1	B-62670
10	210	150	1	B-62686
10	260	200	1	B-62692
10	310	250	1	B-62701
10	350	290	1	B-62717
10	460	400	1	B-62723
12	160	100	1	B-62739
12	210	150	1	B-62745
12	260	200	1	B-62751
12	310	250	1	B-62767
12	350	290	1	B-62773
12	460	400	1	B-62789
14	160	100	1	B-62795
14	210	150	1	B-62804
14	260	200	1	B-62810
14	310	250	1	B-62826
14	350	290	1	B-62832
14	460	400	1	B-62848
16	210	150	1	B-62860
16	260	200	1	B-62876
16	310	250	1	B-62882
16	350	290	1	B-62898
16	460	400	1	B-62907
18	260	200	1	B-68177
18	460	400	1	B-68236
20	260	200	1	B-68183
20	460	400	1	B-68242
22	260	200	1	B-68199
22	460	400	1	B-68258
25	260	200	1	B-68208
25	460	400	1	B-68264

# NEMESIS II



	Hole	Tungsten carbide tip

The drilling hole is closer to a circle than 2cutter.  
Lifetime is longer than 2cutter because of big TCT.

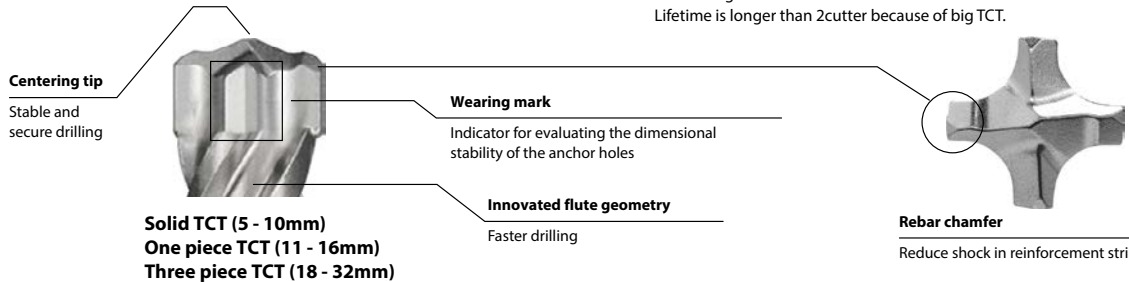

**Solid TCT (5 - 10mm)**  
**One piece TCT (11 - 16mm)**  
**Three piece TCT (18 - 32mm)**

## T.C.T drill bit for SDS-PLUS hammers/ Nemesis II



Bit Dia (mm)	Length (mm)	Working Length (mm)	1pc.	5pcs.	10pcs.
			Part No.	Part No.	Part No.
5	115	50	B-57897	B-58796	B-63214
5	165	100	B-57906	-	B-63220
5.5	115	50	B-57940	B-58805	B-63236
5.5	165	100	B-57956	-	B-63242
6	115	50	B-57962	B-58811	-
6	165	100	B-57978	-	B-63264
6	215	150	B-57984	-	-
6	265	200	B-57990	-	-
6	315	250	B-58001	-	-
6.5	165	100	B-58023	-	B-63301
6.5	215	150	B-58039	-	-
6.5	265	200	B-58045	-	-
6.5	315	250	B-58051	-	-
7	115	50	B-58067	-	-
7	165	100	B-58073	-	-
8	115	50	B-58095	B-58883	-
8	165	100	B-58104	B-58899	B-63373
8	215	150	B-58110	-	-
8	265	200	B-58126	-	-
8	315	250	B-58132	-	-
9	165	100	B-58176	-	-
10	115	50	B-58198	-	-
10	165	100	B-58207	B-58914	B-63410
10	215	150	B-58213	B-58920	B-63426
10	265	200	B-58229	-	-
10	315	250	B-58235	-	-
10	455	390	B-58257	-	-
10	600	540	B-58263	-	-
10	1000	940	B-58279	-	-

Bit Dia (mm)	Length (mm)	Working Length (mm)	1pc.	5pcs.	10pcs.
			Part No.	Part No.	Part No.
12	160	110	E-14532	B-58936	E-14825
12	210	160	E-14548	E-14803	B-63460
12	260	210	B-58344	-	-
12	310	260	B-58350	-	-
12	450	400	B-58366	-	-
12	600	550	B-58372	-	-
12	1000	950	B-58388	-	-
14	160	110	B-58431	-	-
14	210	160	E-14635	-	-
14	260	210	E-14641	-	-
14	310	260	B-58453	-	-
14	450	400	B-58469	-	-
14	600	550	B-58475	-	-
14	1000	950	B-58481	-	-
15	160	110	E-19607	-	-
15	210	160	E-14691	-	-
15	260	210	B-58512	-	-
15	450	400	B-58528	-	-
15	600	550	B-58534	-	-
16	160	110	B-58540	-	-
16	210	160	B-58544	-	-
16	260	210	E-14744	-	-
16	310	260	B-58562	-	-
16	450	400	B-58578	-	-
16	600	550	E-14772	-	-
16	1000	950	B-58590	-	-
16	1000	950	B-58609	-	-
18	250	200	B-58615	-	-
18	450	400	B-58621	-	-
20	250	200	B-58637	-	-
20	450	400	B-58659	-	-
22	250	200	B-58665	-	-
22	450	400	B-58687	-	-
24	250	200	B-58693	-	-
24	450	400	B-58702	-	-
25	250	200	B-58718	-	-
25	450	400	B-58724	-	-
28	450	400	B-58752	-	-
30	450	400	B-58774	-	-
32	450	400	B-58780	-	-

# Drilling (Masonry)

## Nemesis II SDS-Plus Hammer Assortment Set



Bit Dia (mm)	Length (mm)	Working Length (mm)	Part No.
5,6	110	60	B-58992
6,8,10	160	110	

## HSS-TiN impact drill bit for SDS-PLUS Hammers



Two- star range



Type NZ

Diameter (mm)	Length (mm)	Working Length (mm)	Sales Pkg Qty	Part No.
3	90	33	1	B-57401
3.5	100	39	1	B-57417
4	105	43	1	B-57423
4.5	110	47	1	B-57439
5	116	52	1	B-57445
5.5	123	57	1	B-57451
6	12	57	1	B-57467
6.5	131	63	1	B-57473

## Wood drill bit for SDS-PLUS Hammers



Diameter (mm)	Length (mm)	Working Length (mm)	Sales Pkg Qty	Part No.
4	105	43	1	B-57489
5	116	52	1	B-57495
6	123	57	1	B-57504
8	147	75	1	B-57510
10	163	87	1	B-57526

## SDS-PLUS Sleeve chuck bit holder



Size (mm)	Sales Pkg Qty	Part No.
80	1	B-57548

## T.C.T drill bit for SDS-MAX hammers/ Nemesis



Bit Dia (mm)	Length (mm)	Working Length (mm)	Sales Pkg Qty	Part No.
16	340	200	1	B-19962
16	540	400	1	B-19978
18	340	200	1	B-19990
18	540	400	1	B-20002
20	320	200	1	B-20024
20	520	400	1	B-20030
22	520	400	1	B-20068
25	520	400	1	B-20111
25	920	800	1	B-20127
28	370	250	1	B-20149
28	570	450	1	B-20155
30	570	450	1	B-20199
32	570	450	1	B-20214
35	570	450	1	B-20242
40	570	450	1	B-20301

## T.C.T drill bit for SDS-MAX hammers



Bit Dia (mm)	Length (mm)	Working Length (mm)	Sales Pkg Qty	Part No.
12	340	200	1	D-33875
14	340	200	1	D-33897
14	540	400	1	D-33906
15	340	200	1	D-33912
16	340	200	1	D-33934
16	540	400	1	D-33940
18	340	200	1	D-33956
18	540	400	1	D-33962
20	540	400	1	D-33984
20	340	200	1	D-33978
22	340	200	1	D-33990
22	540	400	1	D-34001
24	340	200	1	D-34017
24	540	400	1	D-34023
25	340	200	1	D-34039
25	540	400	1	D-34045
28	370	250	1	D-34051
28	570	450	1	D-34067
30	370	250	1	D-34073
30	570	450	1	D-34089
32	370	250	1	D-34095
32	570	450	1	D-34104
35	370	250	1	D-34110
35	570	450	1	D-34126
38	370	250	1	D-34132
38	570	450	1	D-34148
40	370	250	1	D-34154
40	570	450	1	D-34160



# Drilling (Masonry)

## Concrete core cutter for SDS-MAX hammers



Bit Dia (mm)	Length (mm)	Sales Pkg Qty	Part No.
40	550	1	B-57629
45	550	1	B-57635
45	990	1	B-57641
55	550	1	B-57657
55	990	1	B-57663
65	550	1	B-57679
65	990	1	B-57685
80	550	1	B-57691
80	990	1	B-57700

## T.C.T drill bit for SDS-MAX hammers/ Mining



Bit Dia (mm)	Length (mm)	Working Length (mm)	Sales Pkg Qty	Part No.
32	920	800	1	B-15045

## T.C.T drill bit for 17mm Hex shank hammers











Bit Dia (mm)	Length (mm)	Sales Pkg Qty	Part No.
16	280	1	D-20127
16	505	1	D-20133
18	280	1	D-20149
18	505	1	D-20155
19	280	1	D-20161
19	505	1	D-20177
20	280	1	D-20183
20	505	1	D-20199
22	280	1	D-20208
22	505	1	D-20214
25.5	280	1	D-20220
25.5	505	1	D-20236
28	280	1	D-20242
28	505	1	D-20258
32	505	1	D-20270
35	505	1	D-20292



# Drilling (Masonry)

## Chisels

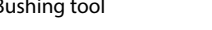

Shape	Application	For SDS-PLUS Hammers	For SDS-MAX Hammers	17mm Hex	19mm Hex	21mm Hex	28.6mm Hex	30mm Hex	Makita Small
<b>Bull point</b> 	Demolition and adjustment work in masonry and concrete. Chipping and breaking in masonry and concrete. Starts holes in concrete.	●	●	●	●	●	●	●	●
<b>Cold chisel</b> 	Adjustment work in masonry and concrete. Chipping, breaking, edging and channeling in masonry and concrete.	●	●	●	●	●	●	●	
<b>Grooving chisel</b> 	Cutting channels in concrete.	●	●	●					
<b>Scaling chisel</b> 	Removing concrete residues.	●	●	●	●	●	●	●	●
<b>Clay spade</b> 	Digging in clay, hard gravel, hard packed gravel, soil and dirt.		●	●		●		●	
<b>Rammer</b> 	Tamping asphalt and compacting gravel, soil and dirt.		●	●	●	●		●	
<b>Bushing tool</b> 	Roughing concrete and asphalt up.		●	●		●			
<b>Scraper</b> 	Scraping floor tiles, linoleum floor and clean-up.	●							●

# Drilling (Masonry)

## Bull point for SDS-PLUS hammers



Length (mm)	Sales Pkg Qty	Part No.
160	1	D-08034
250	1	D-08713

## Bull point for SDS-PLUS hammers/ Premium



Length (mm)	Sales Pkg Qty	Part No.
250	1	B-64238

## Cold chisel for SDS-PLUS hammers



Size (mm)	Sales Pkg Qty	Part No.
20 x 160	1	D-71255
20 x 230	1	D-71261
20 x 250	1	D-08729
20 x 400	1	D-19021

## Cold chisel for SDS-PLUS hammers/ Premium



Size (mm)	Sales Pkg Qty	Part No.
20 x 250	1	B-64244

## Scaling chisel for SDS-PLUS hammers



Size (mm)	Sales Pkg Qty	Part No.
40 x 250	1	D-08735
50 x 215	1	D-25616

## Scaling chisel for SDS-PLUS hammers/ Premium



Size (mm)	Sales Pkg Qty	Part No.
40 x 250	1	B-64250

## Scraper Assembly for SDS-PLUS hammers



Length(mm)	Type	Part No.
100 x 160	-	A-68161
100	Cutter	343411-9

## Chisel set for SDS-PLUS hammers



Description	Part No.
Bull Point 230	D-71314
Cold Chisel 20 x 230	
Scaling Chisel 40 x 230	

# Drilling (Masonry)

## Chisel set for SDS-PLUS hammers/ Aluminum case



3pc. assortment

Description	Part No.
Bull Point 250	D-05181
Cold Chisel 20 x 250	
Scaling Chisel 40 x 250	

4pc. assortment

Description	Part No.
Bull Point 250	D-08757
Cold Chisel 20 x 250	

5pc. assortment

Description	Part No.
Bull Point 250	D-16368
Cold Chisel 20 x 250	
Scaling Chisel 40 x 250	

## T.C.T drill bit & chisel set for SDS-PLUS hammers/ Aluminum case in Makita blue



10pc. assortment

Description	Part No.
5x160, 6x160, 8x160, 10x160, 12x160, 10x210, 12x210, 16x210	D-71990
Bull Point 250	
Cold Chisel 20x250	

18pc. assortment

Description	Part No.
5 x 110, 6 x 110, 8 x 110, 10 x 110, 6 x 160, 8 x 160, 10 x 160, 12 x 160, 8 x 210, 10 x 210, 10 x 260, 12 x 260	D-71180
Bull Point 140, 250	
Cold Chisel 20x140, 20x250	
Scaling Chisel 40x250	
Drill Chuck & Chuck Key 13mm	

## Self sharpening bull point



### Feature

Unique star-shape design keeps always sharp

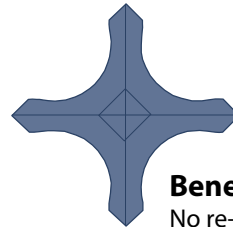
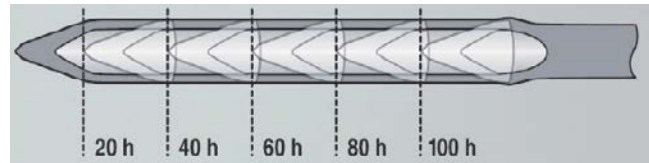

### Benefit

No re-sharpening necessary  
No work interruption due to resharpening  
No service costs

## Bull point for SDS-MAX hammers/ Self-sharpening

*Self sharpening*



Length (mm)	Sales Pkg Qty	Part No.
400	1	E-13172

## Cold chisel for SDS-MAX hammers/ Premium



Size (mm)	Sales Pkg Qty	Part No.
25 x 400	1	B-64272

## Bull point for SDS-MAX hammers/ Premium



Length (mm)	Sales Pkg Qty	Part No.
400	1	B-64266

# Drilling (Masonry)

## Bull point for SDS-MAX hammers



Length (mm)	Sales Pkg Qty	Part No.
280	1	A-80787
300	1	D-34176
400	1	A-80793
400	1	D-34182
600	1	D-34198

## Cold chisel for SDS-MAX hammers



Size (mm)	Sales Pkg Qty	Part No.
25 x 280	1	A-80802
25 x 300	1	D-34207
25 x 400	1	A-80818
25 x 400	1	D-34213

## Scaling chisel for SDS-MAX hammers



Size (mm)	Sales Pkg Qty	Part No.
50 x 400	1	A-80824
50 x 400	1	B-64288
50 x 400	1	D-34235

## Scaling chisel for SDS-MAX hammers/ Tile



Size (mm)	Sales Pkg Qty	Part No.
50 x 300	1	A-80830

## Ground rod driver for SDS-MAX hammers

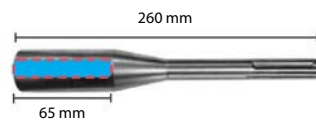

Diameter Size (Inside)(mm)	Shank	Part No.
13.3	SDS-MAX	E-13029
16.5		E-13035
22.2		E-13041

## Clay spade for SDS-MAX hammers



Size (mm)	Sales Pkg Qty	Part No.
105 x 400	1	A-17653

## Rammer for SDS-MAX hammers

Use with shank (A-19897)

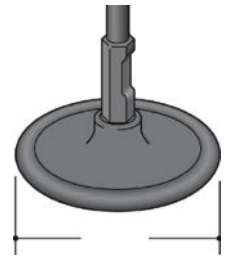

Size (mm)	Sales Pkg Qty	Part No.
140	1	A-19875

## Bushing tool for SDS-MAX hammers

Use with shank (A-19897)



Size (mm)	Sales Pkg Qty	Part No.
60 x 60x 50	1	A-19881

## Shank adapter for SDS-MAX hammers

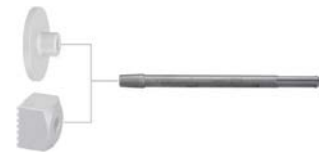

Size (mm)	Sales Pkg Qty	Part No.
250	1	A-19897

## SDS Max to SDS Plus adaptor

MAX



18mm



PLUS



10mm



Size (mm)	Sales Pkg Qty	Part No.
220	1	P-17027

# Drilling (Masonry)

## Bull point for 17mm Hex shank hammers



Size (mm)	Sales Pkg Qty	Part No.
255	1	D-71283
280	1	D-08682
450	1	D-16863



## Cold chisel for 17mm Hex shank hammers



Size (mm)	Sales Pkg Qty	Part No.
17 x 280	1	A-80569
19 x 210	1	D-26587
19 x 280	1	D-08707
19 x 450	1	D-16879
22 x 255	1	D-71299

## Bull point for 17mm Hex shank hammers/ Sharper edge



Size (mm)	Sales Pkg Qty	Part No.
280	1	D-26303
450	1	D-29860

## Scaling chisel for 17mm Hex shank hammers



Size (mm)	Sales Pkg Qty	Part No.
50 x 280	1	D-20694
50 x 450	1	D-52548

# Drilling (Masonry)

## Grooving chisel for 17mm Hex shank hammers



Size (mm)	Sales Pkg Qty	Part No.
22 x 280	1	A-48555
26 x 280	1	A-48561

## Chisel set for 17mm Hex shank hammers



Description	Description	Each	Sum	Part No.
Bull Point	255	1	3	D-71320
Cold Chisel	22 x 255	1		
Scaling Chisel	40 x 255	1		

## Bushing tool for 17mm Hex shank hammers



Size (mm)	Length (mm)	Sales Pkg Qty	Part No.
60 x 60	270	1	A-21484

## Bull point for 21mm Hex shank hammers



Length (mm)	Sales Pkg Qty	Part No.
320	1	D-16499
450	1	D-23824
600	1	D-30994

## Cold chisel for 21mm Hex shank hammers



Size (mm)	Sales Pkg Qty	Part No.
26 x 320	1	D-17588
26 x 450	1	D-17594

## Scaling chisel for 21mm Hex shank hammers



Size (mm)	Sales Pkg Qty	Part No.
70 x 320	1	D-20672



## Bull point for 28.6mm Hex shank hammers



Size (mm)	Sales Pkg Qty	Part No.
350	1	D-65034
410	1	D-17631

## Bull point for 28.6mm Hex shank hammers/ Self-sharpening

Self sharpening



Length (mm)	Sales Pkg Qty	Part No.
400	1	B-10372

# Drilling (Masonry)

## Cold chisel for 28.6mm Hex shank hammers



Size (mm)	Sales Pkg Qty	Part No.
28x410	1	D-17647

## Scaling chisel for 28.6mm Hex shank hammers



Size (mm)	Sales Pkg Qty	Part No.
75x410	1	D-29228

## Bull point for 30mm Hex shank hammers



Length (mm)	Sales Pkg Qty	Part No.
400	1	D-15285

## Cold chisel for 30mm Hex shank hammers



Size (mm)	Sales Pkg Qty	Part No.
30x400	1	D-15300

## Scaling chisel for 30mm Hex shank hammers



Size (mm)	Sales Pkg Qty	Part No.
75x310	1	D-23868

## Bull point for Makita small shank

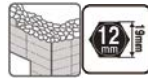

Length (mm)	Sales Pkg Qty	Part No.
220	1	B-06921

## Scaling chisel for Makita small shank



Size (mm)	Sales Pkg Qty	Part No.
30x150	1	B-07331
50x150	1	B-07347

## Scraper Assembly for Makita small shank



Length (mm)	Type	Part No.
100x160	-	A-68155
100	Cutter	343411-9





# ACCESSORIES

## Fastening

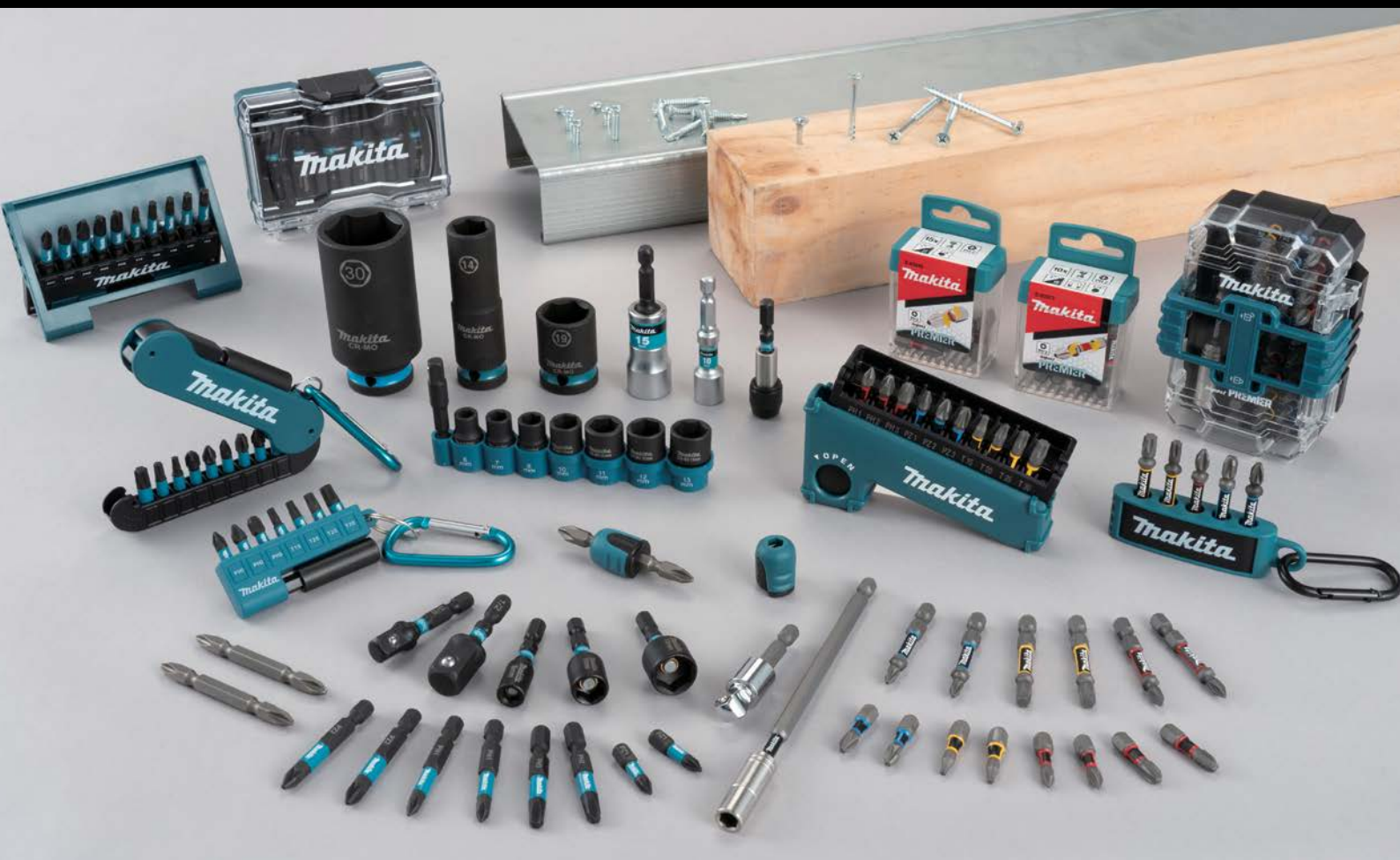

Wood



Magnet



Double end



Flexible



Pin ring



6.35 Hex shank MZ



6.35 Hex shank NZ



6.35 hex shank C form



Hex shank

# Drilling (Fastening)

## Fastener drive and screwdriving series

<b>1. C-form</b> 	
<b>2. E-form</b> 	
<b>3. Double ended</b> 	
<b>4. Bit holder</b> 	
<b>5. Nutsetter</b> 	
<b>6. Assortment</b> 	
<b>7. Socket adapter / Socket bit</b> 	
<b>8. Impact socket</b> 	
<b>9. Other</b> 	

**Impact**

# PREMIER

*Double Torsion  
for High Durability.*



*New Steel  
is Used.  
Supports High Torque.*

*High Precision  
Screw Fitting.*

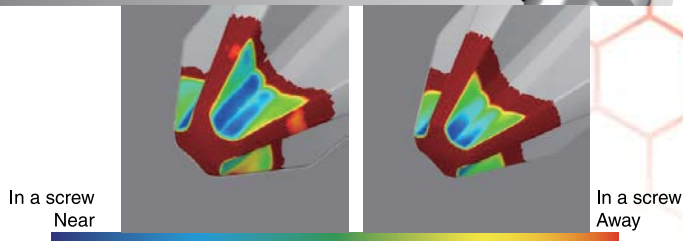
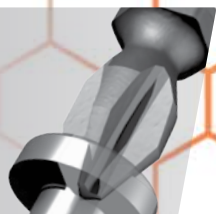

**Impact  
PREMIER**

**STANDARD**

Torque

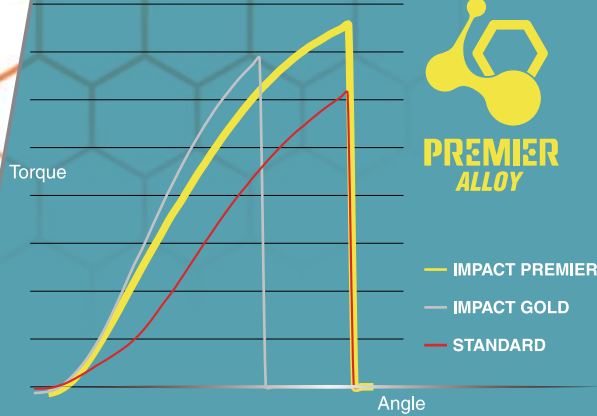

Angle

# NEW INNOVATION



# Drilling (Fastening)

## Screw Bit

1/4" Hex Shank (C-form)		
A	C-form	

1/4" Hex Shank (E-form)	NZ	MZ
E-form (Single Ended)	14mm 	9.5mm 
E-form (Double Ended)	17mm 	11mm 

## Drive type

Philips (PH)	PZ	Hex (H)	T	TH	Square (SQ)	Slotted (SL)

## Bit piece for screwdriver & impact driver

Part No.
322279-6

## Magnetic bit holder for screwdriver

Shank Type	Length (mm)	Sales Pkg Qty	Part No.
E-form (MZ)	60	1	784811-8
	76	1	784801-1

## Flexible bit holder

Shank Type	Overall Length (mm)	Sales Pkg Qty	Part No.
1/4 Inch Hex	300	1	B-29094

## Flexible tough bit holder

Shank Type	Overall Length (mm)	Sales Pkg Qty	Part No.
E-form (NZ)	300	1	B-51851

## Screw bit for screwdriver (E-form)

Size	Shank Type	Length (mm)	Sales Pkg Qty	Part No.
	E-form (NZ)	122	5	A-45858
		132	5	A-16536
		162	5	B-10481
		182	5	B-10475

## Screw bit blister 3pcs set (C-form)

Size	Shank Type	Length (mm)	Sales Pkg Qty	Part No.	
	PH 2	C-form	25	3	B-23466

## Screw bit blister 1pc, 3pcs set (E-form)

Size	Shank Type	Length (mm)	Sales Pkg Qty	Part No.	
	E-form (NZ)	H3	50	3	D-74930
		H4	50		D-74946
		H5	50		D-74952
		H6	50	1	D-74968
		H3	90		D-74974
		H4	90		D-74980
		H5	90		D-74996
		H6	90		D-75007
		H3	150		D-75013
		H4	150	D-75029	
		H5	150	D-75035	
		H6	150	D-75041	

# Drilling (Fastening)



**Torsion screw bit C-form Impact PREMIER with bit holder Assortment**



Shank Type	Sales Pkg Qty	Part No.
C-form & E-form (MZ)	11	E-03567

**Mag boost Impact PREMIER**



Range	Sales Pkg Qty	Part No.
★★★★★	1	E-03442

**Socket Adapter set**

It allows impact driver to fasten or loosen bolt and nut.  
8,10,12,13,14,15,17,18mm  
Socket adapter 50mm



Size	Shank Type	Sales Pkg Qty	Part No.
SQ 1/2"	NZ-B	1	B-55762



**Impact BLACK screw bit set**



Shank Type	Sales Pkg Qty	Part No.
C-form & E-form (NZ)	8	E-14227
E-form (NZ)	10	E-14233
C-form & E-form (NZ)	33	E-06622

**Double ended screw bit E-form Impact BLACK**



Bit Type	Shank Type	Length (mm)	Sales Pkg Qty	Part No.
PH2	E-form (NZ)	65	10	E-15827
PH2	E-form (NZ)	110	10	E-15833

**Screw bit E-form Impact BLACK**



Bit Type	Shank Type	Length (mm)	Sales Pkg Qty	Part No.
PH2	E-form (NZ)	50	2	E-08763

**Magnetic bit holder E-form Impact BLACK**



Shank Type	Length (mm)	Sales Pkg Qty	Part No.
E-form (NZ)	60	1	E-08785

# Drilling (Fastening)

## Socket adapter E-form Impact BLACK



Bit Type	Shank Type	Length (mm)	Sales Pkg Qty	Part No.
1/2 inch Drive	E-form (NZ)	50	1	E-08850

## Impact BLACK sleeve chuck bit holder



Length(mm)	Sales Pkg Qty	Part No.
76	1	E-24941
152	1	E-24957
304	1	E-24963

## 43pcs. Color screw bit set / Clamshell

Magnetic nutsetter 6,8,10mm  
Sleeve chuck bit holder 60mm  
Screw guide bit holder 80mm



Shank Type	Sales Pkg Qty	Part No.
C-form & E-form	43	B-55697

## 12pcs. Screw Bit Set with magnetic bit holder

Case set with more compact and cost-performance



Shank Type	Sales Pkg Qty	Part No.
C-form & E-form (NZ)	12x12set	D-31011

## Double ended twist torsion screw bit

New generation torsion bit which is beyond the current torsion bit.



Size	Shank Type	Length (mm)	Sales Pkg Qty	Part No.	
+	PH 2	E-form (NZ)	65	3	A-67505
	PH 2 (Slim)		65	3	A-67511
	PH 2		90	3	A-59570
	PH 2 (Slim)		90	3	A-59601

## Double ended silver torsion screw bit

Torsion section flexes under load and takes pressure off bit tip



Size	Shank Type	Length (mm)	Sales Pkg Qty	Part No.	
+	PH 2	E-form (MZ)	85	3	B-12326
	PH 2	E-form (NZ)	65	3	A-49563
	PH 2		65	6	A-49579
	PH 2		85	3	A-49585
	PH 2	110	3	A-49600	
	PH 2	110	10	B-52037	
	PH 2	150	3	A-50120	

# Drilling (Fastening)

## Drill & drive bit

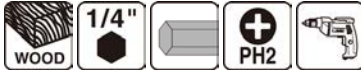

Shank Type	Bit Type	Length (mm)	Sales Pkg Qty	Part No.
1/4 inch hex shank	PH2	55	1	D-73209
				D-73215
				D-73221

## Bit adapter

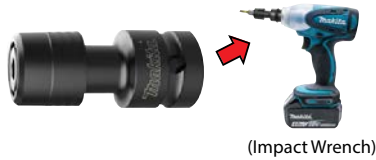

Shank Type	Bit Type	Length (mm)	Sales Pkg Qty	Part No.
3/8 Inch Drive	E-form (NZ)	57	1	B-68482
1/2 Inch Drive	E-form (NZ)	57	1	B-68476

## Double ended screw bit set



Size	Shank Type	Length (mm)	10pcs	
			Part No.	
+	PH 2	45	D-34827	
	PH 2	65	D-33679	
	PH 2	110	D-34833	
	PH 2	E-form (NZ) Slim	65	B-90015

## Battery type case



Part No.
B-69917

## Magnetic nutsetter



\*\* Magnetic Socket Bit



Shank Type	Socket Size (mm) / [inch]	Length (mm)	Sales Pkg Qty	Part No.
E-form (NZ)	7	50	1	D-78601
	8	50	1	D-78617
	10	50	1	D-78623
	12	86	1	784407-5 D-78639
	13	50	1	D-78645
	17	55	1	784416-4

## Magnetic nutsetter set



Shank Type	Bit Type	Length (mm)	Sales Pkg Qty	Part No.
NZ	6,8,10,12,13	50	5	B-39176

# Drilling (Fastening)

## Impact socket

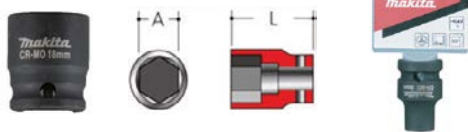

Shank Type	Socket Size (mm)	Length (mm)	Sales Pkg Qty	Part No.
3/8 Inch Drive	6	28	1	B-39883
	7	28	1	B-39899
	8	28	1	B-39908
	9	28	1	B-39914
	10	28	1	B-39920
	11	28	1	B-39936
	12	28	1	B-39942
	13	28	1	B-39958
	14	28	1	B-39964
	16	28	1	B-39986
	17	30	1	B-39992
	18	30	1	B-40004
	19	30	1	B-40010
	20	30	1	B-40026
1/2 Inch Drive	21	30	1	B-40032
	22	30	1	B-40048
	14	38	1	B-40113
1/2 Inch Drive	17	38	1	B-40141
	19	38	1	B-40163

## Impact socket



Shank Type	Socket Size (mm)	Length (mm)	Impact Socket	
			Part No.	
1/2 Inch Drive	10	38	B-10497	
	12	38	A-89931	
	13	38	134825-1	
	13	52	134827-7	
	14	38	134826-9	
	14	52	134828-5	
	16	38	B-10506	
	17	38	134829-3	
	19	38	134831-6	
	21	38	134838-2	
	21	52	134833-2	
	22	38	134851-0	
	23	38	134840-5	
	26	50	134842-1	
	1/2 Inch Drive	22	52	A-85553
		24	52	A-85575
26		52	134853-6	
30		52	134857-8	
32		52	134871-4	
1 Inch Drive	35	80	134864-1	
	36	80	134865-9	
	41	80	134872-2	

## Impact deep socket (Bulk)



Shank Type	Socket Size (mm)	Length (mm)	Sales Pkg Qty	Part No.	
1/2 Inch Drive	12	75	1	134867-5	
	19	78	1	134837-4	
	21	78	1	134839-0	
	27	78	1	134845-5	
	30	78	1	134847-1	
	32	78	1	134849-7	
	3/4 Inch Drive	17	95	1	A-85503
		19	95	1	A-85525
		21	95	1	A-85547
		26	95	1	134854-4
27		95	1	134856-0	
30		95	1	134858-6	
35		95	1	134861-7	
36		95	1	134863-3	

## Impact socket set



(With pin and O ring)  
10,11,13,17,19,21,22, 24, 27 mm



Shank Type	Socket Size (mm)	Length (mm)	Sales Pkg Qty	Part No.
1/2 Inch Drive	10 to 27	38	9	B-69749



# Drilling (Fastening)

## Semi long socket bit



Shank Type	Socket Size (mm)	Length (mm)	Sales Pkg Qty	Part No.
E-form (NZ)	8	90	1	A-58914
	10	90	1	A-58920
	12	90	1	A-58936
	14	90	1	A-58958

## Hollow socket bit



Shank Type	Socket Size (mm)	Length (mm)	Sales Pkg Qty	Part No.
E-form (MZ)	10	75	1	B-52526
	10	150	1	B-52532
	10	300	1	B-52548
	10	500	1	B-52554
	10	700	1	B-52560
	13	75	1	B-52576
	13	150	1	B-52582
	13	300	1	B-52598
	13	500	1	B-52607
	13	700	1	B-52613
	17	75	1	B-52629
	17	150	1	B-52635
	17	300	1	B-52641
	17	500	1	B-52657
	17	700	1	B-52663

## Bit Catcher



Part No.
B-63105

## Threaded rod socket bit



Shank Type	Socket Size	Length (mm)	Sales Pkg Qty	Part No.
E-form (MZ)	M6	66	1	B-42961
	M10	66	1	B-42983
	3/8"	66	1	B-51611
	1/2"	66	1	B-51627

## Socket extension



Shank Type	Bit Type	Length (mm)	Sales Pkg Qty	Part No.
1/2 Inch Drive	1/2 Inch Drive	75	1	B-55728
		150	1	B-55712
		250	1	B-55706



# ACCESSORIES

## ▣ Drill and Screw Bit Sets



# Drill and Screw Bit Sets



## MAKPAC 65pcs. Set for SDS-PLUS

### In the set:

HSS-TiN drill bit for SDS-PLUS x8pcs.  
 Wood drill bit for SDS-PLUS x5pcs, Masonry drill bit for SDS-PLUS x5pcs,  
 Screw bit 25mm x40pcs. ,Nutsetter x4pcs.  
 Countersink, Sleevechuck bitholder for SDS-PLUS, Tape Measure 3m



Metric Size

Part No.

B-69478

# Drill and Screw Bit Sets



## 103pcs. Bit & Hand tool display set

### In the set:

Masonry drill x7pcs.  
 Wood drill x7pcs.  
 Flat bit x3pcs.  
 HSS-R drill bit x11pcs, Hole saw, Hole saw arbor, Depth stop, Tape Measure 3m, Diameter gauge 1-10mm, Hex key wrench, Level, Countersink, Screw bit 25mm x24pcs, Magnetic bit holder, Socket x7pcs.  
 Socket adapter for 25mm screw driver, Long nose plier, Combination plier, Adjustable wrench, Nail hammer metric



Metric Size
Part No.
D-42341

## Wood Brad Point Drill Bit Set

Sales pkg qty: 8

### In the set:

3, 4, 5, 6, 7, 8, 9 10mm  
 drill bits



Metric Size
Part No.
D-77257

## Drill bit 9pc. assortment

Sales pkg qty: 9



Diameter(mm)			Metric Size
Masonry	Metal	Wood	Part No.
5, 6, 8mm	5, 6, 8mm	5, 6, 8mm	D-71962

## Drill & Screw bit Set 17pc. assortment

Sales pkg qty: 17

### In the set:

Drill Bits:  
 Masonry drill: 5, 6, 8mm  
 Wood drill: 5, 6, 8mm  
 Metal drill: 5, 6, 8mm  
 Screw Bits:  
 PH1, PH2, PH3, PZ2, H4, H5, SL5  
 & Sleeve Chuck Bit Holder.



Metric Size
Part No.
D-77207

# ACCESSORIES

## ▣ Cutting



Wood



Plaster board



Epoxy



Plastic



Fiberglass



TC grit 30-40



TC grit 40-50











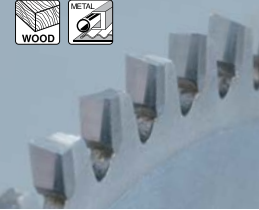

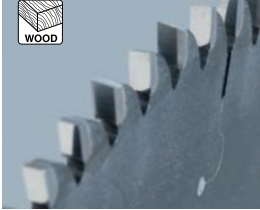





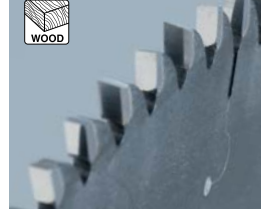
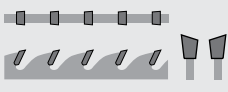
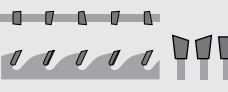
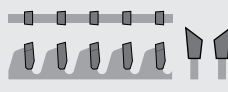
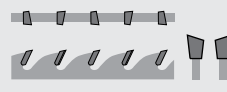
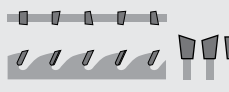

Low noise



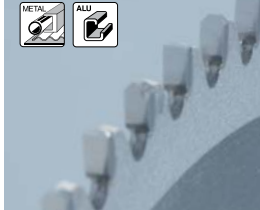

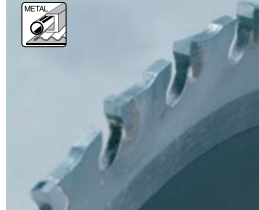
# Cutting

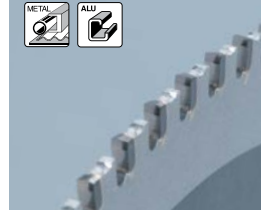
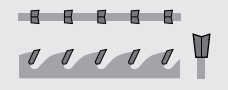
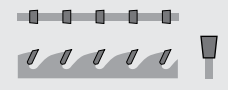
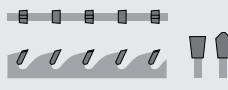
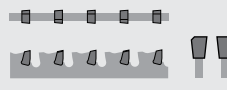
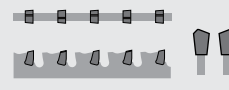
## T.C.T Saw Blade

### Tooth shape

<p><b>ATB</b></p>  	<p><b>ATBR</b></p>  	<p><b>Hi-ATB</b></p>  	<p><b>ATAF</b></p>  	<p><b>ATAFR</b></p>  
<p>Alternate top bevel For wood and aluminum.</p>	<p>Added flat teeth to ATB for easy straight cutting</p>	<p>Alternate top bevel (ATB) with a larger top bevel angle</p>	<p>Alternate top alternate face Enables to cut wood fiber sharply.</p>	<p>Added flat teeth to ATAF for easy straight cutting. <b>MATAFR:</b> Modified ATAFR for less cutting resistance.</p>
				
<p><b>M-FORCE</b></p>  	<p><b>FTG</b></p>  	<p><b>TCG</b></p>  	<p><b>MTCG</b></p>  	<p><b>SMTCG</b></p>  
<p>Tooth front and top shapes symmetric V groove having features of ATB and FTG.</p>	<p>Flat teeth, allows easy straight cutting and tips are rarely chipped. For cutting wood along the grain and cutting thin metal.</p>	<p>Trapezoidal and flat teeth are arranged alternatively and they divide debris by three. Allows easy straight cutting and tips are rarely chipped.</p>	<p>Flat teeth with alternating bevel Less cutting resistance than flat teeth. Tips are rarely chipped</p>	<p>Contrast to MTCG, asymmet- ric two bevels on a tooth top producing sharp edges Allows easy bite to materials.</p>
				

### Technical term

<p><b>Laser Slit</b></p> 	<p><b>Coated</b></p> 	<p><b>Tip Embedded</b></p> 	<p><b>P.C.D Tip</b></p> 
<p>Vibration dampening system Resinbond filled laser cut body slots for smoother and quieter cuts.</p>	<p>PTFE (polytetrafluoroethylene) coating plate to reduce pitch build-up and to lower resistance.</p>	<p>Inserted tooth design will greatly increase the body-to-tip braze area for greater support and tip strength.</p>	<p>PCD (Poly-Crystalline Diamond) tips has extreme hardness and wear resistance. PCD tipped saw blade is the best choice for long lasting performance when cutting fiber cement board.</p>



## Feature



### Sharp top angle



Enable you to make a fine cut surface with only little effort.



### Curved body



Allows the excellent chip chute performance.



### Slimmed bottom



Realizes long life battery by saving cutting resistance.

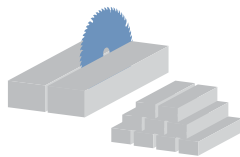

## More cuts per charge



## Fast cutting



## Longer life

## The amount of cutting per 1 charge

Plate: 1.6mm



165mm x 48T

Plate: 1.0mm



165mm x 50T

**EFFICUT**

100

× 2.4  
more

240

The test results depend to a great extent on the hardness of wood materials, etc.



This movie was filmed in Japan.  
Models and specs may vary by country.



★★★★★

for Wood  
Ideal for Cordless Circular Saw



Outer dia (mm)	Range	Material	No. of teeth	Kerf (mm)	Plate (mm)	Rake	Tooth shape	Bore (mm)	Ring (mm)	Note	Per pkg	Part No.
165	★★★	Wood	24	1.6	1.0	20	ATAFR	20	-	-	1	E-15665
		Wood	25	1.4	1.0	23	ATAFR	20	-	-	1	B-63018
	★★★★★	Wood/MDF	56	1.45	1.0	23	ATAFR	20	-	-	1	B-57364
		Wood	60	1.45	1.0	23	ATAFR	20	-	-	1	B-69892
185	★★★	Wood	24	1.6	1.0	23	ATAFR	20	-	-	1	E-15671
		Wood	24	1.45	1.0	23	ATAFR	20	-	-	1	B-62022
	★★★★★	Wood	45	1.45	1.0	23	ATAFR	20	-	-	1	B-68616
★★★★★		Wood	24	1.45	1.0	23	ATAFR	20	-	-	1	B-64200
	190	★★★★★	Wood	45	1.45	1.0	23	ATAFR	20	-	-	1
235			★★★★★	Wood	24	2.2	1.5	20	ATBR	25	-	1

Ideal for Cordless Plunge Saw



Outer dia (mm)	Range	Material	No. of teeth	Kerf (mm)	Plate (mm)	Rake	Tooth shape	Bore (mm)	Ring (mm)	Note	Per pkg	Part No.
165	★★★★★	Wood/MDF	56	1.45	1.0	23	ATAFR	20	-	for Plunge Cut Circular Saw	1	B-57364

# Cutting

## Ideal for Cordless Metal Cutter



Outer dia (mm)	Range	Material	No. of teeth	Kerf (mm)	Plate (mm)	Rake	Tooth shape	Bore (mm)	Ring (mm)	Note	Per pkg	Part No.
150	★★★★★	Wood	25	1.4	1.0	23	ATAFR	20	-	for Metal Cutter	1	E-06937

## Ideal for Cordless Slide Compound Saw



Outer dia (mm)	Range	Material	No. of teeth	Kerf (mm)	Plate (mm)	Rake	Tooth shape	Bore (mm)	Ring (mm)	Note	Per pkg	Part No.
165	★★★★★	Wood	60	1.85	1.4	10	ATBR	20	-	-	1	B-69892
216	★★★★★	Wood	45	2	1.5	10	ATBR	25.4	-	-	1	E-07010
260	★★★★★	Wood	45	2.15	1.7	10	ATBR	25.4	-	-	1	B-64668
		Wood	60	2.15	1.7	10	ATBR	25.4	-	-	1	B-67430
		Wood	80	2.15	1.7	10	ATBR	25.4	-	-	1	B-67446
305	★★★★★	Wood	60	2.15	1.7	10	ATBR	25.4	-	-	1	B-67452
		Wood	80	2.15	1.7	10	ATBR	25.4	-	-	1	B-67468
		Wood	100	2.15	1.7	10	ATBR	25.4	-	-	1	B-67474

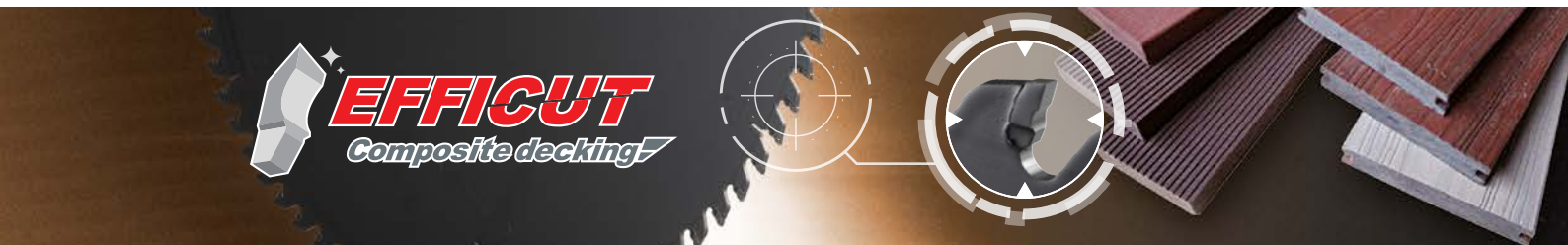

## Feature

### Curved body



Allows the excellent chip chute performance.

### Slimmed bottom



Realizes long life battery by saving cutting resistance.

### The amount of cutting per 1 charge

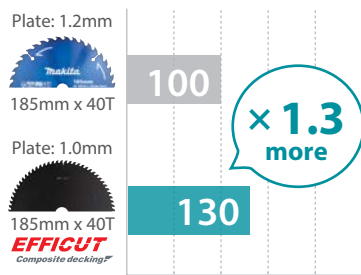

Model: DHS780 (BL1860B)  
Material : Composite decking  
(WxH =137mm x 23mm)

Following the tooth design of Efficut for wood with

- Tip hardness was improved
- Having obtuse tip angle then realized longer life and more cuts per charge.

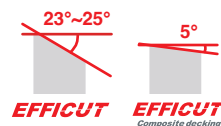

### Life

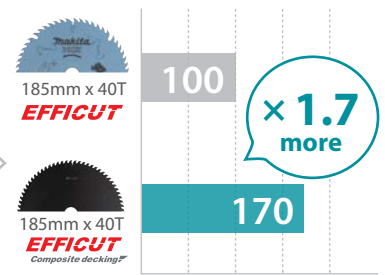

Model: DRS780 (BL1860)  
Material : Composite decking  
(WxH =139mm x 22mm)

★★★★★

for Composite deck

Ideal for Cordless Circular Saw



Outer dia (mm)	Range	Material	No. of teeth	Kerf (mm)	Plate (mm)	Rake	Tooth shape	Bore (mm)	Ring (mm)	Note	Per pkg	Part No.
185	★★★★★	Composite	40	1.50	1.00	15	ATAFR	20	-	-	1	E-11972
260	★★★★★	Composite	75	2.15	1.65	8	ATAFR	25.4	-	-	1	E-11988



## Feature

**Strong and least chipping**

Special blade tip design greatly improves efficiency and durability.

**Release swarf smoothly**

**Superior in straight cutting**

The load on blade tips can be distributed efficiently to suppress wobbling of saw blade, providing steady straight cutting and increased durability against tip breakage.

**More cuts per charge**

**Fast cutting**

**Longer life**

The amount of cutting per 1 charge

Plate: 1.2mm



150mm x 32T

Plate: 0.95mm



150mm x 33T

**EFFICUT Metal**

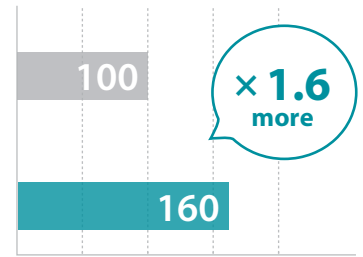

Model: DCS553 (BL1860B)

Material: Carbon steel pipe (Dia: 31mm / Thickness: 3mm)



This movie was filmed in Japan.  
Models and specs may vary by country.

★★★★★

**for Metal**

**Ideal for Cordless Metal Cutter**

Outer dia (mm)	Range	Material	No. of teeth	Kerf (mm)	Plate (mm)	Rake	Tooth shape	Bore (mm)	Ring (mm)	Note	Per pkg	Part No.
136	★★★★★	Metal	30	1.1	1.0	0	SMTCCG	20	-	-	1	B-69428
		Metal & SUS	45	1.1	1.0	0	SMTCCG	20	-	-	1	B-69434
150	★★★★★	Metal	33	1.1	1.0	0	SMTCCG	20	-	-	1	B-69440
		Metal & SUS	48	1.1	1.0	0	SMTCCG	20	-	-	1	B-69456
185	★★★★★	Metal	45	1.4	1.2	0	SMTCCG	20	-	-	1	E-12918
		Metal & SUS	60	1.4	1.2	0	SMTCCG	20	-	-	1	E-12924

**Ideal for Cordless Steel Rod Cutter**



Outer dia (mm)	Range	Material	No. of teeth	Kerf (mm)	Plate (mm)	Rake	Tooth shape	Bore (mm)	Ring (mm)	Note	Per pkg	Part No.
110	★★★★★	Metal	24	1.5	1.1	0	SMTCCG	34	-	EAC mark only	1	E-11097

**Ideal for Cordless Metal Cutting Saw**



Outer dia (mm)	Range	Material	No. of teeth	Kerf (mm)	Plate (mm)	Rake	Tooth shape	Bore (mm)	Ring (mm)	Note	Per pkg	Part No.
305	★★★★★	Metal	63	2.0	1.75	-2	SMTCCG	25.4	-	-	1	E-12083

## Feature

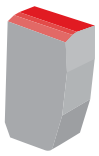

### Strong and least chipping



Special blade tip design greatly improves efficiency and durability.

### Superior in straight cutting

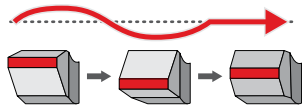

The load on blade tips can be distributed efficiently to suppress wobbling of saw blade, providing steady straight cutting and increased durability against tip breakage.



### Reduce cutting resistance



Realizes high durability and reduce cut resistance.

### Allows the excellent chip ejection.



Realizes long life battery by saving cutting resistance.

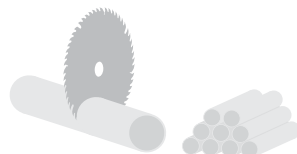

## More cuts per charge



## Fast cutting



## Longer life

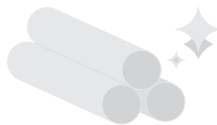

## Clean cutting

### The amount of cutting per 1 charge

Plate: 1.6mm



260mm x 80T

Plate: 1.0mm



260mm x 81T

**EFFICUT**  
Aluminum

100

× 1.4  
more

140

Model: DLS110(BL1860B x2)

Material : Aluminum frame (WxH=45x45mm, t=2mm)



VIDEO CLIP

This movie was filmed in Japan.  
Models and specs may vary by country.

★★★★★

**for Aluminum**  
**Ideal for Cordless Slide Compound Saw**



Outer dia (mm)	Range	Material	No. of teeth	Kerf (mm)	Plate (mm)	Rake	Tooth shape	Bore (mm)	Ring (mm)	Note	Per pkg	Part No.
260	★★★★★	Aluminum	81	1.85	1.5	-3	SMTCG	25.4	-	-	1	E-06345

# Cutting

## For Wood

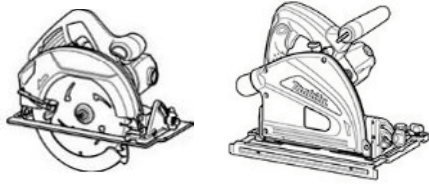

(Circular Saw) & (Plunge Cut Circular Saw)



Outer dia (mm)	Range	Material	No. of teeth	Kerf (mm)	Plate (mm)	Rake	Tooth shape	Bore (mm)	Ring (mm)	Note	Per pkg	Part No.
85	★★★	Wood	20	1.00	0.70	10	ATB	15	-	for Cordless Saw	1	B-14607
		Wood	50	0.50	0.50	-	-	15	-	for Cordless Saw	1	792259-0
		Plastics	50	0.50	0.50	-	-	15	-	for Cordless Saw	1	792299-8
110	★★	Wood	24	1.70	1.10	10	ATB	20	-	-	1	D-15578
136	★★★	Wood	16	1.50	1.00	20	ATAF	20	-	for Cordless Saw	1	B-09949
	★★★	Wood/MDF	40	1.50	1.00	20	ATAF	20	-	for Cordless Saw	1	D-59156
160	★★★	Wood	24	2.20	1.40	25	ATAF	20	-	-	1	A-81371
		Wood	40	1.60	1.00	18	ATB	20	-	-	1	A-80612
		Wood	40	1.80	1.20	20	ATAF	20	-	Economy	1	B-16994
		Wood	40	2.20	1.40	20	ATAF	20	-	-	1	A-81898
165	★★★★★	Wood	25	1.40	1.00	23	ATAFR	20	-	EFFICUT	1	B-63018
	★★★	Wood	28	2.20	1.60	15	ATB	20	-	for Plunge Cut Circular Saw	1	B-07434
		Wood	40	1.60	1.00	18	ATAF	20	-	for Cordless Saw	1	A-85226
		Wood	40	2.00	1.20	20	-	20	-	-	1	P-67929
		Wood	44	1.45	1.00	23	ATAFR	20	-	-	1	B-53285
		Wood	64	1.90	1.40	10	ATAF	20	-	-	1	B-56487
		Wood/NAIL	16	2.00	1.25	23	ATB	20	-	-	1	A-86022
Wood/NAIL	24	2.00	1.25	23	ATB	20	-	-	1	A-86038		

# Cutting

Outer dia (mm)	Range	Material	No. of teeth	Kerf (mm)	Plate (mm)	Rake	Tooth shape	Bore (mm)	Ring (mm)	Note	Per pkg	Part No.	
165	★★	Wood	40	2.00	1.30	18	ATB	20	-	-	1	D-03349	
	★	Wood	40	2.00	1.20	12	ATB	20	-	-	1	D-50500	
180	★★★	Wood	24	2.20	1.40	25	ATAF	20	-	-	1	A-81402	
		Wood	40	2.20	1.40	20	ATAF	20	-	-	1	A-81418	
185	★★★★★	Wood	45	1.45	1.00	23	ATAFR	20	-	EFFICUT	1	B-68616	
185	★★★	Wood	40	1.60	1.00	18	ATAF	20	-	-	1	A-82476	
		Wood	60	1.60	1.00	18	ATAF	20	-	-	1	A-82482	
		Wood/NAIL	40	2.00	1.25	25	ATB	30	20	-	-	1	A-86072
	★★	Wood	16	2.00	1.30	20	ATB	30	20/16	-	-	1	D-03903
		Wood	20	2.00	1.30	20	ATB	30	20/16	-	-	1	D-09634
		Wood	24	1.80	1.20	20	ATB	20	-	-	-	1	D-19037
		Wood	40	2.00	1.30	18	ATB	20	-	-	-	1	D-03361
		Wood	40	2.00	1.30	18	ATB	30	20/16	-	-	1	D-03919
		Wood	40	2.00	1.30	18	ATB	30	20/16	-	-	1	D-03919
	★	Wood	24	2.20	1.40	15	ATB	25.4	20	-	-	1	D-50522
Wood		40	2.20	1.40	14	ATB	25.4	20	-	-	1	D-50538	
190	★★★★★	Wood	24	1.45	1.00	23	ATAFR	20	-	EFFICUT	1	B-64200	
		Wood	45	1.45	1.00	23	ATAFR	20	-	EFFICUT	1	B-68644	
210	★★	Wood	24	2.00	1.30	20	ATB	25	-	-	1	D-29066	
235	★★★★★	Wood	24	2.20	1.50	20	ATBR	25	-	EFFICUT	1	E-01959	
	★★★	Wood	20	2.30	1.60	20	ATB	25	-	-	1	A-89947	
		Wood	60	2.60	1.80	20	ATAF	25.4	25	-	-	1	A-81474
	★★	Wood	20	2.40	1.60	20	ATB	30	25.4/25	-	-	1	D-03925
		Wood	40	2.40	1.60	18	ATB	25.4	25	-	-	1	D-03377
		Wood	60	2.40	1.60	15	ATB	30	25	-	-	1	D-09640
★	Wood	40	2.50	1.60	12	ATB	25.4	25	-	-	1	D-50550	
260	★★★	Wood	24	2.30	1.60	20	ATB	25.4	-	-	1	B-10584	
	★	Wood	40	2.60	1.80	15	ATB	30	-	EAC mark only	1	D-65377	
335	★★★	Wood	60	3.00	2.20	20	ATB	25	-	-	1	B-12603	
355	★★★	Wood	20	3.00	2.20	27	ATAF	30	-	-	1	A-80014	
		Wood	60	3.00	2.20	18	ATB	30	-	-	1	A-81854	



# Cutting

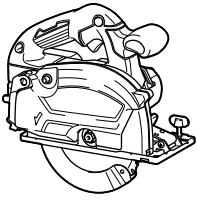

(Cordless Metal Cutter)

Outer dia (mm)	Range	Material	No. of teeth	Kerf (mm)	Plate (mm)	Rake	Tooth shape	Bore (mm)	Ring (mm)	Note	Per pkg	Part No.
150	★★★★★	Wood	25	1.40	1.00	23	ATAFR	20	-	EFFICUT	1	E-06937



(Slide Compound Saw / Miter Saw)

Outer dia (mm)	Range	Material	No. of teeth	Kerf (mm)	Plate (mm)	Rake	Tooth shape	Bore (mm)	Ring (mm)	Note	Per pkg	Part No.
165	★★★★★	Wood	60	1.85	1.35	10	ATBR	20	-	EFFICUT	1	B-69892
	★★★	Wood	64	1.90	1.40	10	ATAF	20	-	-	1	B-56487
190	★★★	Wood	24	2.00	1.40	-5	ATB	20	-	-	1	B-03866
		Wood	40	2.00	1.40	10	ATAF	20	-	-	1	A-86751
		Wood	72	2.00	1.40	10	ATAF	20	-	-	1	A-86359
210	★★★	Wood	18	1.90	1.40	25	ATB	30	25	-	1	A-81767
216	★★★★★	Wood	45	2.00	1.50	10	ATBR	25.4	-	EFFICUT	1	E-07010
	★	Wood	80	2.20	1.40	16	ATAF	25.4	-	-		D-75057
255	★★★	Wood	32	2.30	1.80	5	ATAF	25.4	-	EFFICUT	1	A-83696
		Wood	80	2.30	1.80	5	ATB	25.4	-	-	1	B-03648
	★	Wood	40	2.60	1.80	15	ATB	25.4	-	-	1	D-74055
260	★★★★★	Wood	45	2.15	1.65	10	ATBR	25.4	-	EFFICUT	1	B-64668
		Wood	60	2.15	1.65	10	ATBR	25.4	-	EFFICUT	1	B-67430
		Wood	80	2.15	1.65	10	ATBR	25.4	-	EFFICUT	1	B-67446
	★★★	Wood	64	2.30	1.80	5	ATAF	25	-	-	1	792695-0
		Wood	40	2.60	1.80	18	ATB	25.4	-	-	1	D-77338
		Wood	40	2.60	1.80	15	ATB	25.4	-	-	1	D-65414
305	★★★★★	Wood	100	2.60	1.80	12	ATB	25.4	-	-	1	D-65442
		Wood	60	2.15	1.65	10	ATBR	25.4	-	EFFICUT	1	B-67452
		Wood	80	2.15	1.65	10	ATBR	25.4	-	EFFICUT	1	B-67468
	★★★	Wood	100	2.15	1.65	10	ATBR	25.4	-	EFFICUT	1	B-67474
		Wood	40	2.30	1.80	5	ATB	30	-	BlueMak	1	B-54237
		Wood	60	2.30	1.80	5	ATAF	25.4	-	-	1	B-02808
		Wood	70	2.50	1.90	0	ATAF	25.4	-	-	1	B-57560
		Wood	96	2.30	1.80	5	ATAF	25.4	-	-	1	B-02814
		Wood	100	2.30	1.80	5	ATB	25.4	-	-	1	B-03698
	★	Wood	60	2.80	2.00	15	ATB	25.4	-	-	1	D-72366
Wood		80	2.80	2.00	15	ATB	25.4	-	-	1	D-72372	
355	★★★	Wood	100	2.80	2.00	15	ATB	25.4	-	-	1	D-72388

# Cutting



(Table Saw)

Outer dia (mm)	Range	Material	No. of teeth	Kerf (mm)	Plate (mm)	Rake	Tooth shape	Bore (mm)	Ring (mm)	Note	Per pkg	Part No.
203	★★★	Wood	40	2.00	1.40	20	ATAF	25.4	25	Economy	1	B-17120
		Wood	40	2.40	1.60	20	ATAF	25.4	25	-	1	A-81430
		Wood	60	2.00	1.40	15	ATAF	25.4	25	Economy	1	B-17142
		Wood	80	2.00	1.40	15	ATAF	25.4	25	Economy	1	B-17158
255	★★★	Wood	24	2.30	1.60	20	ATB	25.4	-	-	1	B-05000
		Wood	40	2.30	1.60	20	ATB	25.4	-	-	1	B-05088
		Wood	60	2.80	2.00	20	ATAF	25.4	25	-	1	A-81505
		Wood	80	2.40	1.80	15	ATAF	25.4	25	Economy	1	B-17295
		Wood	100	2.60	2.00	15	ATAF	25.4	25	-	1	A-82292
305	★★★	Wood	60	3.00	2.00	20	ATAF	25.4	25	-	1	A-82105
		Wood	100	3.00	2.20	15	ATAF	25.4	25	-	1	A-82323
355	★★★	Wood	80	3.00	2.20	20	ATAF	25.4	25	Economy	1	B-17463
		Wood	80	3.40	2.40	20	ATAF	25.4	25	-	1	A-81533
		Wood	100	3.40	2.40	15	ATAF	25.4	25	-	1	A-82351
405	★★★	Wood	80	3.60	2.60	20	ATAF	25.4	25	-	1	A-81561

## For Wood / MDF / Laminate

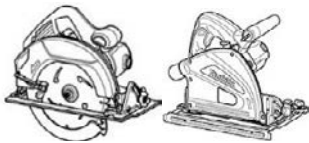

(Circular Saw) & (Plunge Cut Circular Saw)

Outer dia (mm)	Range	Material	No. of teeth	Kerf (mm)	Plate (mm)	Rake	Tooth shape	Bore (mm)	Ring (mm)	Note	Per pkg	Part No.
165	★★★★★	Wood/MDF/Laminate	56	1.45	1.00	23	ATAFR	20	-	EFFICUT	1	B-57364
	★★★★	Wood/MDF/Laminate	44	1.45	1.00	23	ATAFR	20	-	Coated / Laser Slit Specialized for cordless saws	1	B-53279
	★	MDF/Laminate	52	2.20	1.40	-5	TCG	20	15.88	-	1	D-62474
185	★★	MDF	60	2.40	1.50	12	TCG	30	20/16	-	1	D-17902



(Slide Compound Saw / Miter Saw)

Outer dia (mm)	Range	Material	No. of teeth	Kerf (mm)	Plate (mm)	Rake	Tooth shape	Bore (mm)	Ring (mm)	Note	Per pkg	Part No.
	★	MDF/Laminate	84	2.80	1.80	10	TCG	25.4	-	-	1	D-62480
		MDF/Laminate	100	2.80	1.80	10	TCG	25.4	15.88	-	1	D-72279
305	★	MDF/Laminate	96	3.00	2.00	10	TCG	25.4	-	-	1	D-62496

# Cutting

## For Metal

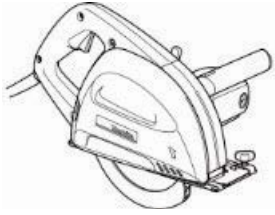

(Metal Cutter)

Outer dia (mm)	Range	Material	No. of teeth	Kerf (mm)	Plate (mm)	Rake	Tooth shape	Bore (mm)	Ring (mm)	Note	Per pkg	Part No.
136	★★★★★	Metal	30	1.10	0.95	0	SMTCG	20	-	EFFICUT Metal	1	B-69428
		Metal/SUS	45	1.10	0.95	0	SMTCG	20	-	EFFICUT Metal	1	B-69434
	★★★	Metal	30	1.50	1.20	0	MTCG	20	-	-	1	B-07319
		Metal/SUS	56	1.10	0.95	0	FTG	20	-	Laser Slit	1	B-23117
150	★★★★★	Metal	33	1.10	0.95	0	SMTCG	20	-	EFFICUT Metal	1	B-69440
		Metal/SUS	48	1.10	0.95	0	SMTCG	20	-	EFFICUT Metal	1	B-69456
	★★★	Thin sheet metal	52	1.40	1.10	-15	ATB	20	-	-	1	B-47008
		Metal	32	1.50	1.20	0	MTCG	20	-	-	1	B-46296
		Thick metal	32	1.10	0.95	0	TCG	20	-	Laser Slit	1	B-68301
		Metal/SUS	60	1.10	1.00	0	SMTCG	20	-	Laser Slit	1	B-47014
185	★★★	Thin metal	48	1.85	1.50	0	SMTCG	20	-	Long Life	1	B-23357
		Metal	36	1.90	1.50	0	ATB	20	-	-	1	B-04628
		Metal	38	2.00	1.60	0	MTCG	20	-	-	1	A-85438
		Metal	48	2.00	1.60	0	MTCG	20	-	-	1	A-83967
		Metal	56	1.80	1.50	0	SMTCG	20	-	Long Life	1	B-23391
		Metal	70	1.70	1.30	-10	FTG	20	-	-	1	A-86446
		Metal/SUS	64	1.60	1.30	0	FTG	20	-	Long Life	1	B-31697



(Metal Cutting Saw)

Outer dia (mm)	Range	Material	No. of teeth	Kerf (mm)	Plate (mm)	Rake	Tooth shape	Bore (mm)	Ring (mm)	Note	Per pkg	Part No.
305	★★★	Metal	60	2.10	1.70	0	TCG	25.4	-	Economy	1	A-87242
		Metal	60	2.40	2.00	0	TCG	25.4	-	Laser Slit	1	A-86723
		Metal	60	2.50	2.20	0	TCG	25.4	-	-	1	A-81860
		Metal	78	2.30	2.00	0	MTCG	25.4	-	Laser Slit	1	A-87127
	★★★★★	Metal/SUS	96	2	1.75	-3	SMTCG	25.4	-	EFFICUT Metal	1	E-19788
	★★★	Metal/SUS	100	1.95	1.65	-3	SMTCG	25.4	-	-	1	B-23151
	★★	Metal	60	2.40	2.00	0	TCG	25.4	-	-	1	D-71364

# Cutting

## for Aluminum

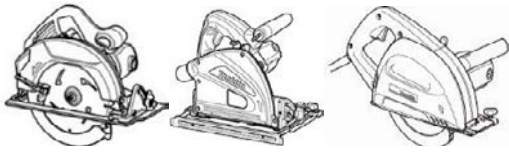

(Circular Saw) & (Plunge Cut Circular Saw) & (Metal Cutter)



Outer dia (mm)	Range	Material	No. of teeth	Kerf (mm)	Plate (mm)	Rake	Tooth shape	Bore (mm)	Ring (mm)	Note	Per pkg	Part No.
136	★★★	Aluminum	50	1.60	1.00	0	ATB	20	-	-	1	B-40331
150	★★★	Aluminum	52	1.60	1.00	0	ATB	20	-	-	1	B-47020
165	★★★★	Aluminum	56	2.00	1.40	-3	TCG	20	-	for Plunge Cut Circular Saw	1	B-56655
	★★★	Aluminum	56	2.40	1.70	-3	TCG	20	-	for Plunge Cut Circular Saw	1	B-07440

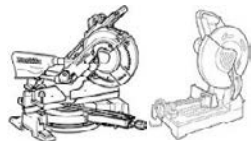

(Slide Compound Saw / Miter Saw) & (Metal Cutting Saw)

Outer dia (mm)	Range	Material	No. of teeth	Kerf (mm)	Plate (mm)	Rake	Tooth shape	Bore (mm)	Ring (mm)	Note	Per pkg	Part No.
165	★★★	Aluminum	60	1.80	1.20	5	TCG	20	-	Laser Slit	1	B-56530
185	★★★★★	Aluminum	60	1.7	1.35	0	SMTCG	20	-	EFFICUT Aluminum	1	E-16841
190	★★★	Aluminum	60	2.00	1.40	-5	TCG	20	-	-	1	B-03997
216	★★★★★	Aluminum	63	1.7	1.50	0	SMTCG	25.4	-	-	1	E-16944
190	★★★	Aluminum	60	2.00	1.40	-5	TCG	20	-	-	1	A-86767
255	★★★	Aluminum	100	2.60	2.00	0	ATB	25.4	25	Clean cut	1	A-81614
255	★★★	Aluminum	120	3.00	2.10	0	TCG	25.4	-	-	1	P-68018
260	★★★★★	Aluminum	81	1.85	1.50	-3	SMTCG	25.4	-	EFFICUT Aluminum	1	E-06345
	★★	Aluminum	100	3.00	2.00	5	TCG	25.4	-	-	1	D-03414
	★	Aluminum	100	2.60	1.80	5	TCG	25.4	-	-	1	D-59162
	★	Aluminum	70	3.00	2.00	5	TCG	25.4	-	-	1	D-73075
305	★★★★★	Aluminum	81	2.00	1.65	-3	SMTCG	25.4	-	EFFICUT Aluminum EFFICUT Aluminum	1	E-13281 E-13340
	★★	Aluminum	96	2.00	1.65	-3	SMTCG	25.4	-	-	1	E-13340
	★★	Aluminum	80	3.00	2.20	5	TCG	30	15.88	-	1	D-16520
	★	Aluminum	80	3.00	2.20	5	TCG	25.4	-	-	1	D-73081
355	★	Aluminum	100	3.00	2.20	5	TCG	25.4	-	-	1	D-73097
	★★★	Aluminum	80	3.00	2.20	5	TCG	25	-	-	1	A-02602
	★★	Aluminum	120	3.30	2.35	8	TCG	30	25	-	1	D-16592

## For Multi-purpose

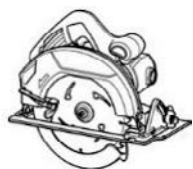

(Circular Saw)



Outer dia (mm)	Range	Material	No. of teeth	Kerf (mm)	Plate (mm)	Rake	Tooth shape	Bore (mm)	Ring (mm)	Note	Per pkg	Part No.
165	★	Wood,MDF,Aluminum,PVC	60	2.20	1.40	5	TCG	30	20/19/16/15.88	-	1	D-63616
185	★	Wood,MDF,Aluminum,PVC	60	2.20	1.40	5	TCG	30	20/16/15.88	-	1	D-63622
235	★	Wood,MDF,Aluminum,PVC	60	2.40	1.60	5	TCG	30	25.4/25/20/16	-	1	D-63557



# Cutting



(Slide Compound Saw / Miter Saw)

Outer dia (mm)	Range	Material	No. of teeth	Kerf (mm)	Plate (mm)	Rake	Tooth shape	Bore (mm)	Ring (mm)	Note	Per pkg	Part No.
260	★	Wood,MDF,Aluminum,PVC	120	2.60	1.80	5	TCG	30	25.4/25/20/16	-	1	D-62240
305	★	Wood,MDF,Aluminum,PVC	120	2.80	2.00	5	TCG	30	25.4/25/20/16	-	1	D-63591
355	★	Wood,MDF,Aluminum,PVC	100	3.00	2.20	5	TCG	30	25.4/25/20/16	-	1	D-63884

## For Others

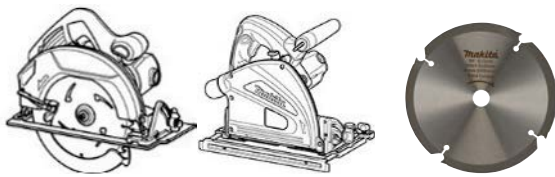

(Circular Saw) & (Plunge Cut Circular Saw)

Outer dia (mm)	Range	Material	No. of teeth	Kerf (mm)	Plate (mm)	Rake	Tooth shape	Bore (mm)	Ring (mm)	Note	Per pkg	Part No.
165	★★★	Sandwichpanel	42	1.75	1.40	0	SMTCG	20	-	-	1	B-63161
	★★	Fiber Cement Board	4	1.80	1.40	12	FTG	20	15.88	-	1	D-72104

## Ring Size for Miter Saw



(D) Hole Dia (mm)	(H) Outer Dia (mm)	Part No.
16	30	257262-3
15.88	25.4	257060-5

## Specialized for Aluminum Groove Cutter (CA5000)

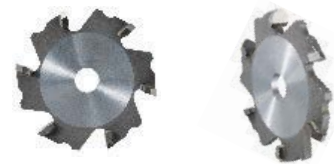

Outer dia (mm)	Range	Material	No. of teeth	Kerf (mm)	Plate (mm)	Rake	Tooth shape	Bore (mm)	Ring (mm)	Note	Per pkg	Part No.
118	Specialized	Aluminum composite panel	6	14.00	6.00	5	TCG	20	-	Grooving 90° for Aluminum Groove Cutter	1	B-48832
		Aluminum composite panel	6	18.00	6.00	5	TCG	20	-	-Grooving 135° for Aluminum Groove Cutter	1	B-48860

# ACCESSORIES

## ▣ Jigsaw / Reciprosawing

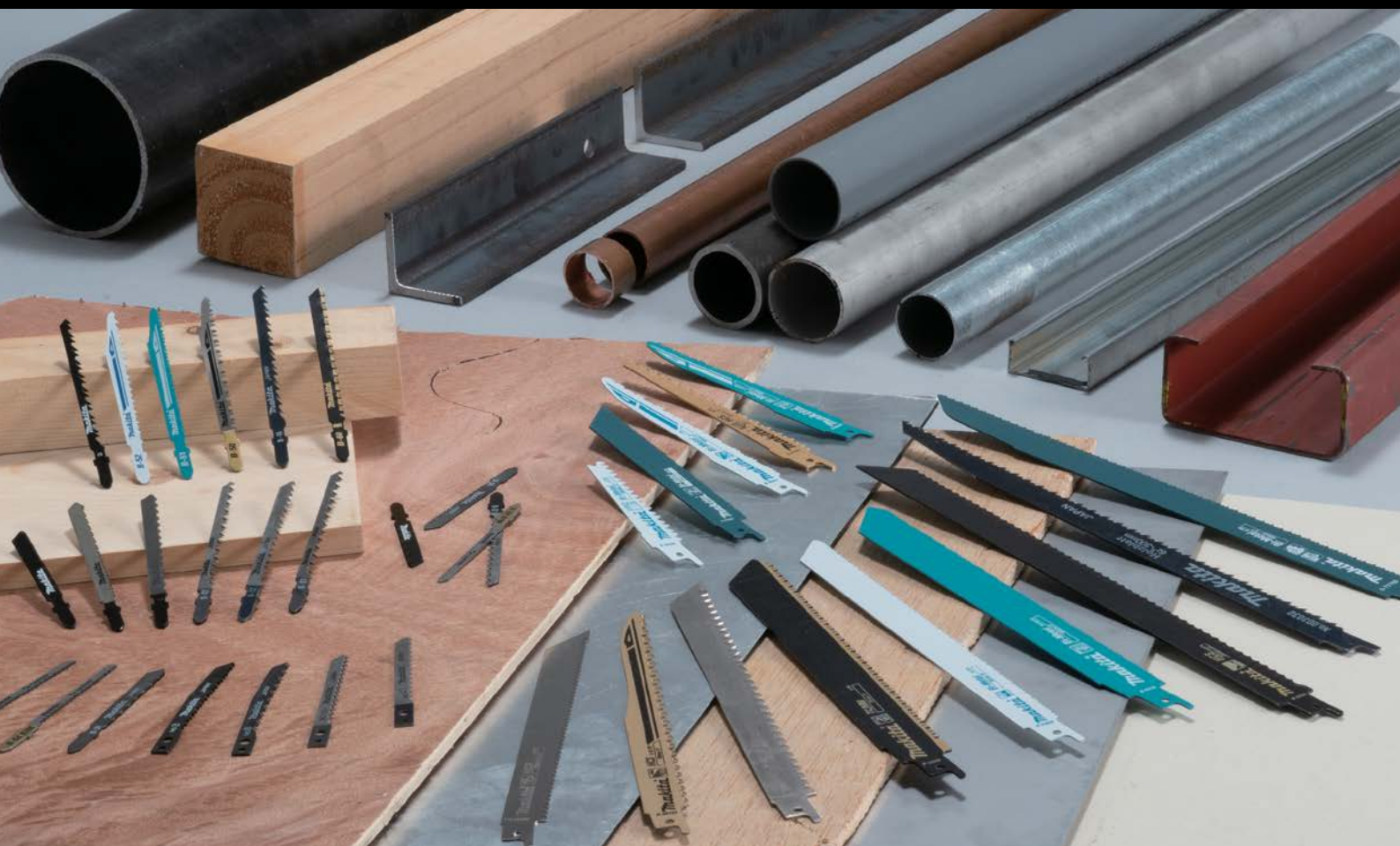

Metal, mild steel



Stainless steel



Aluminum



Wood



Non-ferrous metal



Wood with nails



Chipboard



Laminate board



Fiber cement board



Aerated concrete



Cast iron



Plaster board



Plastic



Fiberglass



Raker



Wave



Wave cut knife



Japanese teeth



Sharp edge



Makita Shank jig Saw Blade



Bayonet Shank jig Saw Blade

# Jigsaw / Reciprosawing

## Jig Saw blade

### Teeth Type

#### Milled and side set teeth

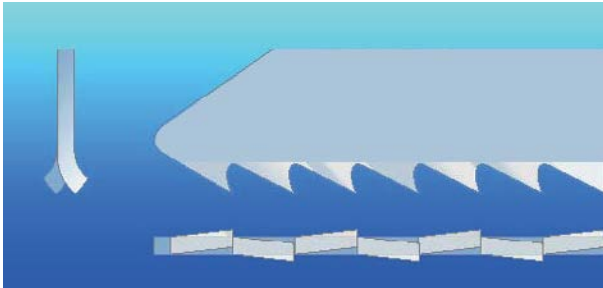

#### Ground and side set teeth

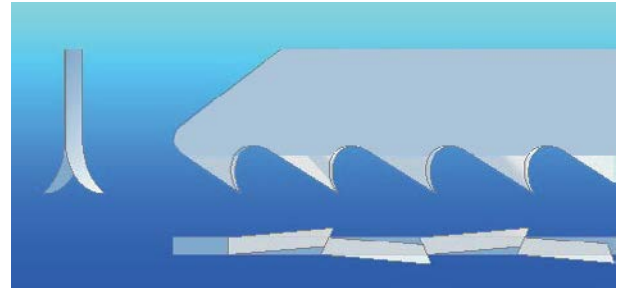

#### Milled and wavy set teeth

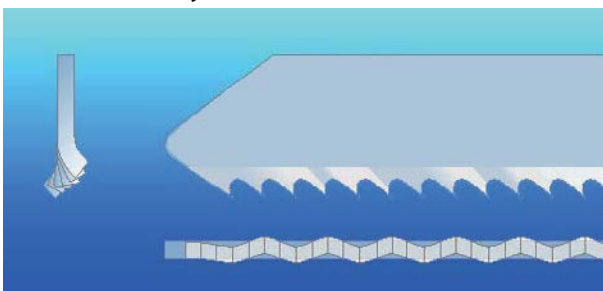

#### Ground and taper ground teeth

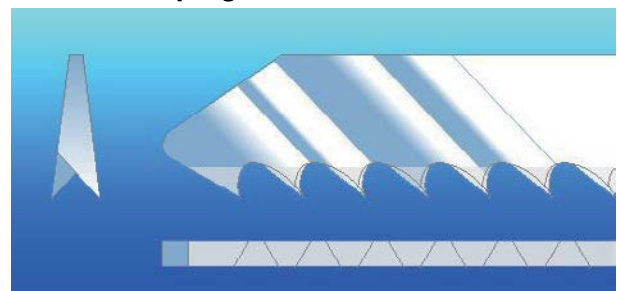

### Teeth manufacture

#### Milled teeth

- Low cost type of manufacturing
- For general cutting
- Soft to hard materials
- Long blade life



#### Ground teeth

- Costly type of manufacturing
- Very sharp!
- Accurate, clean cut
- Soft to medium hard materials

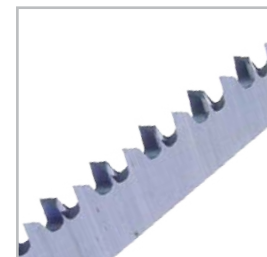

### Production method

- **Side set:** each individual tooth is alternately bent to the left and to the right. Raker setting  
Example: right, left, straight, etc.
- **Wavy set:** row of teeth receives a wave shape
- **Ground:** blade body tapers to the rear (conical)

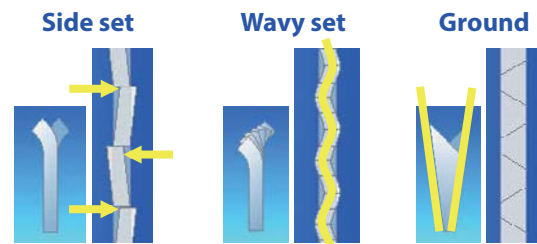

### Jig Saw Blade material

- **HCS (High Carbon Steel)** for cutting softer materials such as wood or plastics.
- **HSS (High Speed Steel)** for cutting harder materials such as metals.
- **BiM (Bi-metal, HCS base and HSS teeth)** for cutting soft materials to hard materials such as wood, metal, plastics.
- **TC (Tungsten Carbide)** for cutting glass fiber reinforced plastic, cement-bonded fiberboards or plasterboard.

# Jigsaw / Reciprosawing

## Makita type Jig Saw blade



For Model:  
4300BA/BV, 4326M, 4327M

Shape	No.	Wood Plywood (mm)	Plastics (mm)	Aluminum (mm)	Stainless Steel (mm)	Mild Steel (mm)	Features / Application	Working Length (mm)	Tooth Per Inch	Material	Type of cutting	Per pkg.	Part No.
-------	-----	-------------------	---------------	---------------	----------------------	-----------------	------------------------	---------------------	----------------	----------	-----------------	----------	----------









### Wood/ Basic

	3	3-50	3-50	-	-	-	For general cutting	60	9	HCS		5	A-85868
	16	3-50	3-50	-	-	-	For scroll cutting	60	9	HCS		5	A-85830







### Wood/ Fast

	8	4-50	4-50	-	-	-	For fast cutting	60	8	HCS		5	A-85911
---	---	------	------	---	---	---	------------------	----	---	-----	---	---	---------





### Wood/ Finish

	9	4-50	4-50	-	-	-	For fast finish work	60	8	HCS		5	A-85927
	10	4-50	4-50	-	-	-	For fast finish work, especially suitable for plywood	60	9	HCS		5	A-85818
	10S	3-50	-	-	-	-	Splinter-free cuts in wood, requiring no sanding	62	13	HCS		5	A-85824
	BR-3	4-50	-	-	-	-	Splinter-free cuts in wood requiring no sanding	60	9	HCS		5	A-85933





### Hardwood / Decorative veneers

	2	3-50	3-50	2-6	-	2-6	For decorative veneers.	60	14	HSS		5	A-85852
	4	3-50	3-50	3-6	-	3-6	For hardwood, thick mild steel plate and tough plastics	60	9	HSS		5	A-85874
	17	2-50	2-50	2-6	-	2-6	Ideal for scroll cutting of decorative veneer	63	14	HSS		5	A-85846

### Finish for decorative veneers

	41	3-50	3-50	-	-	-	Reverse tooth for splinter-free cuts. for tough plastic and decorative veneers	60	12	HCS		5	A-85880
	42	2-50	2-50	-	-	-	For decorative veneer	60	16	HSS		5	A-85896

### Metal/ Basic

	1	-	1-6	1-3	0.5-3	1-3	For mild steel. Also suitable for corrugated plastics and tough plastics	60	24	HSS		5	A-85802
	5	-	1.5-6	1-6	-	1-3	For mild steel	42	24	HSS		5	A-85905

# Jigsaw / Reciprosawing

## Bayonet type Jig Saw blade

For Model:

DJV181, DJV182, DJV180, JV183D, JV143D, JV0600, JV100D, JV101D, JV102D, JV103D, JV141D, JV142D  
DJR185, JR102D, JR105D, 4326, 4327, 4328, 4329, 4350T/CT/FCT, 4351T/CT/FCT



Shape	No.	Wood Plywood (mm)	Plastics (mm)	Aluminum (mm)	Stainless Steel (mm)	Mild Steel (mm)	Features / Application	Working Length (mm)	Tooth Per Inch	Material	Type of cutting	Per pkg.	Part No.
-------	-----	-------------------	---------------	---------------	----------------------	-----------------	------------------------	---------------------	----------------	----------	-----------------	----------	----------

### Super Express Jig saw Blade

	B-50	5-50	5-50	-	-	-	For fast finish work in wood and plastic	77	8.5-10.6	HCS	↑	5	B-06460
	B-51	-	-	-	1-3	1-8	Fast cut for mild steel, stainless steel	77	9.8-18.1	HSS	↑	5	B-06476
	B-52	5-50	5-50	3-35	3-5	3-8	Fast cut for universal materials	77	5.5-9.8	HSS	↑	5	B-06482

### Wood/ Basic

	B-13	4-65	4-65	-	-	-	For general cutting	70	8	HCS	↑	5	A-85656
	B-15	3-35	3-35	-	-	-	Ideal for cutting thin materials	50	12	HCS	↑	5	A-85678
	B-14	2-35	2-35	-	-	-	Ideal for cutting thin materials	50	18	HCS	↑	5	A-85662
	B-18	2-35	2-35	-	-	-	For scroll cutting	45	14	HCS	↻	5	A-85709

























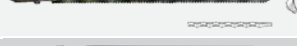

### Wood/ Fast

	B-58	4-65	4-65	-	-	-	For fast cutting	75	8	HCS	↑	5	A-86577
	B-16	5-65	5-65	-	-	-	For fast and rough cutting	75	6	HCS	↑	5	A-85684
	L-2	5-90	5-90	-	-	-	For fast and rough cutting	100	6	HCS	↑	5	A-86309
	B-16L	5-135	5-135	-	-	-	For fast and rough cutting	150	6	HCS	↑	5	792726-5
	B-17	5-60	5-60	-	-	-	For fast and scroll cutting	70	6	HCS	↻	5	A-85690
	B-8	4-65	4-65	-	-	-	Hook angle: 2 degrees	75	8	HCS	↑	5	A-85232

### Wood/ Finish

	B-59	4-65	4-65	-	-	-	For fast finish work	75	8	HCS	↑	5	A-86583
	B-10	3-65	3-65	-	-	-	For fast finish work, especially suitable for plywood	75	9	HCS	↑	5	A-85628
	B-11	3-60	3-60	-	-	-	For fast finish work in wood and plastics	75	9	HCS	↑	5	A-85634
	B-10S	3-50	-	-	-	-	Splinter-free cuts in wood requiring no sanding	65	13	HCS	↑	5	792691-8
	B-12	5-65	5-65	-	-	-	For fast finish work in wood and plastics	75	6	HCS	↑	5	A-85640
	L-1	5-90	5-90	-	-	-	Ideal for cutting thick materials	100	6	HCS	↑	5	A-86290
	B-29	2-35	2-35	-	-	-	For scroll cutting	42	16	HCS	↻	5	A-80400
	BR-13	5-65	-	-	-	-	Splinter-free cuts in wood, requiring no sanding	64	9	HCS	↑	5	A-85793









# Jigsaw / Reciprosawing

Shape	No.	Wood Plywood (mm)	Plastics (mm)	Aluminum (mm)	Stainless Steel (mm)	Mild Steel (mm)	Features / Application	Working Length (mm)	Tooth Per Inch	Material	Type of cutting	Per pkg.	Part No.
<b>Hardwood / Hard Plastic</b>													
	B-26	3-60	3-60	3-10	-	3-10	For scroll cutting in hardwoods and for hard plastics.	70	9	HSS		5	A-85771
	B-19	3-50	3-50	-	-	-	Reverse tooth for splinter-free cuts. For tough plastics and decorative veneers	65	12	HCS		5	A-85715
	B-53	3-50	3-50	-	-	-	Splinter-free cuts in laminate and plastics.	82	15	Bi-Metal		5	B-10970
	B-54	3-50	3-50	-	-	-	Splinter-free cuts in laminate and plastics.	82	18	Bi-Metal		5	B-10986
<b>Metal/ Basic</b>													
	51	-	1.5-6	1.5-6	1-3	1-3	For mild steel	65	24	HSS		5	A-86561
	B-22	-	1-6	1-3	1-3	1-3	For mild steel, tough plastics. Especially for thin metal plate	50	24	HSS		2 5	B-01323 A-85737
	B-24	-	1-3	1-2	0.5-2	0.5-2	For very thin metal plate	50	32	HSS		5	A-85759
	B-23	3-35	3-35	2-6	-	2-6	For decorative veneers, medium-thick metal plate	50	14	HSS		5	A-85743
	B-27	-	1-6	1-3	1-3	1-3	For scroll cutting in mild steel	50	24	HSS		5	A-85787
	B-32	-	-Ø65	-Ø65	-	1.5-3	For thin metal plate, pipes and profiles. Also Aluminum and plastics.	107	18	HSS		5	B-10431
	B-34	-	1.5-6	1.5-3	1.5-3	1.5-3	For mild steel, tough plastics. Especially for thin metal plate	50	18	HSS		5	B-10453
	B-35	*	-Ø114	2-6	-	-	For sandwich materials * Wood with nails -ø120	154	14	Bi-Metal		5	B-10469
<b>For Rubber</b>													
	B-K	-	-	-	-	-	Ideal for cutting of paper, cork, rubber, leather	75	-	HCS	-	5	A-80416
<b>For Fiber Cement</b>													
	B-60	-	-	-	-	-	Fiber Cement/Plaster Board 5-50, FRP/Plastic 5-20	75	6	TC/HM	-	3	B-06890
	B-61	-	-	-	-	-	Fiber Cement/Plaster Board 5-80, FRP/Plastic 5-50	105	6	TC/HM	-	3	B-06909

## Economy type Jig Saw blade

For Model:

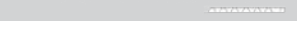
DJV181, DJV182, DJV180, JV183D, JV0600, JV100D, JV101D, JV102D, JV103D, JV141D, JV142D, DJR185, JR102D, JR105D, 4326, 4327, 4328, 4329, 4350T/CT/FCT, 4351T/CT/FCT

Shape	Wood Plywood (mm)	Plastics (mm)	Aluminum (mm)	Stainless Steel (mm)	Mild Steel (mm)	Features / Application	Working Length (mm)	Tooth Per Inch	Material	Type of cutting	Per pkg.	Part No.
	4-50	-	-	-	-	Wood / Basic	74	8	HCS		5	D-34877
	4-50	-	-	-	-	Wood / Fast	74	6	HCS		5	D-34883
	4-50	-	-	-	-	Wood / Fast, Curved	74	6	HCS		5	D-34899
	4-50	-	-	-	-	Wood / Finish	74	9	HCS		5	D-72718

# Jigsaw / Reciprosawing

## Jig Saw Blade 100pc/ pack

Type	No.	Application	Part No.
Makita type	No.1	Metal	B-07783



## Jig Saw blade assortment

\*Super Express Jig saw blade



Type	Five different jig saw blades in one packet					Part No.
Makita type	No.1	No.2	No.3	No.8	No.10S	A-86882
B type	B-10S	B-13	B-16	B-22	B-23	A-86898
B type	B-50	B-51	B-52	-	-	*B-06292

## Recipro saw blades for Model JR1000FT, JR102D





HCS / High carbon steel for cutting softer materials such as wood or plastics HSS / High speed steel for cutting harder materials such as metals, Aluminum, and non-metals  
For Cutting

Shape	No.	Wood Plywood (mm)	Plastics (mm)	Aluminum (mm)	Stainless Steel (mm)	Mild Steel (mm)	Features / Application	Working Length	Tooth Per Inch	Material	Type of cutting	Per pkg.	Part No.
-------	-----	-------------------	---------------	---------------	----------------------	-----------------	------------------------	----------------	----------------	----------	-----------------	----------	----------





### Wood/ Fast

	B-8	4-65	4-65	-	-	-	Ideal for fast cutting of wood and plastics. Hook angle: 2 degrees	75	8	HCS		5	A-85232
---	-----	------	------	---	---	---	--	----	---	-----	---	---	---------



### Wood/ Finish

	B-10	3-65	3-65	-	-	-	For fast finish work, especially in plywood.	75	9	HCS		5	A-85628
	B-37	3-65	3-65	-	-	-	B shank wood finish, for scroll cutting	80	9	HCS		5	E-22218

### Finish for decorative veneers

	B-19	3-50	3-50	-	-	-	Reverse tooth for splinter-free cuts. For tough plastics and decorative veneers	65	12	HCS		5	A-85715
	B-19S	3-25	3-25	-	-	-	Short type of B-19	43	12	HCS		5	B-04933



### Metal/ Basic

	B-22	-	1-6	1-3	1-3	1-3	For mild steel, tough plastics. Especially for thin metal plate	50	24	HSS		2	B-01323
---	------	---	-----	-----	-----	-----	---	----	----	-----	---	---	---------

### Metal/ Thin cutting

	B-24	-	1-3	1-2	0.5-2	0.5-2	For very thin metal plate	50	32	HSS		5	A-85759
---	------	---	-----	-----	-------	-------	---------------------------	----	----	-----	---	---	---------

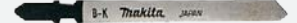
### For Paper, Cork, Rubber, Leather



Shape	No.	Foam polystyrene	Card board	Rubber	Leather	-	Features / Application	Working Length (mm)	Tooth Per Inch	Material	Type of cutting	Per pkg.	Part No.
	B-K	50	30	10	5	-	Ideal for cutting of paper, cork, rubber and leather.	75	-	HCS		5	A-80416

# Jigsaw / Reciprosawing













## Recipro saw blade

Type	Teeth per inch	Overall length (mm)	Blade thickness (mm)	Application	Tooth Material	Per pkg.	Part No.
------	----------------	---------------------	----------------------	-------------	----------------	----------	----------



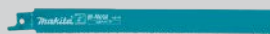

### Super Express Recipro saw Blade

	7-18	152	0.9	Fast cut for metal (Iron/steel 1.5-8.0mm, Plastic 5-77mm)	Bi-Metal	5	B-05038
	6-11	152	0.9	Fast cut for non-ferrous metal, aluminum, plastics, wood with nail, steel (Iron/steel 5-8mm, Plastic 5-77mm, Wood 5-77mm)	Bi-Metal	5	B-05044
	6-10	203	1.0	Fast cut for wood	HCS	5	B-05153

### For Metal / Basic





No.24 	24	165	1.0	For steel plate 1.5mm-3.0 mm. For iron pipe 90 mm dia. or less.	HSS	5	792149-7
	14	152	0.9	metal plate 3-8mm pipe 10-100mm	Bi-Metal	5	B-16841
	14	150	1.8	---	Bi-Metal	2	D-80298
	14	225	0.9	metal plate 3-8mm pipe 10-175mm	Bi-Metal	5	B-16776
	14	225	1.8	---	Bi-Metal	2	D-80307
	18	152	0.9	For thin metal 1.5-4.0mm. For iron pipe 100mm dia or less.	Bi-Metal	5	B-05169
	18	150	1.4	---	Bi-Metal	2	D-80313
	18	225	0.9	metal plate 1.5-4mm pipe 5-175mm	Bi-Metal	5	B-16782
	18	225	1.4	---	Bi-Metal	2	D-80329
	24	152	0.9	metal plate 0.7-3mm pipe 5-100mm	Bi-Metal	5	B-16835
	24	150	1.0	---	Bi-Metal	2	D-80335
	24	225	0.9	metal plate 0.7-3mm pipe 5-175mm	Bi-Metal	5	B-43169
	24	225	1.0	---	Bi-Metal	2	D-80341
	10-14	305	0.9	metal tubing 5-200mm, Aluminum & plastic 5-20mm	Bi-Metal	5	B-16857

### For Metal / Heavy

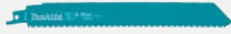

	14+18	152	1.1	metal plate 3-8mm, pipe <100mm	Bi-Metal	5	B-43131
	14+18	225	1.1	metal plate 3-8mm, pipe <175mm	Bi-Metal	5	B-43175
	14+18	305	1.1	metal plate 3-8mm, pipe <250mm	Bi-Metal	5	B-43206
	8+10	152	1.1	thick sheet metal 4-12mm, pipe <100mm (fast cut)	Bi-Metal	5	B-43147



# Jigsaw / Reciprosawing

Type	Teeth per inch	Overall length (mm)	Blade thickness (mm)	Application	Tooth Material	Per pkg.	Part No.
	8+10	225	1.1	thick sheet metal 4-12mm, pipe <175mm (fast cut)	Bi-Metal	5	B-43181
	8+10	305	1.1	thick sheet metal 4-12mm, pipe <250mm (fast cut)	Bi-Metal	5	B-43212
	10-14	152	1.25	thick sheet metal 2-10mm, pipe <100mm (fine cut)	Bi-Metal	5	B-43153
	10-14	225	1.25	thick sheet metal 2-10mm, pipe <175mm (fine cut)	Bi-Metal	5	B-43197
	10-14	305	1.25	thick sheet metal 2-10mm, pipe <250mm (fine cut)	Bi-Metal	5	B-43228

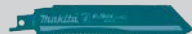
## For Metal / Heavy / Curve shape

	14+18	152	1.1	metal plate 3-8mm, pipe <100mm	Bi-Metal	5	B-55815
	14+18	225	1.1	metal plate 3-8mm, pipe <175mm	Bi-Metal	5	B-55821
	14+18	305	1.1	metal plate 3-8mm, pipe <225mm	Bi-Metal	5	B-55837

## TC Reciprosaw Blade





### Tungsten Carbide Tip





### Application





## For Metal / Heavy / TC

	8	100	1.25	thick sheet metal 4-12mm, pipe <50mm	TC/HM	1	B-55566
	8	152	1.25	thick sheet metal 4-12mm, pipe <100mm	TC/HM	1	B-55572
	8	228	1.25	thick sheet metal 4-12mm, pipe <175mm	TC/HM	1	B-55588
	8	305	1.25	thick sheet metal 4-12mm, pipe <250mm	TC/HM	1	B-55594

## For Wood / Basic

No.3020 	10	150	1.0	For wood, plywood 5mm-90mm	HCS	5	A-02319
	10	152	0.8	soft wood, chipboard, wood core plywood <100mm	HCS	5	B-16807
No.3023 	10	250	1.25	For thick wood 5mm-190mm	HCS	5	B-00767

## For Wood / Fast

No.23B 	6	150	1.0	For fast finish work in wood 10mm-90mm	HCS	5	792707-9
No.3019 	4	150	1.0	For fast and rough cutting in thick wood. 20mm-90mm	HCS	5	A-02303
No.3030 	6	300	1.25	For roughing work on thick wood. 10mm-250mm	HCS	5	B-03030

# Jigsaw / Reciprosawing

Type	Teeth per inch	Overall length (mm)	Blade thickness (mm)	Application	Tooth Material	Per pkg.	Part No.
------	----------------	---------------------	----------------------	-------------	----------------	----------	----------

## Japanese Teeth Reciprosaw Blade

### 1. Japanese teeth for Sharp Edge!

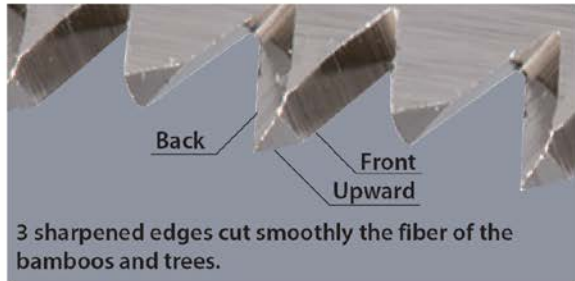

### 2. Clean Cutting Surface

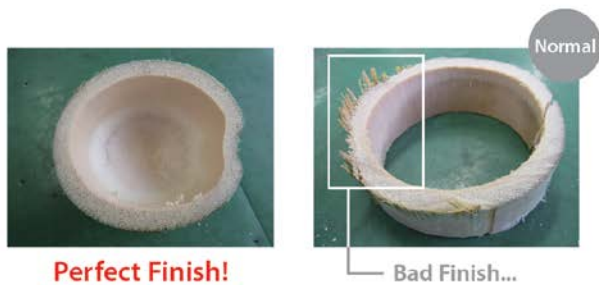

### Application

#### For Bamboo

15TPI



#### For Green Wood

8.5TPI



### for Wood / Clean cut

	8.5	190	0.6	For planting green wood <math>\phi</math>100mm, wood <math>< 100\text{mm}</math>	HCS	1	B-56580
	15	190	0.6	For bamboo <math>< \phi 100\text{mm}</math>, wood <math>< 100\text{mm}</math>, PVC <math>< \phi 100\text{mm}</math>	HCS	1	B-56596
	8.5	225	0.9	For planting green wood <math>< \phi 140\text{mm}</math>, wood <math>< 140\text{mm}</math>	Bi-Metal	1	B-57386
	15	225	0.9	For bamboo <math>< \phi 140\text{mm}</math>, wood <math>< 140\text{mm}</math>, PVC <math>< \phi 140\text{mm}</math>	Bi-Metal	1	B-57392

### for Wood and Metal



\*White Lacquered, \*\*Unlacquered

	6	152	1.25	For wood with nails 10mm-100mm, Glass Fiber 8-50mm	Bi-Metal	5	B-05175
	10	152	0.9	For pallets, wood with nails 5-100mm sheet metal, pipes, aluminum profiles 3-12mm	Bi-Metal	5	B-31843
	10	228	0.9	For pallets, wood with nails 5-175mm sheet metal, pipes, aluminum profiles 3-12mm	Bi-Metal	5	B-31859
	5-8	305	1.25	Wood with nails/metal, chipboards (10-250mm), aerated concrete (10-250mm), plastics/Glass fibre reinforced plastics, profiles (5-60mm)	Bi-Metal	3	B-10637
	10-14	152	0.9	wood with metal 5-100mm, aluminum 3-10mm, plastic 3-100mm	Bi-Metal	5	B-43240
	10-14	225	0.9	wood with metal 5-175mm, aluminum 3-10mm, plastic 3-175mm	Bi-Metal	5	B-43262



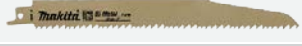

# Jigsaw / Reciprosawing

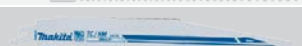
Type	Teeth per inch	Overall length (mm)	Blade thickness (mm)	Application	Tooth Material	Per pkg.	Part No.
------	----------------	---------------------	----------------------	-------------	----------------	----------	----------



## For Wood and Metal / Heavy

	5-8	152	1.6	wood with metal, chipboard 10-100mm	Bi-Metal	5	B-43234
	5-8	225	1.6	wood with metal, chipboard 10-175mm	Bi-Metal	5	B-43256
	5-8	305	1.6	wood with metal, chipboard 10-235mm	Bi-Metal	5	B-43278
	6-8	152	1.25	Wood with nails/metal, chipboards (5-100mm), plastics/Glass fibre reinforced plastics (<100mm)	TC/HM	1	B-49834
	6-8	228	1.25	Wood with nails/metal, chipboards (5-175mm), plastics/Glass fibre reinforced plastics (<175mm)	TC/HM	1	B-49840
	6-8	305	1.25	Wood with nails/metal, chipboards (5-250mm), plastics/Glass fibre reinforced plastics (<250mm)	TC/HM	1	B-49856

## For Special Purpose

	-	225	1.5	Insulation Material, Glass Wool, Stone Wool (10-175mm)	HCS	2	B-52118
	-	300	1.5	Insulation Material, Glass Wool, Stone Wool (10-250mm)	HCS	2	B-52124
	-	400	1.5	Insulation Material, Glass Wool, Stone Wool (10-300mm)	HCS	1	B-52130
	18	152	1.0	For stainless steel plate 2mm-4mm, stainless steel pipe 80mm dia or less, fiber glass	TC/HM	2	B-07250
	-	225	1.0	Cast-steel pipe 150mm dia or less, for red brick 10-175mm, FRP/Epoxy 3-175mm	Diamond Grit	2	B-31871

## For wood and metal/rescue

	6-8	152	1.25	Wood, Chipboard, Wood with nails, Metal, Plastics, FRP	Milled and wavy set teeth	25	B-67206
	6-8	225	1.25	Wood, Chipboard, Wood with nails, Metal, Plastics, FRP	Milled and wavy set teeth	25	B-67212

## For Ice/Frozen Material





	3	305	1.25	For Ice 10-250 mm	Stainless Steel	1	B-10609
	6	228	1.2	For Ice 10-175 mm	Stainless Steel	1	B-30564
	10	228	1.2	For Ice 10-175 mm	Stainless Steel	1	B-30570

## Economy type Recipro saw blade

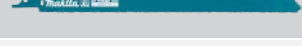

Type	Teeth per inch	Overall length (mm)	Blade thickness (mm)	Application	Tooth Material	Per pkg.	Part No.
------	----------------	---------------------	----------------------	-------------	----------------	----------	----------

## For Metal

	18	152	0.9	metal plate 1.5-4mm pipe 5-100mm	Bi-Metal	2	D-51633
	18	225	0.9	metal plate 1.5-4mm pipe 5-175mm	Bi-Metal	2	D-51661
	24	152	0.9	metal plate 0.7-3mm pipe 5-100mm	Bi-Metal	2	D-51649
	24	225	0.9	metal plate 0.7-3mm pipe 5-175mm	Bi-Metal	2	D-51677

# Jigsaw / Reciprosawing

## Board Cutter Blade



**For Model:**  
DSD140, DSD180, SD100D

Blade length (mm)	Blade width (mm)	Blade thickness (mm)	Application	Tooth Material	Per pkg.	Part No.
55	18	0.55	Plasterboard (<30mm)	HCS	2	B-49703
55	18	0.55	Wood (<30mm)	HCS	2	B-49719

## Scroll Saw Blade

**For model: SJ401**

Application	No of teeth per inch	Pc per pkg.	Part No.
Straight line and large curve on wood	60	5	A-31099
Optimal switching curve and small area on wood	70	5	A-31108

5"  
127mm



## Band Saw Blade

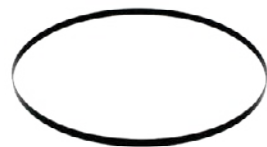

**Teeth shape (Image)**

Wave teeth



Raker teeth



Model No.	Type	Width (mm)	No. of teeth per inch	Teeth shape	Application	Part No.
-----------	------	------------	-----------------------	-------------	-------------	----------

**Width : 13 mm, Thickness : 0.5 mm, Length : 730 mm**

DPB184	Bi-Metal (5pc.)	More than 5 mm	14		Plastics and non-ferrous metal. Mild steel, cast steel and cast iron. Hard steel and stainless steel.	E-04101
		4 mm- 5 mm	18			E-04117
		Less than 4 mm	24			E-04123

**Width : 13 mm, Thickness : 0.5 mm, Length : 835 mm**

DPB181 DPB182	Bi-Metal (5pc.)	More than 5 mm	14		Plastics and non-ferrous metal. Mild steel, cast steel and cast iron. Hard steel and stainless steel.	B-40543
		4 mm- 5 mm	18			B-40559
		Less than 4 mm	24			B-40565

**Width : 13 mm, Thickness : 0.5 mm, Length : 1,140 mm**

DPB180, 2107F, 2107FW	Carbon steel (3pcs./set)	More than 5 mm	14		Plastics and non-ferrous metal. Mild steel, cast steel and cast iron.	792560-3
		4 mm- 5 mm	18			792559-8
		Less than 4 mm	24			792558-0
	Bi-Metal (1pc.)	More than 5 mm	10		Plastics and non-ferrous metal. Mild steel, cast steel and cast iron. Hard steel and stainless steel.	B-30128
		More than 5 mm	14			792557-2
		4 mm- 5 mm	18			792556-4
		Less than 4 mm	24			194692-6

**Thickness : 0.5 mm, Length : 2,240 mm**

LB1200F	Carbon steel (3pcs./set)	16	4		Wood/ for cross-cut	B-16667
		13	4		Wood/ for universal	B-16673
		6	6		Wood/ for curve-cut	B-16689
		16	14		Nonferrous metal	B-16695

# ACCESSORIES

## ▣ Brushing



Metal, mild steel



Wood



Plastic



Removing paint



Removing paint from metal or polishing



Hook and loop type



Do not drill with impact

# Brushing

## Brushes for Grinder

### Shape type

Cup Type



Effective for flat or grinded surface

Wheel Type



Effective for working at spot

Bevel Type



Effective for working at corner

### Wire brush

For Model:

A: 100mm Disc / Angle Grinder

B: 125, 150mm Angle Grinder

C: 180, 230mm Angle Grinder

D: 230mm Angle Grinder

### Wire Cup brush, Crimped wire

0.3mm crimped steel wire  
(Ideal for light rust removal  
from flat surfaces and edges.)



For Model	Size	Spindle thread	Part No.
A	60mm	M10 x 1.5	D-24066
B	60mm	M14 x 2	D-24072
A	75mm	M10 x 1.5	D-24088
C	100mm	M14 x 2	D-29284

### Wire Cup brush, Crimped wire, brass-coated

0.3mm Brass coated steel wire  
(Ideal for light rust removal.  
Prevented from wire corrosion.)



For Model	Size	Spindle thread	Part No.
C	90mm	M14 x 2	D-39780

### Wire Cup brush, Knotted wire

0.5mm knotted steel wire1  
(Ideal for heavy work  
for fast cleaning of large surface.)



For Model	Size	Spindle thread	Part No.
A	60mm	M10 x 1.5	D-24103
A	75mm	M10 x 1.5	D-24125

### Wire Cup brush, Knotted wire 2

0.5mm knotted steel wire2  
(Ideal for especially heavy work.)



For Model	Size	Spindle thread	Part No.
A	60mm	M10 x 1.5	D-24147
C	100mm	M14 x 2	D-29290

### Wire wheel brush, Crimped wire



For Model	Size	Spindle thread	Part No.
A	100mm	M10 x 1.5	D-77506

### Wire brush, bevel/ crimped



For Model	Size	Spindle thread	Part No.
A	100mm	M10 x 1.5	D-77556

### Wire brush, bevel/ knotted



For Model	Size	Spindle thread	Part No.
A	100mm	M10 x 1.5	D-77578

### Wire wheel brush, Knotted wire

0.5mm knotted steel wire  
(Effective for heavy duty cleaning at spot.)



For Model	Size	Spindle thread	Part No.
A	100mm	M10 x 1.5	D-77528
B, C	100mm	M14 x 2	D-29555
B, C	115mm	M14 x 2	D-29561
B, C	125mm	M14 x 2	D-29577
D	175mm	M14 x 2	D-45777

### Slit paper wheel 120-40

(For rust and paint removal)

For Model:  
9741



Part No.
794380-1

### Nylon brush wheel

For Model:  
9741



Application	Part No.
120-80 Coarse	794384-3

### Nylon brush set for drill - 3 pcs

For driver drill.

Diameter for cup brush: 50mm, wheel brush: 50mm and end brush: 24mm



Description	Part No.
Coarse Grit 80	D-70742
Fine Grit 240	D-70758

# ACCESSORIES

## ▣ Bonded Abrasive



Metal, mild steel



Stainless steel



Aluminum



Metal stud



Plaster mortar



Flexible



Always use  
back up pad



Fast cut



Smooth disc  
surface

# Bonded Abrasive

## New Label design



Lot number and validity : on washer (If there is not on washer, there is on label)

### Point 1 The icon tell that how to use.

	for metal	for INOX	for Masonry	for Aluminum
Grinding				
Cutting for grinder				
Cutting for portable cut-off			—	
Cutting for power cutter		—		—



# Bonded Abrasive

## Point 2 The marks tell the range in makita.

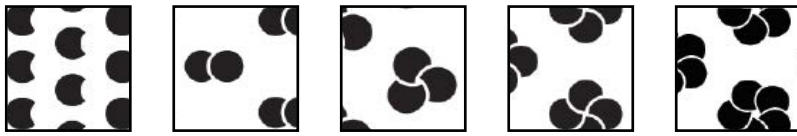

performance more good

## Point 3 How to read the spec.

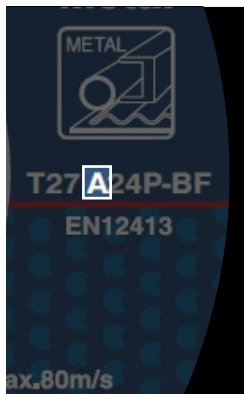

### Aluminum Oxide Group ( mainly for metal & INOX )

#### Brown Fused Aluminum: A

The most common abrasive material for metal.



#### Single Aluminum Oxide: SA

Single crystal abrasive material with high tenacity. Higher durability and grinding/cutting performance than A.



#### White Aluminum Oxide: WA

High purity abrasive material, eliminated extraneous elements from A. Higher grinding and cutting performance than A.



#### Alumina Zirconium: Z

Extremely sharp and hard abrasive material. Grinding/cutting performance than SA.



#### Ceramic:



Extremely sharp and high resistant to shock/heat/wear. High grade abrasive material with excellent grinding performance and durability.

### Silicon Oxide Group (mainly for non-metallic)

#### Black Silicon Carbide: C

The most common abrasive material for non-metal.



#### Green Silicon Carbide: GC

Higher purity than C, eliminated extraneous elements, thus having higher grinding and cutting performance than C, but a little lower durability than C.

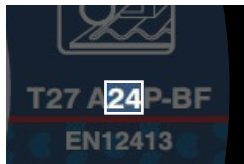

### Grit Size

24

36

60

80

120

Coarse



Fine

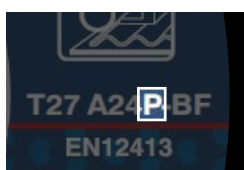

### Hardness of grinding wheel

Closer to A, softer grinding wheel is  
Closer to Z, harder grinding wheel is

Soft grinding wheel ▶ Hard work piece

Hard grinding wheel ▶ Soft work piece

Very Soft	Soft	Middle	Hard	Very Hard
A - G	H - K	L - O	P - S	T - Z

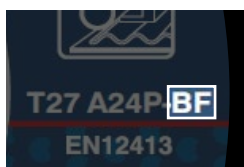

### Type of Bond

BF : Reinforced resinoid bond  
V : Vitrified bond

## Point 4 The color tell the application.

	for metal	for INOX	for Masonry	for Aluminum
color	 Blue	 Orange	 Green	 Gray

# Bonded Abrasive

## Grinding wheel/ Metal/ Depressed



Three-star range

★★★

Size (mm)	Grit	Per pkg	Part No.
100 x 6 x 16	A36P	1	A-80911(EN)
125 x 6 x 22.23	A36P	1	A-80933(EN)
150 x 6 x 22.23	A36P	1	A-84981(EN)
230 x 6 x 22.23	A36P	1	A-80955(EN)

Two-star range

★★

Size (mm)	Grit	Per pkg	Part No.
125 x 6 x 22.23	A24R	1	D-18465(EN)
180 x 6 x 22.23	A24R	1	D-18471(EN)
230 x 6 x 22.23	A24R	1	D-18487(EN)

One-star range

★

Size (mm)	Grit	Per pkg	Part No.
100 x 6 x 16	A24P	1	D-72241(EN)

## Grinding wheel/ Metal/ Depressed with X-LOCK



# X-LOCK

Grinding wheel/ Metal

Size (mm)	Grit	Per pkg	Part No.
100 x 6 x 22.23	A36P	1	E-00480(EN)

Grinding wheel/ Stainless

Size (mm)	Grit	Per pkg	Part No.
100 x 6 x 22.23	WA36N	1	E-00496(EN)

Thin Cut-off wheel (Flat)

Size (mm)	Grit	Per pkg	Part No.
100 x 1.2 x 22.23	A60T	1	E-00505(EN)
125 x 1.2 x 22.23	A60T	1	E-00418(EN)

## Grinding wheel/ Stainless/ Depressed



Three-star range

★★★

Size (mm)	Grit	Per pkg	Part No.
100 x 6 x 16	WA36N	1	A-80852(EN)
180 x 6 x 22.23	WA36O	1	A-80880(EN)
230 x 6 x 22.23	WA36O	1	A-80896(EN)



# Bonded Abrasive

## Flexible grinding wheel/ Metal



1. Less noise
2. Low vibration
3. As flexible grinding wheel cause almost no tapping, it provides excellent workability
4. Wide range of Applications



Three-star range  
★★★

Size (mm)	Grit	Per pkg	Part No.
100 x 3 x 16	AC60	1	B-18253(EN)

# Bonded Abrasive



Size (mm)	Per pkg	Part No.
for 100mm	1	B-20476
for 180mm	1	B-20498

**Flexible grinding wheel ideal for cordless angle grinder**



1. Amount of grinding per 1 charged 70% up than grinding wheel/ stainless.
2. Vibration 60% off than grinding wheel/ stainless.



Needless to use Back up pad

Four-star range  
★★★★

Size (mm)	Grit	Per pkg	Part No.
100 × 4.0 × 16	WA36P	1	B-52392(EN)

# Bonded Abrasive

## Ultra thin cut-off wheel/ Stainless/ Flat/ Ideal for Cordless angle grinder



1. Cutting speed 40% up than 1.0mm cutting.
2. Number of cut with 1 charge 20% up than 1.0mm cutting.
3. Less burr of materials



4. Less dust of materials



Four-star range  
★★★★

Type A: Flat wheel

Type B: Depressed center wheel

Size (mm)	Grit	Type	Per pkg	Part No.
100 x 0.8 x 16	Z60V	A	1	E-22931 (EN)
100 x 0.8 x 16	Z60U	A	1	E-10855 (EN)
125 x 0.8 x 22.23	Z60U	A	1	E-10877 (EN)

## Cut-off wheel for Portable cut-off/ Metal stud/ Ideal for Cordless Portable cut-off



Specialize

Size (mm)	Grit	Rough or Smooth	G.F. Q'ty	Per pkg	Part No.
355 x 4.3 x 25.4	A24T	-	2.0G	5	E-12790 (EN)
355 x 2.5 x 25.4	A36P	-	2.0G	5	B-64696 (EN)

## Thin cut-off wheel/ Stainless/ Flat



Four-star range  
★★★★

Size (mm)	Grit	Type	Per pkg	Part No.
100 x 1.0 x 16	A60V	A	1	E-17108 (EN)

Three-star range  
★★★

Size (mm)	Grit	Type	Per pkg	Part No.
76 x 1.0 x 10	A60T	A	5	D-74815-5 (EN)
100 x 1.0 x 16	A60U	A	1	E-03028 (EN)
125 x 1.0 x 22.23	A60T	A	1	E-03040(EN)
150 x 1.6 x 22.23	A60U	A	1	E-13742(EN)
180 x 1.6 x 22.23	A60U	A	1	E-13758(EN)
230 x 1.9 x 22.23	A60T	A	1	E-13764(EN)

Size (mm)	Grit	Type	Per pkg	Part No.
-----------	------	------	---------	----------



Two-star range  
★★

100 x 1.0 x 16	WA60T	A	1	D-18758(EN)
100 x 1.0 x 16	WA46R	A	1	D-65947(EN)
125 x 1.2 x 22.23	WA60T	A	1	D-18770(EN)
125 x 1.2 x 22.23	WA60T	A	10 (Can)	D-18770-10(EN)
125 x 1.0 x 22.23	WA46R	A	1	D-65969(EN)
180 x 2 x 22.23	WA46R	A	1	D-65975(EN)

# Bonded Abrasive

## Cut-off wheel/ Metal/ Flat/ Depressed



Three-star range  
★★★

Type A: Flat wheel  
Type B: Depressed center wheel



Size (mm)	Grit	Type	Per pkg	Part No.
100 x 2.5 x 16	A30R	A	1	A-85298 (EN)
125 x 2.5 x 22.23	A30R	A	1	A-85313 (EN)
180 x 2.5 x 22.23	A30R	A	1	A-85329 (EN)

Two-star range  
★★

Size (mm)	Grit	Type	Per pkg	Part No.
100 x 3 x 16	A30S	B	1	D-18552 (EN)
150 x 2.5 x 22.23	A30S	A	1	D-29402 (EN)
180 x 3 x 22.23	A30S	B	1	D-18580 (EN)
230 x 2.5 x 22.23	A30S	A	1	D-18699 (EN)

## Grinding wheel/ Stainless/ Depressed/ 2in1/ Ideal for Cordless angle grinder



- Cutting speed 10% up than 2 in 1 wheel.
- Number of cut with 1 charge 80% up than 2 in 1 wheel.

Cutting



Deburring



Appropriate wheel cover is required

Three-star range  
★★★

Size (mm)	Grit	Per pkg	Part No.
100 x 2.2 x 16	SA46P	1	B-51649 (EN)
125 x 2.2 x 22.23	SA46P	1	B-51655 (EN)

## Grinding wheel/ Metal/ Stainless/ Depressed/ Ideal for Cordless angle grinder



3mm thickness  
One-star range  
★



Size (mm)	Grit	Per pkg	Part No.
100 x 3 x 16	A30S	1	D-79996
125 x 3 x 22.23	A30S	1	D-80014
180 x 3 x 22.23	A30S	1	D-80020

### Thin cut-off wheel for Portable cut-off/ Metal

#### 1. Thinner blade & the optimum bonding

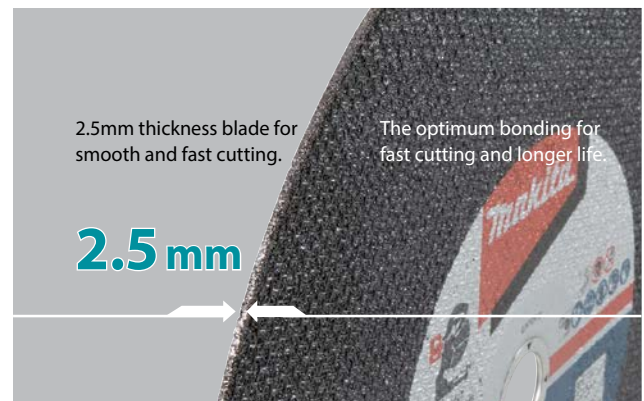

#### 2. Ideal for cordless tools

The amount of cutting per 1 charge

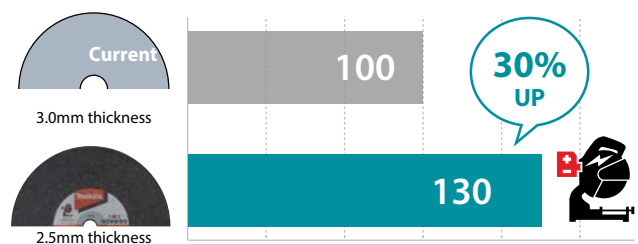

\* The test results depend to a great extent on the hardness of materials, etc.

\* The number in the bar graphs are relative values when the capacity of current wheel is indexed at 100.

Three-star range  
★★★

Size (mm)	Grit	Texture	G.F. Q'ty	Part No.
305 x 3 x 25.4	A36P	Rough	1.0G	A-88456
355 x 3 x 25.4	A36P	Smooth	1.0G	A-89545
405 x 3 x 25.4	A36P	Rough	1.0G	A-88478

Two-star range  
★★

355 x 3 x 25.4	A36T	Rough	1.0G	E-10540
----------------	------	-------	------	---------

# Bonded Abrasive

## Tungsten carbide burrs

### Cut and application

#### Standard cut

<Feature> High efficiency  
<Surface> Rough  
<Material> Metal, Stainless



#### Diamond cut

<Feature> Less vibration  
<Surface> Smooth  
<Material> Metal, Stainless



#### Non-farrous cut

<Feature> Less clogging up  
<Surface> Rough  
<Material> Non-ferrous, Plastic



### Shape and application

Shape: SA



Clean the burrs on inox



Shape: SC



Deburr of aluminium



Shape: SF



Wipe the welding line between steel plate



Shape: SL



Shape: SM



## Tungsten carbide burrs/ mm type

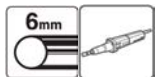

Three-star range

★★★



Shape	Grit	Bit dia. mm	Working length mm	Shank mm	Sales Pkg Qty	Part No.
SA	Diamond cut	10	20	6	1	B-52722
SC		10	20	6	1	B-52750
SF		10	20	6	1	B-52788
SL		10	25	6	1	B-52819
SM		10	20	6	1	B-52847
SA	Standard cut	10	20	6	1	B-52716
SC		10	20	6	1	B-52744
SF		10	20	6	1	B-52772
SL		10	25	6	1	B-52803
SM		10	20	6	1	B-52831
SA	Non-ferrous cut	10	20	6	1	B-52738
SC		10	20	6	1	B-52766
SF		10	20	6	1	B-52794
SL		10	25	6	1	B-52825
SM		10	20	6	1	B-52853

## Grinding wheel for Bench grinder



Size (mm)	Grit	Part No.
150 x 16 x 12.7	A36M	B-51904 (EN)
150 x 16 x 12.7	WA60K	B-51926(EN)
150 x 16 x 12.7	GC120H	B-51932 (EN)
205 x 19 x 15.88	A36P	B-51948 (EN)
205 x 19 x 15.88	A60P	B-51954 (EN)
205 x 19 x 15.88	WA60K	B-51960(EN)
205 x 19 x 15.88	GC120H	B-51976 (EN)

## Grinding wheel for Straight grinder



Size (mm)	Grit	Part No.
125 x 19 x 12.7	24P	741015-5
125 x 19 x 12.7	36P	741016-3

## Wheel Point

Application:

A: Mild steel, carbon steel, etc.

WA: Hardened and special steels.



No.	Per pkg.	Wheel dia. (mm)	Shank size (mm)	Type	Part No.
For Model: 903, 906, GD0800C, GD0810C, GD0600, BGD800, BGD801					
1	10	5	3	A	794050-2
1	10	8	3	A	794052-8
1	10	10	3	A	794053-6
2	10	5	3	WA	794054-4
2	10	6	3	WA	794055-2
3	10	10	3	A	794059-4

For Model:

906, GD0800C, GD0810C, GD0600, BGD800, BGD801

No.	Per pkg.	Wheel dia. (mm)	Shank size (mm)	Type	Part No.
1	1	19	6	WA	741614-3
1	1	19	1/4"	WA	741617-7
4	1	19	6	WA	741615-1
4	1	19	1/4"	WA	741616-9

# ACCESSORIES

## Coated Abrasive



Metal, mild steel



Stainless steel



Non-ferrous metal



Wood



Plaster mortar



Plastic



Removing paint from metal or polishing



Thread for Cordless sander polisher



No wet use by powertool



Hand sanding



Hand sanding (wet)



Long life



12100rpm



# Coated Abrasive

## New Label design



### Point 1 The icon tell that how to use.

	for metal	for INOX	for Masonry
Grinding			

### Point 2 The marks tell the range in makita.



### Point 3 Grain and Grit

#### Aluminum Oxide Group ( mainly for metal & INOX )

##### Grain

**Brown Fused Aluminum: A**  
The most common abrasive material for metal.



**Alumina Zirconium: Z**  
Extremely sharp and hard abrasive material.  
Grinding/cutting performance than SA.



#### Silicon Oxide Group (mainly for non-metallic)

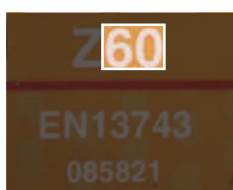
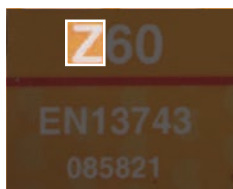

**Black Silicon Carbide: C**  
The most common abrasive material for non-metal.

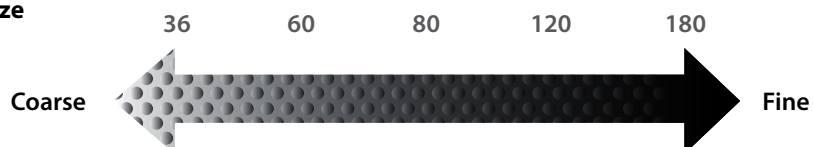

#### Grit Size



**Point 4** The color tell the application.

	for metal	for INOX	for Masonry
color	 Blue	 Orange	 Green

**Backing Type**



**Fiber glass backing**  
Standard backing type



**Nylon backing**  
For heavy duty

**Shape Type**













**Flat**  
Effective for flat surface



**Angled**  
Effective for angles or corners

**Material chart**

Recommended      Acceptable

Description of Grit material		 Aluminum oxide	 Zirconia alumina	 Silicon carbide
Description of label color		Best for metal 	Best for INOX and metal 	Best for Masonry 
Plastic		A		
Metal		AA	AA	
No ferrous		A	A	
INOX			A	
Masonry				AA

\*After reading instruction manual of grinder, please chose work material.

# Coated Abrasive

## Flap disc aluminum oxide/ Fiberglass backing/ Angled

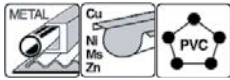

One-star range  
★

Backing Type	Backing Shape	Dia (mm)	Hole Dia (mm)	Grit	Part No.
Fiber Glass	Angled	100	16	A40	D-63395(EN)
			16	A60	D-63404(EN)
			16	A80	D-63410(EN)
			16	A120	D-63426(EN)
		125	22.23	A40	D-63476(EN)
			22.23	A60	D-63482(EN)
			22.23	A80	D-63498(EN)
			22.23	A120	D-63507(EN)
		180	22.23	A40	D-63513(EN)
			22.23	A60	D-63529(EN)
			22.23	A80	D-63535(EN)
			22.23	A120	D-63541(EN)



## Zirconia Aluminum flap disc



One-star range  
★

Backing Type	Backing Shape	Dia (mm)	Hole Dia (mm)	Grit	Part No.	
Fiber Glass	Angled	100	16	Z40	D-63703(EN)	
			16	Z60	D-63719(EN)	
			16	Z120	D-63725(EN)	
			16	Z120	D-63731(EN)	
			125	22.23	Z40	D-63781(EN)
				22.23	Z60	D-63797(EN)
				22.23	Z80	D-63806(EN)
				22.23	Z120	D-63812(EN)
				180	22.23	Z40
			22.23		Z60	D-63834(EN)
		22.23	Z80		D-63840(EN)	
		22.23	Z120		D-63856(EN)	

# Coated Abrasive

## Aluminum Flexible Flap Disc

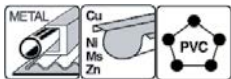

High flexibility



Suitable for grinding on CURVE/EDGE/CORNER surface.



Two-star range  
★★

Backing Type	Backing Shape	Dia (mm)	Hole Dia (mm)	Grit	Part No.
Backing Less	Flat	100	16	A40	D-62686(EN)
			16	A60	D-62692(EN)
			16	A80	D-62701(EN)
			16	A120	D-62717(EN)

## Strip disc/ Fiberglass backing



Special tool for stripping work

### Grit (SiC)

It is covered with glue with Sic (Silicon Carbide), enables you to grind quickly with less power.

### Fiber

Entangled fiber acts as a cushion material and prevents from grinding too much and scratching steel.

The surface condition of strip disc is the finest.



Removing Paint, Removing Rust, Removing blue weld discoloration



Color	Type	Speed	Life
Black	Standard	100%	100%
			

Backing Type	Dia (mm)	Hole Dia (mm)	Part No.
Fiber Glass	100	16	B-28961
	125	22.23	B-28983
	180	22.23	B-28999

# Coated Abrasive

## Surface conditioning flap disc/ Angled/ Coarse



1. Grinding and surface conditioning of metal in one step.
2. Suitable for polishing after grinding by flap disc.
3. Usable for stainless and metal.

### How to use



Removing blue weld discoloration



Removing Rust

### Polishing after grinding by flap disc

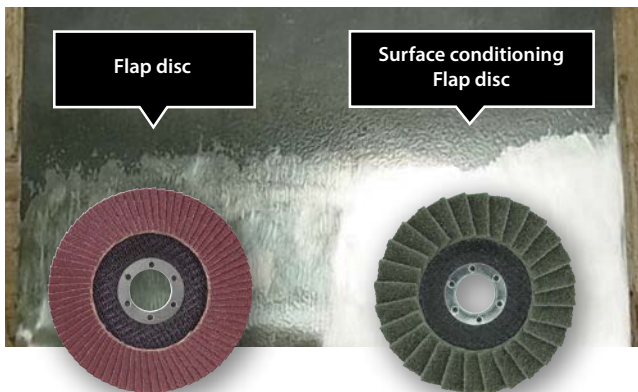

Backing Type	Backing Shape	Dia (mm)	Hole Dia (mm)	Grit	Part No.
Fiber Glass	Angled	100	16	Coarse	B-40711
			16	Medium	B-40727
			16	Fine	B-40733
			16	Very Fine	B-40749
	Flat	100	16	Coarse	B-40870
			16	Medium	B-40886
			16	Fine	B-40892
			16	Very Fine	B-40901

## Fiber sanding disc

Use with backing pad.



\*\*For Model: GV6010 only

Dia (mm)	Grit	Hole Dia (mm)	Per Pkg.	Part No.
150	**C80	12.7	10	794088-7
180	C50	22	10	794094-2 A-23818(New)
	C100	22	10	794220-3 A-23830(New)

## Net Sanding Disc & Pad Saver

Pad Saver

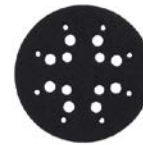

Net Sanding Disc



For Random Orbit Sander

Grit	Per Pkg.	Part No.
Pad Saver	2	D-78704
A80	10	D-78651
A120	10	D-78667
A180	10	D-78673
A240	10	D-78689
A320	10	D-78695

## Net Sanding Delta & Pad Saver

Pad Saver



Net Sanding Disc



For Orbital Sander

Grit	Per Pkg.	Part No.
Pad Saver	2	D-78944
A80	10	D-78891
A120	10	D-78900
A180	10	D-78916
A240	10	D-78922
A320	10	D-78938

# Coated Abrasive

## Accessory for 75mm Sander Polisher

### How to use

1. Use with adapter (743126-2)

2. Use with pad (743124-6)

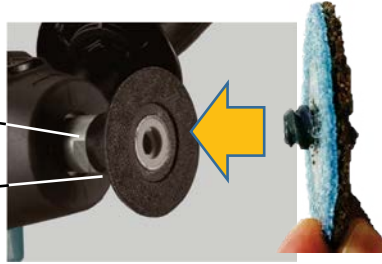

Surface conditioning disc  
For Material: Metal / Stainless, Aluminum

Dia (mm)	Type	Application	Per Pkg.	Part No.	
50	Hard	<ul style="list-style-type: none"> <li>• Surface polishing</li> <li>• Removing paint/rust</li> </ul>	Coarse	25	E-07462
			Medium	25	E-07478
			Fine	25	E-07484
	Soft	<ul style="list-style-type: none"> <li>• Surface polishing</li> </ul>	Medium	25	E-07490
			Fine	25	E-07509
			Very fine	25	E-07515

Fiber sanding disc  
For Material: Metal / Stainless, Aluminum

Dia (mm)	Grit	Application	Per Pkg.	Part No.
50	A60	<ul style="list-style-type: none"> <li>• Grinding</li> <li>• Chamfering</li> <li>• Deburring</li> <li>• Surface polishing</li> </ul>	25	E-07412
	A80		25	E-07428
	A120		25	E-07434
	Z60	<ul style="list-style-type: none"> <li>• Grinding</li> <li>• Chamfering</li> <li>• Deburring</li> </ul>	25	E-07440
	Z80		25	E-07456

## Abrasive disc

(hook & loop type)



Dia (mm)	Grit	Per Pkg.	Part No.
----------	------	----------	----------

Pre-punched (8 hole) for Wood  
For Model: BO5030, BO5031, BO5040, BO5041

Two-star range  
★★

125	A40	10	D-54134
	A60	10	D-54140
	A80	10	D-54156
	A100	10	D-54162
	A120	10	D-54178
	A180	10	D-54190
	A240	10	D-54209
	A60, A120, A240, A320	20 5pcs each	D-77229

Pre-punched (8 hole) for Paint  
For Model: BO5030, BO5031, BO5040, BO5041  
\*Additional coat: Prevents clogging



Two-star range  
★★

Dia (mm)	Grit	Per Pkg.	Part No.
125	*A40	10	D-65816
	*A60	10	D-65822
	*A80	10	D-65838
	*A100	10	D-65844
	*A120	10	D-65850
	*A150	10	D-65866
	*A180	10	D-65872
	*A240	10	D-65888
*A320	10	D-65894	
*A400	10	D-65903	

Pre-punched (9 hole) for Paint  
For Model: BO6030, BO6040  
\*Additional coat: Prevents clogging

Three-star range  
★★★

150	*WA240	10	794612-6
	*WA400	10	794613-4

Pre-punched (15 hole) for Wood  
For Model: BO6030, BO6040, BO6050



Three-star range  
★★★

150	A40	10	B-51415
	A60	10	B-51421
	A80	10	B-51437
	A100	10	B-51443
	A120	10	B-51459
	A180	10	B-51465
	A240	10	B-51471
	A320	10	B-51487
A400	10	B-51493	

Two-star range  
★★

150	A40	10	D-54586
	A60	10	D-54592
	A80	10	D-54601
	A100	10	D-54617
	A120	10	D-54623
	A150	10	D-54639
	A180	10	D-54645
	A240	10	D-54651
A320	10	D-54667	

# Coated Abrasive

## Abrasive disc/ Drywall



Three-star range  
★★★



Dia (mm)	Grit	Per Pkg.	Part No.
225	*A40	25	B-68389
	*A80	25	B-68395
	*A120	25	B-68404
	*A150	25	E-02375
	*A180	25	B-68410
	*A320	25	B-68426

For Model: 9902, 9903

Two-star range  
★★

76 x 533	A120	3	D-59302
----------	------	---	---------

For Model: 9920, 9924DB

Two-star range  
★★

76 x 610	A180	3	D-67206
----------	------	---	---------

For Model: 9401, 9402, 9403, 9404

Three-star range  
★★★

100 x 610	WA40	5	794133-8
	WA60	5	794134-6
	WA80	5	794135-4
	WA100	5	794136-2
	WA120	5	794137-0
	WA150	5	794138-8
	WA180	5	794222-9
	WA240	5	794139-6

## Abrasive Belt

For use with Belt Sander



Belt Size (mm)	Grit	Per Pkg.	Part No.
----------------	------	----------	----------

For Model: 9032, DBS180

Sanding arm Assembly

For Model: 9032

6mm: 125157-7, 9mm: 125158-5, 13mm: 125159-3

Three-star range  
★★★

6 x 533	A40	10	A-34512
	A60	10	A-34528
	A80	10	A-34534
	A100	10	A-34540
	A120	10	A-34556
9 x 533	A40	10	A-34447
	A60	10	A-34453
	A80	10	A-34469
	A120	10	A-34481
13 x 533	A40	10	A-34562
	A60	10	A-34578
	A80	10	A-34584
	A100	10	A-34590
	A120	10	A-34609

For Model: 9031

Two-star range

★★

30x533	A40	5	D-67066
	A80	5	D-67088
	A100	5	D-67094
	A120	5	D-67103
	A150	5	D-67119
	A180	5	D-67131

Two-star range  
★★

100 x 610	A40	3	D-59346
	A60	3	D-59352
	A80	3	D-59368
	A100	3	D-59374
	A120	3	D-59380
	A150	3	D-59396
	A180	3	D-59405
	A240	3	D-59411

# Coated Abrasive

## Wool pad/ Double side adapter



Model No.	Shank (mm)	Part No.
PV7001C, PV7000C, 9227C/B, 9237C/B, SA7000C	M14	D-56960

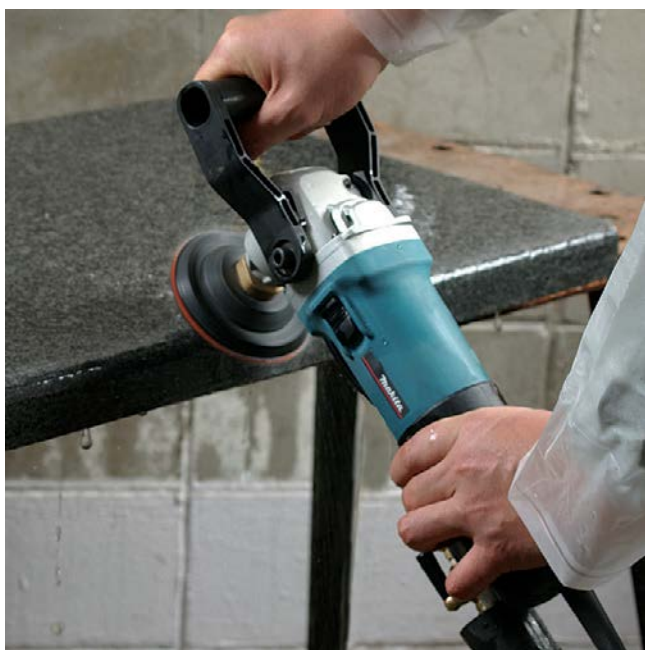

## Wool bonnet double side



Model No.	Disc Dia. (mm)	Type	Part No.
PV7001C, PV7000C, 9227C/B, 9237C/B, SA7000C	230	For Rough finishing	D-70873 (D-56954)
PV7001C, PV7000C, 9227C/B, 9237C/B, SA7000C	230	For Bright finishing	D-70889 (D-57146)

## Wool bonnet



Model No.	Disc Dia. (mm)	Part No.
PV7001C, PV7000C, 9207SPB, 9218PB/L, 9227C/B	180	794176-0

## 100mm Diamond polishing pad

(Hook & loop type)  
8 pads assortment (1 each) D-15805

For Model:  
PW5000C, PW5001C



Color	Grit	Part No.
Blue	50	D-15584
Yellow	100	D-15590
Orange	200	D-15609
Red	400	D-15615
Dark green	800	D-15621
Light green	1500	D-15637
Brown	3000	D-15643
Green	Buff (Finishing)	D-15659

## Backing pad

(Hook & loop type)  
(Use with Wool pad and Sleeve18 or Sponge pad)



Model	Spindle Thread	Part No.
9227C/B, PV7001C, PV7000C, SA7000C	M14 x 2 (DIN)	743053-3
	M16	743054-1



# Coated Abrasive

## Wool Pad

(hook & loop type)  
(For high gloss polishing)



\*When use 100mm size wool pad, use suitable pad for PO5000C

Model No.	Disc Dia. (mm)	Part No.
PV300D, PV301D	80	191N92-5
PO5000C	100	197918-5
PO5000C, DPO500	100	D-67000
PO5000C	125	197920-8
BO6030, BO6050, PO6000C, DPO600	150	D-65735
DBO180, DBO140, BO5031, BO5041	140	794560-9

(Use with Backing pad and Sleeve18)

9227C/B, 9237C/CB, PV7001/C, PV7000C	180	192629-7
--------------------------------------	-----	----------

## Sponge type

### Flat

Feature: Full contact surface  
Use: Suitable for large, flat, panel



### Wave

Feature: Air flow between the pad and the paint.  
Use: Suitable for bumper made with resin.



## Sponge pad (High repulsion)

(Hook & loop type)



## Color & Application Coarse

Color: Orange  
Use: Suitable for making wool bonnet sanding trace invisible



## Medium

Color: Blue  
Use: Suitable for finishing



## Fine

Color: Black  
Use: Suitable for Mirror finishing  
applying wax, making polishing traces invisible



For Model:

DPO500, DPO600, PO5000C, PO6000C

\*When use 100mm size sponge, use suitable pad for PO5000C

Type	Size	Application	Part No.
Flat	150mm	Coarse (Orange)	D-62527
		Medium (Blue)	D-62555
		Fine (Black)	D-62583
Wave	150mm	Coarse (Orange)	D-62614
		Medium (Blue)	D-62642
		Fine (Black)	D-62670

## Felt Pad

(hook & loop type)  
(For removing wax)



\*When use 100mm size felt pad, use suitable pad for PO5000C

Model No.	Disc Dia. (mm)	Part No.
PO5000C	100	197916-9
DBO180, DBO140, BO5031, BO5041, BO6030, BO6050, DPO500, DPO600, PO6000C	125	196152-4
	150	193288-0

## Sponge Pad

(Hook & loop type)



\*When use 100mm size sponge, use suitable pad for PO5000C

Model No.	Disc Dia. (mm)	Part No.
PV300D, PV301D	80	191N90-9
PV300D, PV301D	80	191N91-7
DBO180, DBO140, BO5031, BO5041, DPO500, PO5000C	125	794558-6
9227C/CB, 9237C/CB, PV7001/C, PV7000C	190	193470-1

## Rubber pad

Use with pre-punched abrasive disc.



Model No	Size	Type	Part No.
BO6050	150mm	Hard (For coarse sanding)	197315-5
	150mm	Soft (For general sanding)	197314-7
	150mm	Super Soft (For fine sanding)	197316-3
	130mm	Hard (For polishing)	197317-1
BO5030, BO5031, BO5040, BO5041	123mm	-	743081-8
DPO500, DPO600, PO5000C, PO6000C	100mm	-	197926-6
	125mm	-	197923-2
	150mm	-	197929-0

# ACCESSORIES

## Multi Tool



Metal, mild steel



Stainless steel



Aluminum



Wood



Wood with nails



Plywood



Tile



Limestone



Concrete block



Fiberglass



Sheet metal



Plaster board



Plastic



Epoxy



Insulation



Carpet



Silicon



Hook and loop type



Precise



Blade thickness 2.0mm



Blade thickness 3.0mm





# Multi-Tool

## Segment saw blade 85

TMA045



Feature : Suitable for Flush cutting  
Another material : Epoxy, Fiberglass

Diameter (mm)	Type	Per pkg.	Part No.
85	BiM, Wood&Metal	1	B-64799

## Segment saw blade 100

TMA046



Feature : Suitable for Deep cutting  
Another material : Epoxy, Fiberglass

Diameter (mm)	Type	Per pkg.	Part No.
100	BiM, Wood&Metal	1	B-64808

## Bow Shape plunge cut saw blade 32

TMA047



Feature : Suitable for Precisely plunge cut  
Another material : Epoxy, Fiberglass

Size (mm)	Type	Per pkg.	Part No.
32 x 50	BiM, Wood&Metal	1	B-64814

## Bow Shape plunge cut saw blade 65

TMA048



Feature : Suitable for Precisely plunge cut  
Another material : Epoxy, Fiberglass

Size (mm)	Type	Per pkg.	Part No.
65 x 40	BiM, Wood&Metal	1	B-64820

## Plunge cut saw blade 10

TMA057



Feature : Suitable for Flush cutting in nails or Plasterboard  
Another material : Epoxy, Fiberglass

Size (mm)	Type	Per pkg.	Part No.
10 x 30	BiM, Wood&Metal	1	B-64917

## Plunge cut saw blade 20

TMA058



Feature : Suitable for Flush cutting in nails or copper pipe  
Another material : Epoxy, Fiberglass

Size (mm)	Type	Per pkg.	Part No.
20 x 30	BiM, Wood&Metal	1	B-64923

## Especially suitable for Wood



## Segment saw blade 85

TMA049

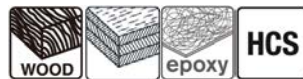

Feature : Suitable for Flush cutting  
Another material : Epoxy

Size (mm)	Type	Per pkg.	Part No.
85	HCS, Wood	1	B-64836

## Plunge cut saw blade 24

TMA050



Feature : Suitable for Plunge cut  
Another material : Epoxy

Size (mm)	Type	Per pkg.	Part No.
24 x 50	HCS, Wood	1	B-64842

## Bow Shape plunge cut saw blade 32q

TMA051



Feature : Suitable for Precisely plunge cut  
Another material : None

Size (mm)	Type	Per pkg.	Part No.
32 x 50	HCS, Wood	1	B-64858

# Multi-Tool

## Bow Shape plunge cut saw blade 65

TMA052



Feature : Suitable for Precisely plunge cut  
Another material : Epoxy

Size (mm)	Type	Per pkg.	Part No.
65 x 40	HCS, Wood	1	B-64864

## Bow Shape plunge cut saw blade 32

TMA053



Feature : Suitable for Precisely plunge cut  
Another material : Epoxy, Fiberglass

Diameter (mm)	Type	Per pkg.	Part No.
32 x 50	BiM, Wood	1	B-64870

## Bow Shape plunge cut saw blade 32

TMA054



Feature : Suitable for Precisely plunge cut  
Another material : None

Diameter (mm)	Type	Per pkg.	Part No.
32 x 50	HCS, Wood	1	B-64886

## Bow Shape plunge cut saw blade 65

TMA055



Feature : Suitable for Precisely plunge cut  
Another material : Epoxy, Fiberglass

Diameter (mm)	Type	Per pkg.	Part No.
65 x 40	BiM, Wood	1	B-64892

## Bow Shape plunge cut saw blade 65

TMA056



Feature : Suitable for Precisely plunge cut  
Another material : None

Diameter (mm)	Type	Per pkg.	Part No.
65 x 40	HCS, Wood	1	B-64901

## Especially suitable for Metal



## Plunge cut saw blade 32

TMA059



Feature : Suitable for Flush cutting in nails or copper pipe  
Another material : Wooden material, Plasterboard, Epoxy, Fiberglass

Diameter (mm)	Type	Per pkg.	Part No.
32 x 50	BiM, Metal	1	B-64939

## TC Bar plunge cut saw blade 20

TMA060



Feature : Suitable for Flush cutting in hardened screws and nails  
Another material : Wooden material, Plasterboard, Epoxy, Fiberglass

Diameter (mm)	Type	Per pkg.	Part No.
20 x 40	TC/HM, Metal	1	B-64945

## TC Bar plunge cut saw blade 32

TMA061



Feature : Suitable for Flush cutting in hardened screws and nails  
Another material : Wooden material, Plasterboard, Epoxy, Fiberglass

Diameter (mm)	Type	Per pkg.	Part No.
32 x 40	TC/HM, Metal	1	B-64951

## TC Bar plunge cut saw blade 45

TMA079



Feature : Suitable for Flush cutting in hardened screws and nails  
Another material : Wooden material, Plasterboard, Epoxy, Fiberglass

Diameter (mm)	Type	Per pkg.	Part No.
45 x 40	TC/HM, Metal	1	B-69755

# Multi-Tool

## Especially suitable for Multi material



### Serrated Seg Blade 100

TMA063



Feature : Suitable for Insulation material  
Another material : None

Diameter (mm)	Type	Per pkg.	Part No.
100	BiM, Multi Material	1	B-64967

### Segment saw blade 85

TMA064



Feature: Suitable for Plunge cut in plasterboard  
Another material : Wooden material, Nonferrous metal, Sheet metal, softnails

Diameter (mm)	Type	Per pkg.	Part No.
85	BiM-TIN, Multi Material	1	B-64973

### Scraper 52 Rigid

TMA065



Feature : Suitable for Removing mortar or tile adhesive  
Another material : None

Size(mm)	Type	Per pkg.	Part No.
52 x 26	HCS, Multi Material	1	B-64989

### Scraper 52 Flexible

TMA066



Feature: Suitable for Removing soft carpet adhesive residues or silicone joints  
Another material : None

Size(mm)	Type	Per pkg.	Part No.
52 x 40	HCS, Multi Material	1	B-64995

### General Joint Cutter

TMA067



Feature : Suitable for Soft joint material cut  
Another material : None

Size(mm)	Type	Per pkg.	Part No.
28 x 40	HCS, Multi Material	1	B-65006

## Universal purpose knife

TMA068

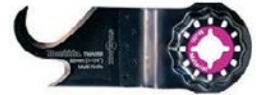

Application/ Recommended Use  
Cutting insulation materials  
Cutting window putty.  
Cutting expansion joints

Size(mm)	Type	Per pkg.	Part No.
11 x 24	HCS	1	B-65012

## TC Bar Bow Shape plunge cut saw blade 32

TMA080



Application/ Recommended Use  
Multi material/ Suitable for precisely plunge cut  
Plunge cut plasterboard, fiberglass, epoxy, aluminum, stainless

Size(mm)	Type	Per pkg.	Part No.
32 x 40	TC/HM, Multi Material	1	B-69761

## Bow Shape plunge cut saw blade 53

TMA081



Feature : Suitable for Precisely and fast plunge cut in plasterboard  
Another material : Wood, Chipboard  
1 Blade does the job of 2 ( plunge & cut on )

Size(mm)	Type	Per pkg.	Part No.
53 x 40	BiM, Multi Material	1	B-69777

## Universal purpose knife

TMA082



Feature : Suitable for Cutting in taeksealant, caulking material  
Another material : None

Size(mm)	Type	Per pkg.	Part No.
12 x 29	Stainless, Multi Material	1	B-69783



# Multi-Tool

## Especially suitable for Grout Abrasive



### TC Seg Saw Blade 85

TMA069



Feature : Suitable for Routing joints on wall and floor tiles  
Another material : Epoxy, Fiberglass, Plasterboard

Diameter (mm)	Type	Per pkg.	Part No.
85	TC/HM grit #30	1	B-65028

### Diamond Seg Saw blade 85

TMA070



Feature : Suitable for Cut out of wall tiles  
Another material : Plasterboard, Epoxy, Fiberglass

Diameter (mm)	Type	Per pkg.	Part No.
85	Diamond grit #40	1	B-65034

### TC Seg Saw Blade 70

TMA071



Feature: Suitable for Routing thin joints on wall tiles  
Another material : Plasterboard, Epoxy, Fiberglass

Diameter (mm)	Type	Per pkg.	Part No.
70	TC/HM grit #50	1	B-65040

### TC Seg Saw Blade 85

TMA072



Feature : Suitable for Routing joints on wall tiles  
Another material : Plasterboard, Epoxy, Fiberglass

Diameter (mm)	Type	Per pkg.	Part No.
85	TC/HM grit #40	1	B-65056

### TC Sanding Plate 78

TMA073



Feature : Suitable for Routing mortar or tile adhesive  
Another material : Wood, Epoxy

Size(mm)	Type	Per pkg.	Part No.
78	TC/HM grit #20	1	B-65062

### TC Remover

TMA074



Feature : Suitable for Routing joints on wall and floor tiles  
Another material : Plasterboard, Epoxy, Fiberglass

Size(mm)	Type	Per pkg.	Part No.
70	TC/HM grit #40	1	B-65078

### TC Plunge Blade 32

TMA075



Feature : Suitable for Removing grouts in narrow corner or tide spaces  
Another material : Wood, Plasterboard, Epoxy, Fiberglass

Size(mm)	Type	Per pkg.	Part No.
32 x 30	TC/HM grit #50	1	B-65084

### TC Sanding Pointer 32

TMA076



Feature : Suitable for Sanding paint in tight gap  
Another material : Wood

Diameter (mm)	Type	Per pkg.	Part No.
32 x 50	TC/HM grit #40	1	B-65090

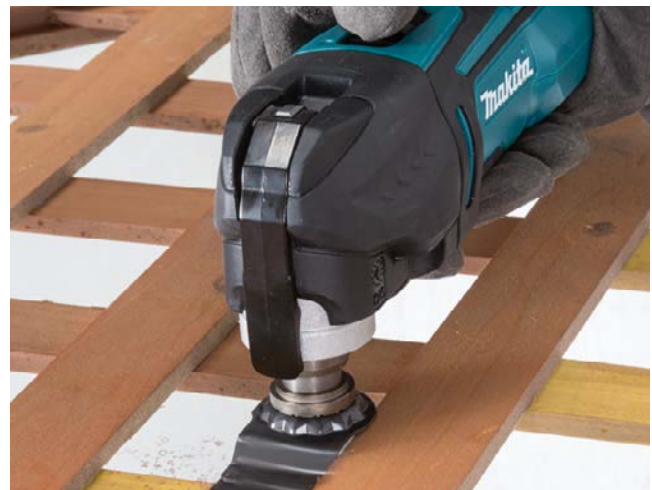

### TC Sanding Pointer 32

TMA077



Feature : Suitable for Sanding paint in tight gap  
Another material : Wood

Diameter (mm)	Type	Per pkg.	Part No.
32 x 50	TC/HM grit #100	1	B-65109



# Multi-Tool

## Sanding pad

TMA078



Size(mm)	Type	Per pkg.	Part No.
93	hook & loop	1	B-65115

## TC Sanding Plate 90

TMA083



Feature : Suitable for Routing mortar, tile adhesive, paint on fiberglass  
Another material : Wooden material, Fiberglass

Size(mm)	Type	Per pkg.	Part No.
90	TC/HM grit #20	1	B-69799

## TC Sanding Plate 90

TMA084



Feature : Suitable for Sanding in wood with paint, paint of fiberglass  
Another material : Wooden material, Fiberglass

Size(mm)	Type	Per pkg.	Part No.
90	TC/HM grit #40	1	B-69808

## TC Sanding Plate 90

TMA085



Feature : Suitable for Sanding Wood  
Another material : Wood

Size(mm)	Type	Per pkg.	Part No.
90	TC/HM grit #60	1	B-69814

## TC Sanding Plate 90

TMA086



Feature : Suitable for Sanding Wood  
Another material : Wood

Size(mm)	Type	Per pkg.	Part No.
90	TC/HM grit #100	1	B-69820

## Multi tool Starlock blade sets

### Tile Set

TMA058 Plunge cut saw blade 20  
TMA065 Scraper 52 rigid  
TMA069 HM Seg saw blade 85  
TMA073 HM Sanding plate 78



Part No.

B-67496

### Floor Set

TMA045 Segment saw blade 85  
TMA048 Plunge cut saw blade 65  
TMA051 Plunge cut saw blade 62  
TMA066 Scraper 52 Flexible



Part No.

B-67505

### Plunge Cut Set

TMA045 Segment saw blade 85  
TMA047 Plunge cut saw blade 32  
TMA053 Bow plunge cut saw blade 32  
TMA058 Plunge cut saw blade 20



Part No.

B-67480

### Carpentry Set

TMA045 Segment saw blade 85  
TMA047 Plunge cut saw blade 32  
TMA053 Bow plunge cut saw blade 32  
Sanding Pad x 2pcs



Part No.

B-67511



# Multi-Tool

## Abrasive delta paper/ Stone



Paper Size(mm)	Grit	Per pkg.	Part No.
94	120	10	B-21749
94	240	10	B-21755
94	400	10	B-21761
94	600	10	B-21777
94	1200	10	B-21783
94	120,240, 400, 600,1200	10 (2pcs/each)	B-21733

## Abrasive delta paper/ Polishing fleece

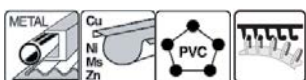

Paper Size(mm)	Grit	Per pkg.	Part No.
94	Coarse / 100	1	B-21808
94	Medium / 280	1	B-21799
94	without grit	1	B-21814

## Abrasive delta paper/ Polishing felt



Paper Size(mm)	Grit	Per pkg.	Part No.
94	Hard	1	B-21820



## Abrasive delta paper/ Wood/ long-life



Paper Size(mm)	Grit	Per pkg.	Part No.
94	60	10	B-21565
94	80	10	B-21571
94	100	10	B-21587
94	120	10	B-21593
94	180	10	B-21602
94	240	10	B-22931

## Abrasive delta paper/ Wood



Paper Size(mm)	Grit	Per pkg.	Part No.
94	60	10	B-21624
94	80	10	B-21630
94	100	10	B-22947
94	120	10	B-21646
94	150	10	B-22953
94	180	10	B-21652
94	240	10	B-21668
94	60,80,120,180,240	10 (2pcs/each)	B-21618

## Abrasive delta paper/ Wood/ economy type



Paper Size(mm)	Grit	Per pkg.	Part No.
94	40	10	D-58578
94	60	10	D-58584
94	80	10	D-58590
94	100	10	D-58609
94	120	10	D-58615
94	150	10	D-58621
94	180	10	D-58637
94	240	10	D-58643
94	320	10	D-58659

## Abrasive delta paper/ Paint



Paper Size(mm)	Grit	Per pkg.	Part No.
94	60	10	B-21680
94	100	10	B-21705
94	120	10	B-22969
94	240	10	B-21711
94	320	10	B-21727
94	60,80,100,240,320	10 (2pcs/each)	B-21674

## Abrasive delta paper (Page 123) applications



Rating Suitability for application

AA: Recommended  
 A: Acceptable  
 n.r.: No Rating

Product Application and Rating On Each Material		Grit	Paint	Varnish	Filler	Roughcast	Wood / Wooden materials	soft wood	hard wood	Plywood	Chipboard/MDF	Metal	Steel (mild steel / carbon steel)	Stone	Marble	Granite	Glass	Perspex	Corian®	Glass fiber reinforced	
Wood / long-life	Coarse	60	n.r.	n.r.	n.r.	n.r.	AA	AA	AA	AA	AA	AA	A	n.r.	n.r.	n.r.	n.r.	n.r.	n.r.	n.r.	n.r.
		80																			
		100																			
	Medium	120																			
		180																			
		240																			
Wood (★★★)	Coarse	60	n.r.	n.r.	n.r.	n.r.	AA	A	AA	AA	AA	n.r.	n.r.	n.r.	n.r.	n.r.	n.r.	n.r.	n.r.	n.r.	n.r.
		80																			
		100																			
	Medium	120																			
		150																			
		180																			
Wood (★★)	Coarse	40	A	A	n.r.	n.r.	AA	AA	AA	AA	A	A	A	n.r.	n.r.	n.r.	n.r.	n.r.	n.r.	n.r.	n.r.
		60																			
		80																			
	Medium	100																			
		120																			
		150																			
Fine	180																				
	240																				
	320																				
Paint	Coarse	60	AA	AA	AA	AA	n.r.	n.r.	A	n.r.	n.r.	A	A	n.r.	n.r.	n.r.	n.r.	n.r.	n.r.	n.r.	n.r.
		80																			
		100																			
	Medium	120																			
		240																			
		320																			
Stone	Medium	120	A	AA	n.r.	n.r.	n.r.	n.r.	n.r.	n.r.	n.r.	n.r.	A	A	A	A	A	A	A	A	
		240																			
		400																			
	Fine	600																			
		Very fine																			1200



# ACCESSORIES

## □ Diamond



Wet



Hook and loop type



Do not drill with impact

# Diamond

## Diamond Wheels



### Segmented Type:

Most commonly used. Blade has slits and layers of diamond are sintered on edges. Cut faster than continuous rim type and attain average cutting surface.

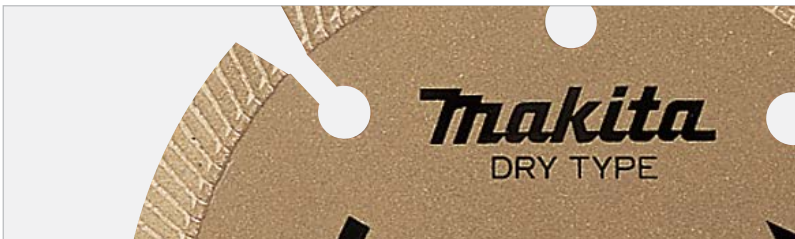

### Segmented Wave Type:

This wheel has slits like segmented wheel. Each segment has many notches (Wave). These notches assure;

- Fast cutting with less resistance.
- Smooth debris removal.
- Less loading on wheel.



### Corrugated Type:

This wheel has notches around the Rim. Has a characteristic between Continuous Rim and Segmented Type. Has faster cutting like Segmented Type. At the same time, can attain cleaner surface like continuous rim without broken edges.



### Continuous Rim Type:

Has layer of diamond with uniform thickness around the entire rim. Can attain clean surface even on crusty, brittle materials. Cut with accuracy but not as fast as segmented type wheel.

## SPECIALIZED



### Electrodeposited Type:

Diamonds are electrodeposited and has more exposure than bonded type. Cuts faster and more efficient.



### Vacuum brazed Type:

Diamonds are vacuum brazed and has more exposure than bonded type. Able to cut harder material. It is longer life than electrodeposited type because diamonds are held tightly.



### Crack Chaser:

Blade is thicker than regular blades. Designed for repair the wall easily.

# Diamond

## Diamond Wheel

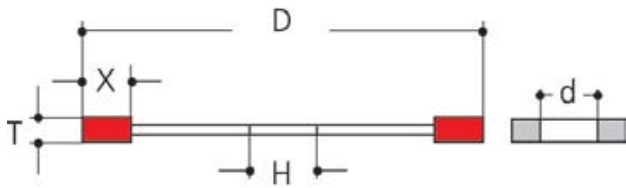

(EN) : EN13236

AA: Specially suitable, A: Suitable

## Ring

(10 pcs. /set)  
(mm)

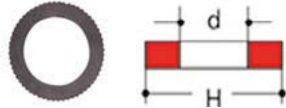

Description	(H) Outer Dia	(D) Hole Dia	Part No.
Ring 20	22.23	20	A-85248
Ring 16	20	16	A-86860



## Material

Material No.1						
Hard concrete	Granite	Gneiss	Smoothable Engineering	Carbonaceous Shale	Sidewalk Slate	Engineering Block/ Engineering Block Class 2

Material No.2					Material No.3	
Concrete	Block	U-shaped Groove	Sidewalk Block	Cemented Tile	Marble	Unglazed Tile

Material No.4			Material No.5	Material No.6	Material No.7
Brick	Aggregate Block	French Tile	Asphalt	Tile	Glass

# Diamond

## Diamond Wheel for Concrete



### X-LOCK

Four-star range

★★★★

<Ideal for Concrete / Dry>



# XLOCK

Shape	D	T	X	H	d	Color	For Material							Model No.	Part No.
							1	2	3	4	5	6	7		
	100	1.6	7	X-LOCK	-	Blue	AA	AA	AA	A	-	-	-	X-LOCK 100mm Grinder	E-02054(EN)
	125	1.6	7	X-LOCK	-	Blue	AA	AA	AA	A	-	-	-	X-LOCK 125mm Grinder	E-02076(EN)

### Segmented

Four-star range

★★★★

<Ideal for Concrete / Dry>



Shape	D	T	X	H	d	Color	For Material							Model No.	Part No.
							1	2	3	4	5	6	7		
	230	2.4	15	22.23	-	Blue	AA	AA	AA	A	-	-	-	230mm DC Power cutter	E-02967(EN)
	355	2.8	10	25.4	-	Blue	AA	AA	AA	A	-	-	-	355mm DC Power cutter, 355mm Engine power cutter	E-12996(EN)

#### 1. Ideal for cordless tools

##### The distance of cutting for 1 Battery charge

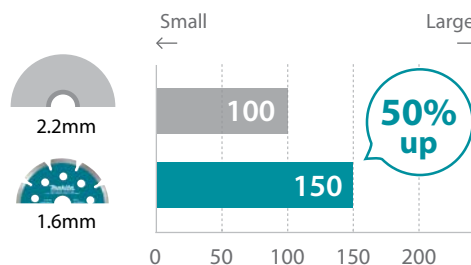

Note:

The test results depend to a great extent on the hardness of materials, etc.  
The numbers in the bar graphs are relative values when the capacity of Makita Diamond Wheel (Thickness:2.2mm) is indexed at 100.

#### 2. Thin blade & Light weight



This blade is designed as 1.6mm (the basis is 1.1mm). So smooth and light cutting is available.

It was lightened by punching the body. (eg:ø125mm blade is 95g [current blade : 125g]) It is also reduced the load on the battery and increased the cutting distance per 1 battery charge.

# Diamond

Two-star range



<Ideal for Concrete / Dry>

Shape	D	T	X	H	d	Color	For Material							Model No.	Part No.
							1	2	3	4	5	6	7		
	180	2.3	7	25.4	22.23	Gold	-	AA	AA	A	A	-	-	180mm Grinder, 180mm Cutter	A-84121(EN)

Long Life

<Ideal for Concrete / Dry>

	105	2	7	20	16	Gold	-	AA	AA	A	A	-	-	100mm Grinder, 110mm Cutter	D-05197
	125	2.2	7	20	-	Gold	-	AA	AA	A	-	-	-	125mm Cutter	D-37568

One-star range



<Ideal for Concrete / Dry>

	105	1.8	7	20	-	Gold	-	AA	-	-	-	-	-	100mm Grinder, 110mm Cutter	D-79566
	105	2	7	20	16	Gold	A	AA	A	A	-	-	-	100mm Grinder, 110mm Cutter	D-42531
	180	2.4	7	22.23	-	Gold	A	AA	A	A	-	-	-	180mm Grinder	D-44286
	230	2.6	7	22.23	-	Gold	A	AA	A	A	-	-	-	230mm Grinder	D-44292

<Ideal for Concrete / Dry>

	105	2.2	9	20	16	Gold	-	AA	-	-	-	-	-	100mm Grinder, 110mm Cutter	D-71009
	125	2.2	9	22.23	20	Gold	-	AA	-	-	-	-	-	125mm Grinder, 125mm Cutter	D-71021

## Corrugated

Three-star range



<Ideal for Concrete / Dry>

Shape	D	T	X	H	d	Color	For Material							Model No.	Part No.
							1	2	3	4	5	6	7		
	125	2.1	7	22.23	20	Gold	-	AA	AA	A	A	-	-	125mm Grinder, 125mm Cutter	A-84159(EN)
	180	2	7	22.23	-	Blue	AA	AA	AA	A	A	-	-	180mm Grinder	A-80709(EN)
	230	2.6	7	22.23	-	Gold	-	AA	AA	A	A	-	-	230mm Grinder	A-84171(EN)

Long Life

<Ideal for Concrete / Dry>

	105	2	7	20	16	Gold	-	AA	AA	A	-	-	-	100mm Grinder, 110mm Cutter	D-05206
	110	2.2	7	20	16	Gold	-	AA	AA	A	-	-	-	100mm Grinder, 110mm Cutter	D-42640



# Diamond

## Segmented wave

Three-star range



<Ideal for Concrete / Dry>

Shape	D	T	X	H	d	Color	For Material							Model No.	Part No.
							1	2	3	4	5	6	7		
	125	2	7.5	22.23	-	Blue	-	AA	AA	A	A	-	-	125mm Grinder	A-80438(EN)

<Concrete & Granite / Dry>

	180	2.2	8	22.23	-	Gold	AA	AA	AA	A	A	-	-	180mm Grinder	B-02060
	230	2.5	7.5	22.23	-	Gold	AA	AA	AA	A	A	-	-	230mm Cutter	B-02004

One-star range



<Ideal for Concrete, Granite/ Dry>

	115	2	7	22.23	-	Blue	AA	AA	A	A	-	-	-	115mm Grinder	D-41420
	230	2.8	7	22.23	-	Blue	AA	AA	A	A	-	-	-	230mm Grinder	D-44345

## Continuous rim

Three-star range



<Ideal for Tile, Concrete & Brick / Wet>



Shape	D	T	X	H	d	Color	For Material							Model No.	Part No.
							1	2	3	4	5	6	7		
	76	1.6	5	20	-	Violet	-	-	-	-	-	AA	-	76mm Cutter	D-77263
	110	1.6	5	20	-	Gold	-	AA	AA	A	-	A	-	110mm Cutter	D-05212
	110	1.5	4	20	-	Gold	A	AA	AA	A	A	AA	-	110mm Cutter	A-07185



# Diamond

## Diamond Wheel for Stone



## Segmented wave

Three-star range



<Ideal for Granite / Dry>

Shape	D	T	X	H	d	Color	For Material							Model No.	Part No.
							1	2	3	4	5	6	7		
	125	2	7.5	20	-	Gold	AA	AA	AA	AA	A	-	-	4105KB	792282-5

Two-star range



<Ideal for Granite / Dry>

	105	1.7	7	20	16	Silver	AA	AA	AA	A	A	-	-	100mm Grinder, 110mm Cutter	A-84090
	125	2	7	22.23	20	Silver	AA	AA	AA	A	A	-	-	125mm Grinder, 125mm Cutter	A-84012
	180	2	6	25.4	22.23	Silver	AA	AA	AA	A	A	-	-	180mm Grinder, 180mm Cutter	A-84028

One-star range



<Ideal for Granite, Marble / Dry>



	105	2.2	7	20/16	16	Silver	AA	-	-	-	-	-	-	100mm Grinder, 110mm Cutter	D-41399
	105	2.2	7	20/16	16	Green	-	-	AA	-	-	-	-	100mm Grinder, 110mm Cutter	D-41408

## Corrugated

Two-star range



<Ideal for Granite / Dry>

	105	2	7	20	16	Silver	AA	AA	AA	A	A	-	-	100mm Grinder, 110mm Cutter	A-84040(EN)
--	-----	---	---	----	----	--------	----	----	----	---	---	---	---	-----------------------------	-------------

Two-star range



<Ideal for Ceramic and porcelain/ Wet&Dry>

	105	1.2	7	20	16	Violet	-	-	-	-	-	AA	-	100mm Grinder, 110mm Cutter	D-77198
--	-----	-----	---	----	----	--------	---	---	---	---	---	----	---	-----------------------------	---------

One-star range



<Ideal for Granite, Marble / Dry>

	105	2.2	7	20	16	Silver	AA	A	AA	A	-	-	-	100mm Grinder, 110mm Cutter	D-42553
--	-----	-----	---	----	----	--------	----	---	----	---	---	---	---	-----------------------------	---------

# Diamond

## Diamond Wheel for Tile



## Corrugated

Four-star range  
★★★★



1. Ideal for cordless tools

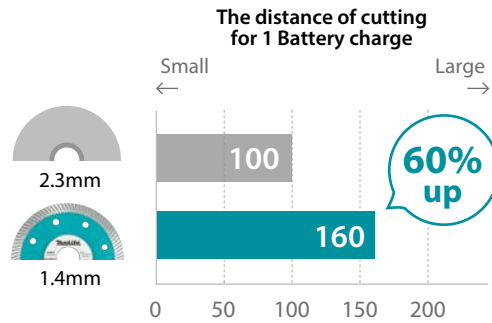

2. Thinner blade

With the bare necessities of thickness which able to have enough strength, able to get smooth and light cutting.

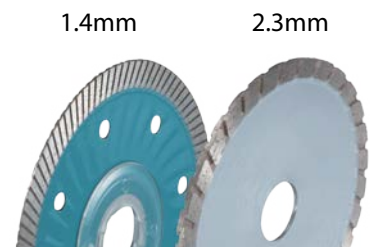

Note:

The test results depend to a great extent on the hardness of materials, etc. The numbers in the bar graphs are relative values when the capacity of Makita Diamond Wheel (Thickness:2.3mm) is indexed at 100.

<Ideal for Porcelain Tile / Dry>  
Thin type

Shape	D	T	X	H	d	Color	For Material							Model No.	Part No.
							1	2	3	4	5	6	7		
	105	1.4	10	22.23	16	Blue	-	A	A	AA	-	AA	-	100mm Grinder	B-49030(EN)

## Continuous rim

Three-star range  
★★★

<Wet>



	110	1.5	4	20	-	Gold	A	AA	AA	A	A	AA	-	110mm Cutter	A-81131
--	-----	-----	---	----	---	------	---	----	----	---	---	----	---	--------------	---------

## Diamond Wheel for Glass



## Corrugated

Three-star range  
★★★

<Ideal for Bulletproof Glass / Wet>

	110	1.2	6	20	-	Blue	-	-	AA	A	A	AA	AA	110mm Cutter	B-00795
--	-----	-----	---	----	---	------	---	---	----	---	---	----	----	--------------	---------

# Diamond

## Specialized / Vacuum brazed Diamond Wheel

### 1. Cut various material

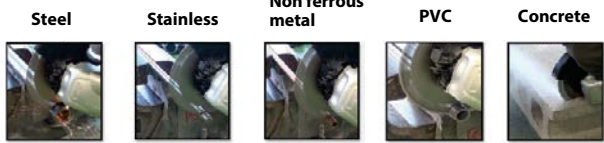

The diamond abrasive grain are adhered on wheel surface directly which is different from the regular wheel containing diamond abrasive grain buried on layers .

### 2. Less spark

Diamond wheel



Abrasive Cut off wheel



The major general contractor dislike sparks at the work site, so you can recommend this blade to these work site.



Multi cut  
(Dry)

Shape	D	T	X	H	d	Color	For Material							Model No.	Part No.
							1	2	3	4	5	6	7		
	110	2	5.0	20	16	Violet	A	A	A	A	-	-	-	100mm Grinder, 110mm Cutter	D-44426
	125	2.8	4.0	22.23	-	Red	A	A	A	A	A	A	A	125mm Grinder	B-55310(EN)
	230	3.1	4.0	22.23	-	Red	A	A	A	A	A	A	A	230mm Grinder	B-55326(EN)
	300	3.4	4.0	25.4	20	Red	A	A	A	A	A	A	A	305mm Power Cutter	B-55332(EN)
	355	2.8	4.0	25.4	20	Red	A	A	A	A	A	A	A	350mm Power Cutter	B-55348(EN)

For Metal

	100	1.3	1.5	16	-	Violet	-	-	-	-	-	-	-	100mm Grinder	B-53671(EN)
	125	1.3	1.5	22.23	-	Violet	-	-	-	-	-	-	-	125mm Grinder	B-53693(EN)
	180	1.3	1.5	22.23	-	Violet	-	-	-	-	-	-	-	180mm Grinder	B-53702(EN)

## Specialized / Tungsten Carbide Grit Blade



Shape	D	T	X	H	d	Color	For Material							Model No.	Part No.
							1	2	3	4	5	6	7		
PVC / Plaster board / Epoxy	76	-	-	10	-	Blue	-	-	-	-	-	-	-	DMC300	D-74837

# Diamond

## Specialized / Cordless Cutter



Shape	D	T	X	H	d	Color	For Material							Model No.	Part No.
							1	2	3	4	5	6	7		
High Grade / Continuous rim / Wet	80	0.8	4.0	15	-	Silver	-	-	-	-	-	AA	AA	4190DW, 4191DW	792296-4
Standard / Glass & Tile / Wet	85	0.9	4.0	15	-	Silver	-	-	-	-	AA	AA	CC330D	B-21082	
Standard / Electrodeposited / Glass & Porcelain / Wet	85	0.8	2.2	15	-	Silver	-	-	AA	-	-	AA	AA	CC300D, 4190DW, 4191DW	A-07179

## Specialized / Engine Power Cutter Tools

Laser Welded



Shape	D	T	X	H	d	Color	For Material							Model No.	Part No.
							1	2	3	4	5	6	7		
Standard / Segmented / Concrete, Brick	300	2.8	7.5	25.4	20	Gold	A	AA	A	AA	-	-	-	305mm Power Cutter	D-56982(EN)
Standard / Segmented / General	350	3.2	5	25.4	20	Silver	A	AA	AA	AA	-	-	-	355mm Power Cutter	A-87317
Standard / Segmented / Concrete, Brick	350	2.8	7.5	25.4	20	Gold	A	AA	A	AA	-	-	-	355mm Power Cutter	D-56998(EN)
Standard / Segmented / Concrete, Brick	400	3	7.5	25.4	20	Gold	A	AA	A	AA	-	-	-	405mm Power Cutter	D-57009(EN)

## Specialized / 305mm Cutter, Engine Power Cutter Tools



Shape	D	T	X	H	d	Color	For Material							Model No.	Part No.
							1	2	3	4	5	6	7		
Standard / Segmented / Asphalt / Dry	305	3	7.5	30	20,	Silver	-	-	-	-	A	-	-	305mm Cutter, Power Cutter	A-02484
Standard / Segmented / Concrete & Asphalt / Dry	305	3	7.5	30	22.23, 25.4	Blue	-	AA	AA	AA	A	-	-	305mm Cutter, Power Cutter	A-02490

## Specialized / 355mm Portable Cut-off Tools



Shape	D	T	X	H	d	Color	For Material							Model No.	Part No.
							1	2	3	4	5	6	7		
Vacuum brazed / Metal	355	3.3	4	25.4	-	Violet	-	-	-	-	-	-	-	355mm Portable Cut-off	D-41414



## Specialized / Wall Chaser Tools





Shape	D	T	X	H	d	Color	For Material							Model No.	Part No.
							1	2	3	4	5	6	7		
Segmented / Dry	125	2	7.5	22.23	-	Blue	-	AA	AA	A	A	-	-	SG1251	A-80438(EN)
Segmented / Dry	155	2	7	22.23	-	Blue	-	AA	AA	A	A	-	-	SG150	A-83836

# Diamond

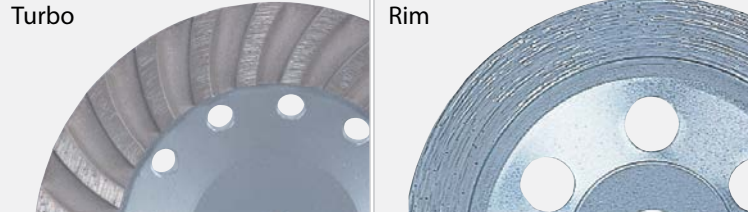

## Offset Diamond Wheels

<p>Single</p> 	<p><b>Rough work</b> This wheel grind more efficiency. Faster than the wheel for standard work.</p>
<p>Double      Segmented      Fan</p> 	<p><b>Standard work</b> This wheel has a characteristic between Rough work offset diamond wheels and Fine work offset diamond wheels.</p>
<p>Turbo      Rim</p> 	<p><b>Fine work</b> This wheel is suitable for cleanup and finish work and chamfering works.</p>

### SPECIALIZED

<p>PCD</p> 	<p><b>Removal of paint</b> This wheel is suitable for removal of polyurethane, adhesive, paint, epoxy and acrylic coating. PCD is an abbreviations of "Polycrystalline Diamond". It is a kind of an artificial diamond and superior in hardness and durability.</p>
<p>Vacuum brazed</p> 	<p><b>For hard materials</b> This wheel is suitable for hard materials. Diamonds are held tightly.</p>

### Low Vibration Offset Diamond Wheel

	<p><b>Low Vibration</b> The vibration is not conducted to the worker's hand and able to ease the load a lot!!</p> <p><b>Less Tapping</b> Clinging to the material and able to cut smoothly, faster and more efficient.</p> <p><b>Low Vibration Type</b></p> <p>Normal  →  Low Vibration Type</p>
---	--

# Diamond

## Offset diamond wheel

AA: Specially suitable, A: Suitable  
(EN) : EN13236



**Rough Work**  
Single type

Three-star range

★★★

D	T	X	H	d	For Material					Model No.	Part No.
					1	2	3	4	5		
105	8	4.0	22.23	-	A	AA	A	A	A	115mm Grinder	B-14629

One-star range

★

100	0.8	2.2	16	-	A	AA	A	A	A	100mm Grinder	D-62284
-----	-----	-----	----	---	---	----	---	---	---	---------------	---------

**Standard work**

Double type  
• Stable work



Three-star range

★★★

D	T	X	H	d	For Material					Model No.	Part No.
					1	2	3	4	5		
125	8	5	22.23	-	AA	AA	AA	A	A	PC5010C 125mm Grinder	B-12295(EN)

Two-star range

★★

125	7	5	22.23	-	A	AA	A	A	A	PC5010C	D-41458(EN)
-----	---	---	-------	---	---	----	---	---	---	---------	-------------

Segmented type

• More clean surface finish



Three-star range

★★★

D	T	X	H	d	For Material					Model No.	Part No.
					1	2	3	4	5		
100	8	5	22.23	16	AA	AA	AA	A	A	115mm Grinder	A-87105

**Fine work**

Turbo type  
• Good dust removal, and high efficiency  
• Stable work and easy to grind the corners



Three-star range

★★★

D	T	X	H	d	For Material					Model No.	Part No.
					1	2	3	4	5		
105	10	5	22.23	-	A	AA	A	A	A	115mm Grinder	B-44993

Rim type

- More clean surface finish
- Stable work and easy to grind the corners



Three-star range

★★★

D	T	X	H	d	For Material					Model No.	Part No.
					1	2	3	4	5		
125	13.5	4	22.23	-	AA	AA	AA	A	A	PC5010C 125mm Grinder	B-12289(EN)

One-star range

★

125	13	5	22.23	-	AA	AA	AA	A	A	PC5010C 180mm Grinder	D-41464(EN)
-----	----	---	-------	---	----	----	----	---	---	-----------------------	-------------

## Specialized/ PCD Offset Diamond Wheel

This Offset Diamond Wheel can be used for removing of polyurethane, adhesive, paint, epoxy and acrylic coatings.

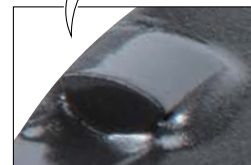

< Difference with the normal offset diamond >



It just scratched the surface and couldn't remove the paint film.

Specialized

D	T	X	H	d	For Material					Model No.	Part No.
					1	2	3	4	5		
125	-	-	22.23	-	-	-	-	-	-	PC5010C 125mm Grinder	B-53160
180	-	-	22.23	-	-	-	-	-	-	PC5010C 180mm Grinder	B-53176

# Diamond

## SDS-Plus Diamond core bit (Dry type)

When drilling with diamond core bit, always use "rotation only".  
SDS-Plus adapter (with center bit) A-87563



For Model:  
SDS-PLUS hammers  
Spindle thread M18



Capacity (Diameter x Depth)	Part No.
38 x 175mm	A-87535
54 x 175mm	A-87541

## Vacuum brazed diamond pin drill



For: 13mm Driver Drill  
Material : Granite/Marble/Porcelain Tile

Size	Spindle thread	Part No.
6mm	6mm x 12.5mm	B-51823
8mm	8mm x 12.5mm	B-51839
10mm	10mm x 12.5mm	B-51845

## Vacuum brazed diamond core bit



Diamond Core Drill Bit for Grinders	
Type	Vacuum brazed
Fix	Special chemical bond
Fixing strength of diamond	High
Cutting material	Marble, Granite, Porcelain Tile
Precision of cutting	Middle

For: 115mm, 125mm, 150mm, 180mm, 230mm Angle Grinder  
Material : Granite/Marble/Porcelain Tile

Size	Spindle thread	Part No.
5 mm	M14 x 2	D-61064
6mm	M14 x 2	D-61070
8mm	M14 x 2	D-61086
10mm	M14 x 2	D-61092
12mm	M14 x 2	D-61101
14mm	M14 x 2	D-44432
16mm	M14 x 2	D-44448
20mm	M14 x 2	D-44454
22mm	M14 x 2	D-44460
25mm	M14 x 2	D-44476
27mm	M14 x 2	D-44482
30mm	M14 x 2	D-44498
32mm	M14 x 2	D-44507
35mm	M14 x 2	D-44513
38mm	M14 x 2	D-44529
40mm	M14 x 2	D-44535

Spindle thread M10  
For: 100mm Angle Grinder

5mm	M10 x 1.5	D-75063
6mm	M10 x 1.5	D-63270
8mm	M10 x 1.5	D-63286
10mm	M10 x 1.5	D-75091
12mm	M10 x 1.5	D-63301
14mm	M10 x 1.5	D-63317
16mm	M10 x 1.5	D-75122
20mm	M10 x 1.5	D-63339
25mm	M10 x 1.5	D-75150
32mm	M10 x 1.5	D-63351
37mm	M10 x 1.5	D-63367
40mm	M10 x 1.5	D-63373
50mm	M10 x 1.5	D-63389



# ACCESSORIES

## ▣ Planing / Routering

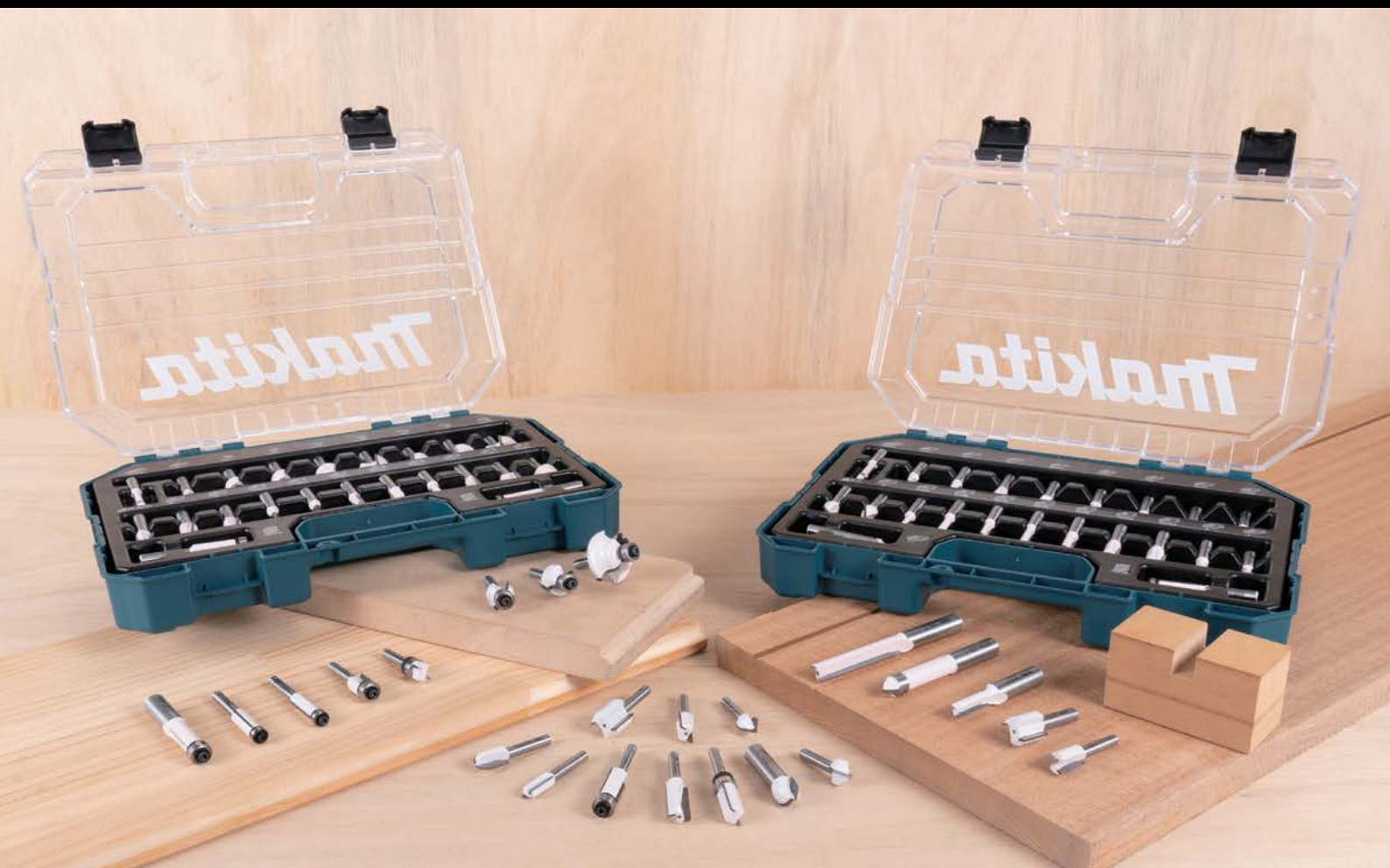

Wood



Aluminum



High speed steel

# Planing / Routering

## Planer blade/ HSS (2 per pkg.)

HSS(High Speed Steel): Fine cutting surface.  
TC(Tungsten Carbide): Higher durability.  
Suitable for hard wood.



For Model	Size (mm)	Material	Part No.
1600	80	HSS	D-65501
1100/N, N1900B, 1902, N1923B/H, KP0810/C, KP0800, DKP180, DKP181	82	HSS	D-16346
	82	HSS	A-07406
	82	TC	793007-0
	82	TC	D-07967
1002BA, 1911B	110	HSS	D-71211
	110	TC	D-08822
	110	TC	793009-6
1804N	136	TC	793012-7
	136	HSS	D-71227
1805N	155	HSS	D-70910
2012NB	306	HSS	199911-5
2040	400	HSS	793019-3

## Mini planer blade

(2 blades per pkg.)  
The blade has edges on both sides for long life.  
HSS(High Speed Steel): Fine cutting surface.  
TC(Tungsten Carbide): Higher durability.



For Model	Size (mm)	Material	Type	Part No.
1100/N, N1900B, 1902, N1923B/H, KP0810/C, KP0800, DKP180, DKP181	82	TC	-	A-82921
2012NB	306	HSS	-	793346-8

## Cutter blade

Carbide-tipped plate joiner blade



For Model:  
3901,PJ7000, DPJ180, DPJ140

Blade Dia. (mm)	Hole Dia. (mm)	Tip Thickness (mm)	Part No.
100	22	4	B-20644

## Drywall guide bit

HSS(High Speed Steel): Fine cutting surface.  
TC(Tungsten Carbide): Higher durability.  
Suitable for hard wood.



For Model:	Size	Type	Per Pkg.	Part No.
3706, DCO181	3.00mm	-	1	193450-7
	1/8"	-	1	191G69-8

## Cutter blade

Dia. 120mm  
For Model:  
3501N



Width (mm)	Region A Part No.	Width (mm)	Part No.
2.4	793021-6	12	793031-3
5.5	793026-6	18	793041-0
-	-	21	793042-8
7.5	793028-2	30	793043-6
-	-	33	793044-4
10.5	793030-5	36	793045-2

# Planing / Routering

## Router bit set

(12 pc/ set)

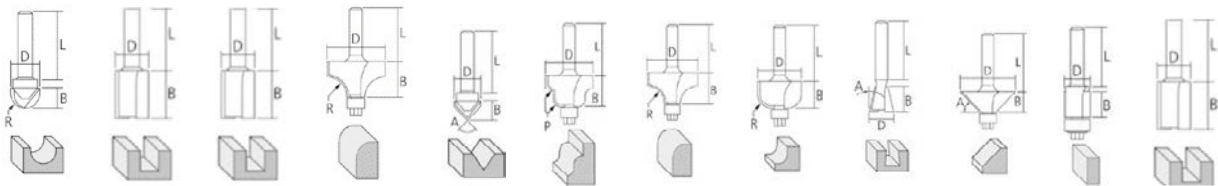

(mm)

Size	#1	#2	#3	#4	#5	#6	#7	#8	#9	#10	#11	#12	Part No.
8													A-88054
6	D:12.7 R:6.35 B:8.8 L:29.0	D:16.0 B:20.0 L:28.0	D:6.0 B:20.0 L:25.0	D:28.6 R:9.5 B:17.0 L:25.5	D:12.7 B:9.1 A:90° L:29.0	D:25.0 R:4.0 B:16.0 L:26.5	D:22.2 R:6.3 B:13.5 L:25.0	D:22.0 R:6.3 B:12.7 L:26.5	D:12.7 B:12.7 A:14° L:29.0	D:32.0 B:12.2 A:45° L:30.0	D:12.7 B:13.0 L:29.0	D:12.0 B:20.0 L:28.0	A-87921
1/4"													A-91051

## Router bit set

(3 pc/ set)

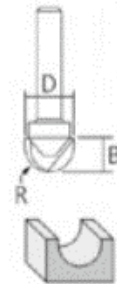
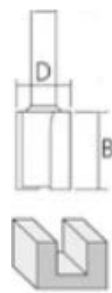

Size	#1	#2	#3	Part No.
1/4"	D:1/4" B:3/4"	D:1/2" B:1/2"	D:1/2" B:3/8" R:1/4"	D-70465

# Planing / Routering

## Straight bit 1flute



Range	Shank dia. mm(inch)	Overall dia. mm(inch)	Length mm(inch)	Carbide height mm(inch)	Sales pkg q'ty	Part No.
★★★★☆	6	6	50	18	1	D-09167
	(1/4)	(15/64)	(2-1/32)	(23/32)	1	D-09173
★★★★☆	8	4	51	13	1	D-47385
	8	6	51	19	1	D-47400
★★★☆☆	(1/4)	(1/4)	(2)	(3/4)	1	D-49030
	(1/2)	(1/4)	(2-1/2)	(3/4)	1	D-62739
	(1/2)	(3/8)	(2-1/2)	(1)	1	D-62745

## Straight bit 2flute



Range	Shank dia. mm(inch)	Overall dia. mm(inch)	Length mm(inch)	Carbide height mm(inch)	Sales pkg q'ty	Part No.
★★★★☆	6	8	52	20	1	D-09260
	6	20	52	20	1	D-09313
	12	10	38	30	1	D-10182
	12	12	61	30	1	D-07892
	(1/4)	(5/16)	(2-1/64)	(3/4)	1	D-15388
	(1/2)	(25/64)	(2-47/64)	(1)	1	D-15512
★★★☆☆	(1/2)	(15/32)	(2-13/32)	(1-3/16)	1	D-07901
	8	6	48	16	1	D-47503
	8	6	51	19	1	D-47519
	8	22	57	25.4	1	D-47597
	12	19	73	32	1	D-47662
	12	25	73	32	1	D-47684
	(1/4)	(1/4)	(2-1/4)	(1)	1	D-49052
	(1/2)	(1/4)	(2-1/2)	(3/4)	1	D-62751
	(1/2)	(1/2)	(2-5/8)	(1)	1	D-62767
	(1/2)	(1/2)	(3)	(1-1/2)	1	D-62773
★★★☆☆	(1/2)	(1/2)	(4)	(2)	1	D-62810
	(1/2)	(3/4)	(2-5/8)	(1)	1	D-62789
	(1/2)	(3/4)	(3)	(1-1/2)	1	D-62795
	(1/2)	(7/8)	(2-5/8)	(1)	1	D-62804

## Straight bit 2flute with top bearing

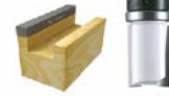

Range	Shank dia. mm(inch)	Overall dia. mm(inch)	Length mm(inch)	Carbide height mm(inch)	Sales pkg q'ty	Part No.
★★★☆☆	(1/2)	(3/4)	(2-13/16)	(1)	1	D-62826

## Flush trim bit 2flute



Range	Shank dia. mm(inch)	Overall dia. mm(inch)	Length mm(inch)	Carbide height mm(inch)	Sales pkg q'ty	Part No.
★★★★☆	6	9.5	58	25.4	1	D-09472
	(1/4)	(3/8)	(2-39/64)	(1)	1	D-04313
★★★★☆	6	9.5	67	26	1	D-47690
	(1/4)	(3/8)	(2-5/8)	(1)	1	D-49264
★★★☆☆	(1/2)	(1/2)	(3-19/32)	(1-1/2)	1	D-62832
	(1/2)	(1/2)	(4-1/64)	(2)	1	D-62848
	(1/2)	(3/4)	(3-5/16)	(1-1/4)	1	D-62860

## Panel pilot bit



Range	Shank dia. mm(inch)	Overall dia. mm(inch)	Length mm(inch)	Carbide height mm(inch)	Sales pkg q'ty	Part No.
★★★★☆	6	6	65	19	1	D-09335

# Planing / Routing

## Sash router bit



Range	Shank dia. mm(inch)	Overall dia. mm(inch)	Length mm(inch)	Carbide height mm(inch)	Sales pkg q'ty	Part No.
★★★★☆	6	6	65	18	1	D-16988
	(1/4)	(15/64)	(2-9/16)	(45/64)	1	D-16972

## Core box bit

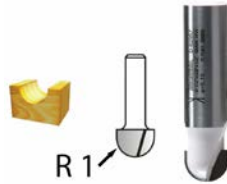

Range	Shank dia. mm(inch)	Overall dia. mm(inch)	Length mm(inch)	Carbide height mm(inch)	R1 mm (inch)	Sales pkg q'ty	Part No.
★★★★☆	8	6.35	38	6.35	3.2	1	D-47977
	8	12.7	41	10	6.35	1	D-48000

## Round nose bit



Range	Shank dia. mm(inch)	Overall dia. mm(inch)	Length mm(inch)	Carbide height mm(inch)	R1 mm (inch)	Sales pkg q'ty	Part No.
★★★★☆	6	6	48	13	3	1	D-09329
★★★★☆	8	6.35	44	12.7	3.2	1	D-47830
	(1/4)	(1/4)	(1-3/4)	(1/2)	(1/8)	1	D-49345
★★★★☆	(1/2)	(3/8)	(2-1/4)	(1/2)	(3/16)	1	D-62876
	(1/2)	(1/2)	(2-3/8)	(3/4)	(1/4)	1	D-62882
	(1/2)	(3/4)	(2-5/8)	(1)	(3/8)	1	D-62898

## V groove bit

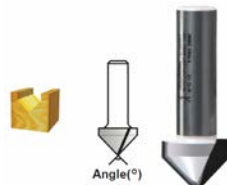

Range	Shank dia. mm(inch)	Overall dia. mm(inch)	Length mm(inch)	Carbide height mm(inch)	(°)	Sales pkg q'ty	Part No.
★★★★☆	6	19	53	20	60	1	D-09391
★★★★☆	8	12.7	45	12.7	90	1	D-47896
	8	12.7	48	16	60	1	D-47961
★★★★☆	8	15.9	44	12.7	90	1	D-47905
	8	19	48	16	90	1	D-47933
	12	12.7	54	12.7	90	1	D-47911

Range	Shank dia. mm(inch)	Overall dia. mm(inch)	Length mm(inch)	Carbide height mm(inch)	(°)	Sales pkg q'ty	Part No.
★★★★☆	(1/4)	(3/4)	(1-7/8)	(5/8)	90	1	D-49373
	(1/2)	(7/8)	(2-1/4)	(5/8)	90	1	D-62907
	(1/2)	(1)	(2-3/8)	(3/4)	90	1	D-62913

## Ovolo bit



Range	Shank dia. mm(inch)	Overall dia. mm(inch)	Length mm(inch)	Carbide height mm(inch)	R1 mm (inch)	Sales pkg q'ty	Part No.
★★★★☆	6	16	41	9	4	1	D-09357
	6	25	45	13	8	1	D-09363

## Roundover bit



Range	Shank dia. mm(inch)	Overall dia. mm(inch)	Length mm(inch)	Carbide height mm(inch)	R1 mm (inch)	Sales pkg q'ty	Part No.
★★★★☆	6	19	42	9.5	3	1	D-09422
	6	25	45	13	6	1	D-09444
		(1/4)	(7/8)	(2-3/16)	(1/2)	(3/16)	1
★★★★☆	8	17.3	51	8	2.3	1	D-48343
	8	20.7	52	10	4	1	D-48365
	8	22.2	55	12.7	4.8	1	D-48371
	8	25.4	56	13.5	6.35	1	D-48387
	8	28.6	57	14.5	7.9	1	D-48393
	(1/2)	(5/8)	(2-5/32)	(15/32)	(1/16)	1	D-63046
	(1/2)	(3/4)	(2-5/16)	(3/8)	(1/8)	1	D-63052
	(1/2)	(1-1/4)	(2-11/16)	(21/32)	(3/8)	1	D-63068
	(1/2)	(1-1/2)	(2-11/16)	(3/4)	(1/2)	1	D-63074

# Planing / Routing

## Beading bit



Range	Shank dia. mm(inch)	Overall dia. mm(inch)	Length mm(inch)	Carbide height mm(inch)	R1 mm (inch)	Sales pkg q'ty	Part No.
★★★★☆	6	21	42	9.5	4	1	D-09525
	6	28	45	13	8	1	D-09547
★★★★☆	8	20.7	51	10	4	1	D-48505

## Roman ogee bit



Range	Shank dia. mm(inch)	Overall dia. mm(inch)	Length mm(inch)	Carbide height mm(inch)	R1 mm (inch)	Sales pkg q'ty	Part No.
★★★★☆	6	24	42	10	2.5	1	D-09575
	6	28	44	12	3	1	D-09581
★★★★☆	6	25.4	52	9.5	3.2	1	D-48804
	8	38.1	60	17.5	6.35	1	D-48767

## Cove bit



Range	Shank dia. mm(inch)	Overall dia. mm(inch)	Length mm(inch)	Carbide height mm(inch)	R1 mm (inch)	Sales pkg q'ty	Part No.
★★★★☆	6	20	40	8	4	1	D-09400
	6	25	45	13	8	1	D-09416

## Classic panel bit



Range	Shank dia. mm(inch)	Overall dia. mm(inch)	Length mm(inch)	Carbide height mm(inch)	R1 mm (inch)	Sales pkg q'ty	Part No.
★★★★☆	8	12.7	42	10	2.4	1	D-48206
	12	25.4	54	16	5.6	1	D-48228

## Cove with fillet bit



Range	Shank dia. mm(inch)	Overall dia. mm(inch)	Length mm(inch)	Carbide height mm(inch)	R1 mm (inch)	Sales pkg q'ty	Part No.
★★★★☆	6	22	42	10	3	1	D-09553

## Dovetail bit

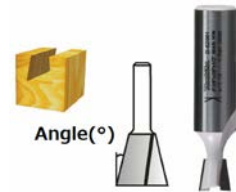

Range	Shank dia. mm(inch)	Overall dia. mm(inch)	Length mm(inch)	Carbide height mm(inch)	(°)	Sales pkg q'ty	Part No.
★★★★☆	8	6.35	64	8	7.5	1	D-48050

## Ogee bit



Range	Shank dia. mm(inch)	Overall dia. mm(inch)	Length mm(inch)	Carbide height mm(inch)	R1 mm (inch)	Sales pkg q'ty	Part No.
★★★★☆	8	31.8	56	12.7	4.8	1	D-48773

## Slotting cutter



Range	Shank dia. mm(inch)	Overall dia. mm(inch)	Length mm(inch)	Carbide height mm(inch)	Note	Sales pkg q'ty	Part No.
★★★★☆	8	47.6	59	2	With Arbor	1	D-48941
	8	47.6	59	4		1	D-48979

# ACCESSORIES

## Outdoor Power Equipment



# Outdoor Power Equipment

## Earth auger drill bit with adapter D shank



Suitable for drilling sandy soil and soil which contains grassroots and pebbles. Used for topdressing · tree planting to fruit trees and also for drilling prepared hole which needs for hammering in various types of pile.

### Earth auger drill bit

Diameter	Length	Working Length	Part No.
ø100 mm	800 mm	550 mm	E-07294
ø150 mm			E-07303
ø200 mm			E-07319

Earth auger drill bit extension bar (540mm) E-07325

Pin for earth auger drill E-07331

Use with bit adapter Type D 327687-6

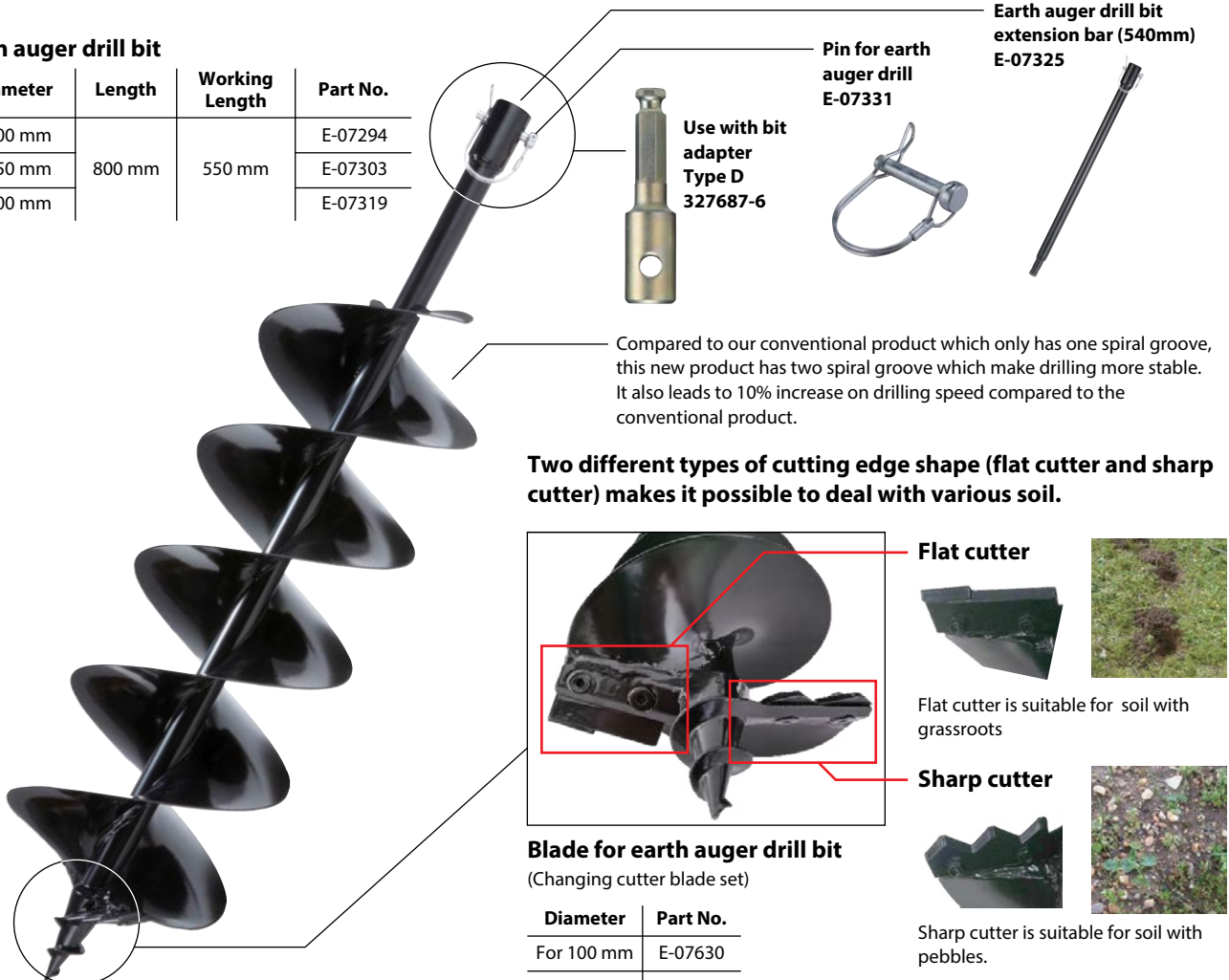

Compared to our conventional product which only has one spiral groove, this new product has two spiral groove which make drilling more stable. It also leads to 10% increase on drilling speed compared to the conventional product.

**Two different types of cutting edge shape (flat cutter and sharp cutter) makes it possible to deal with various soil.**

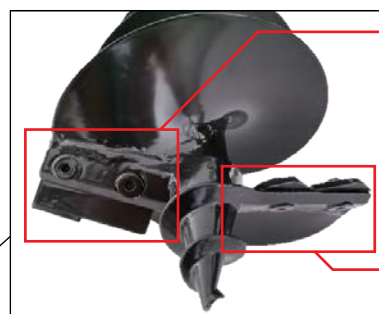

**Flat cutter**



Flat cutter is suitable for soil with grassroots

**Sharp cutter**

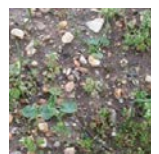

Sharp cutter is suitable for soil with pebbles.

**Blade for earth auger drill bit**  
(Changing cutter blade set)













Diameter	Part No.
For 100 mm	E-07630
For 150 mm	E-07646
For 200 mm	E-07652

\*Diameter 200mm is used only for sandy soil.



# Outdoor Power Equipment

## Blade selection guide

Blade type / Image				
		Short and soft grass	Tall and hard grass	Bush including tree beginning to grow
Nylon cord		←————→		
Plastic blade		←————→		
Metal blade		←————→		
		←————→		
		←————→		
Brushcutter blade		←————→		
Shredder blade		←————→		
Saw blade		←————→		
Chisel blade		←————→		
T.C.T. saw blade		←————→		



# Outdoor Power Equipment

Shape	Application	Blade Dia. / No. of Teeth	Thickness	Model	Part No.
80-tooth blade					
	for bushes and thin tree trunks Not available in some countries due to local regulation	255mm / 80	2.0mm	EBH340U/R, EBH341L/U/R, EM3400U/L, EM4350UH/LH/RH, EM4351UH, RBC411U, RBC412U, RBC413U, RBC414U	B-14168

TCT Saw blade					
	for gnarled bushes and thin tree trunks Not available in some countries due to local regulation	230mm / 36	1.25mm	EBH252U, EBH253U, EBH340U/R, EBH341U/L, EBH341R, EM2500U/L, EM2510LH, EM2511LH, EM2600U/L, EM2650L/U, EM2651L/U, EM2653LH, EM2654LH, EM4340L	D-65981
		250mm / 40	1.25mm	EBH340U/R, EBH341L/U/R, EM2901LH/UH, EM2904LH, EM3400U/L, EM4350UH/LH/RH, EM4351UH, RBC411U, RBC412U, RBC413U, RBC414U	A-48337
		255mm / 4	2.0mm	EBH340U/R, EBH341L/U/R, EM4350UH/LH/RH, EM4351UH, RBC411U, RBC412U, RBC413U, RBC414U	B-14124



## Edger blade



Blade Dia. / No. of Teeth	Thickness	Model No.	Part No.
203mm / 2	2.5mm	EE2650H, EE400MP	196745-7

## Brushcutter blades

Hole Dia.: 25.4mm

Shape	Application	Blade Dia. / No. of Teeth	Thickness	Model	Part No.
2-tooth blade					
	for tall grass and scrub	230mm / 2	2.0mm	EBH252U, EBH253U, EM2500U/L, EM2510LH, EM2511LH, EM2600U/L, EM2650LH/UH, EM2651LH/UH, EM2653LH, EM2654LH, EM400MP, EM401MP, EM402MP, EM403MP, EM404MP	D-66058
4-tooth blade					
	for tall grass and scrub	230mm / 4	1.8mm	DUR361U, DUR362U, EBH252U, EBH253U, EM2500U/L, EM2510LH, EM2511LH, EM2600U/L, EM2650LH/UH, EM2651LH/UH, EM2653LH, EM2654LH, EM400MP, EM401MP, EM402MP, EM403MP, EM404MP	B-14118
		230mm / 4	1.8mm	DUR365U, DUR368A/L, DUR369A/L, UR101C, UR201C, EM401MP, EM402MP	D-66008
		255mm / 4	2.0mm	EBH340U/R, EBH341L/U/R, EM4350UH/LH/RH, EM4351UH, RBC411U, RBC412U, RBC413U, RBC414U	B-14124
8-tooth blade					
	for thick grass and scrub	255mm / 8	2.0mm	EBH340U/R, EBH341L/U/R, EM3400U/L, EM4350UH/LH/RH, EM4351UH, RBC411U, RBC412U, RBC413U, RBC414U	B-14146

# Outdoor Power Equipment

## String trimmer head

(for grass, light weeds)  
\* with adapter (Poly bag with header)

### Quick loading Trimmer Head (UN-74L, UN-72L, 96-M8L/R, 96-M10L, 121-M10L)

Nylon cord can be feeded without opening the head



0 85(sec.)



0 35(sec.)



**Up to 58% less feeding time!**

Shape	Ref	Size	Thread Size	Model No.	Cord/Line	Package	Part No.
	UN-74L	4.4"	M10x1.25LH	DUR190L, DUR366L, DUR368A, DUR368L, DUR369A, DUR369L, DUR369N, EBH252U/L, EBH253U/L, EBH341U, EM3400L, EM2510LH, EM2511LH, EM2650UH/LH, EM2651UH/LH, EM2653LH, EM2654LH, UR002G, UR003G, UR101C, UR201C, UR202C, EM400MP, EM401MP, EM403MP, EM404MP, EM405MP, EM406MP	2.4mm x 3.6m	-	196324-1

Shape	Ref	Size	Thread Size	Model No.	Cord/Line	Package	Part No.
	96-M8L	4"	M8x1.25LH	DUR142L, DUR142U, DUR143U, DUR182L, DUR182U, DUR183L, DUR183U, DUR187L, DUR187U, DUR188L, DUR188U	2.0mm x 4m	Carton box	191D91-7
	96-M8R		M8x1.25RH	DUR189, DUR364	2.0mm x 4m	Carton box	191D92-5
	96-M10L	4"	M10x1.25LH	DUR190L, DUR190U, DUR191L, DUR191U, DUR192L, UR201C, UR202C, DUR365, DUR366, DUR368A, DUR368L, DUR369A, DUR369L, DUR369N, EM408MP, EM409MP, UR001G, UR002G, UR003G, UR004G, UR101C	2.0mm x 4m	Carton box	191D89-4
				DUR369A, DUR369L, DUR369N, EBH252L, EBH252U, EBH253L, EBH253U, EM2510L, EM2511L, EM2650U, EM2651L, EM2651U, EM2653L, EM2654L, EM400MP, EM401MP, EM403MP, EM404MP, EM405MP, EM406MP, UR101C, UR201C, UR202C	2.4mm x 3m	Carton box	191D90-9
	21-M10L	5"	M10x1.25LH	EBH341L, EBH341U, EM4350L, EM4350R, EM4350U, EM4351U, MS335C, RBC411, RBC412U, RBC413U, RBC414U	2.4mm x 4m	Carton box	191D93-3

# Outdoor Power Equipment

Shape	Ref	Size	Thread Size	Model No.	Cord/Line	Package	Part No.	
<b>Bump &amp; Feed (Flat type)</b>								
	-	4"	M10x1.25LH	Grass Trimmers	2.0mm x 3m	Carton box	1914R8-6	
					2.4mm x 3m		1914R6-0	
<b>Bump &amp; Feed</b>								
	76-M8R	3"	M8x1.25RH	UR100D	1.65mm x 8m	Poly bag with header	198854-8	
	95-M10L	4"	M10x1.25LH	DUR190L, DUR190U, DUR191L, DUR191U, DUR192L, UR366L, DUR368A, DUR368L, DUR369A, DUR369L, DUR369N, EBH252U/L, EBH253U/L, EM2510LH, EM2511LH, EM2650UH/LH, EM2651UH/LH, EM2653LH, EM2654LH, UR002G, UR003G, UR101C, UR201C, UR202C, EM400MP, EM401MP, EM403MP, EM404MP, EM405MP, EM406MP, EM408MP, EM409MP	2.0mm x 3m	Poly bag with header	198892-0	
2.4mm x 3m					Poly bag with header	197804-0		
<b>Bump &amp; Feed</b>								
	B & F ECO 4R	4" Low profile	M8x1.25RH	DUR189, DUR364L	2.0mm x 3m	Poly bag with header	197297-1	
	B & F ECO 4L	4" Low profile	M10x1.25LH	DUR192L, DUR366L, DUR368A, DUR368L, DUR369A, DUR369L, DUR369N, UR002G, UR003G, UR101C, UR201C, UR202C, EM408MP, EM409MP		Poly bag with header	197296-3	
	B & F Z5L	5"	M10x1.25LH	EBH252U/L, EBH253U/L, EM2510LH, EM2511LH, EM2650UH/LH, EM2651UH/LH, EM2653L, EM2654L, EM3400U/L, EBH340U, EBH341U/L/R, EM4350UH/LH/RH, EM4351UH, RBC411U, RBC412U, RBC413U, RBC414U, EM400MP, EM401MP, EM403MP, EM404MP, EM405MP, EM406MP	2.4mm x 3m	Blister pack	B-05131	
<b>Automatic feed and Bump &amp; Feed</b>								
	Line will be feeded about 3cm, in either one of the following cases -Head rotation are reached at 8,500rpm. -Bottom of the head is bumped on the ground when it is spinning.	Ultra Auto 4R	4"	M8x1.25RH	ER2550L, ER2650L, ER2600L, ER400MP	2.4mm x 3m	Carton box	B-03006
		Ultra Auto 4L	4"	M8&10x1.25 LH	DUR187U/L, DU188U/L, EM2500U/L, EM2600U/L, EBH252U/L, EBH253U/L, EM2510LH, EM2511LH, EM2650UH/LH, EM2651UH/LH, EM2653LH, EM2654LH, EM400MP, EM401MP, EM403MP, EM404MP, EM405MP, EM406MP	2.4mm x 3m	Carton box	*B-02945

## Cordless string trimmer

Model No.	Spindle Size	Receive Washer		Grass Guard for Receive Washer
		Size (mm)	Part No.	
DUR184L	M8x1.25RH	36.5	326683-1 144512-4	346857-8
DUR187L	M10x1.25LH	36.5	144512-4	346857-8
DUR189	M8x1.25RH	36.5	144512-4	346857-8
DUR192L, DUR190	M10X1.25LH	36.5	140W47-1	346857-8

Model No.	Spindle Size	Receive Washer		Grass Guard for Receive Washer
		Size (mm)	Part No.	
DUR364L	M8x1.25RH	44	319245-2	346857-8
DUR365U, DUR366L	M10x1.25LH	42	326518-6 140L84-9	346622-5
DUR368L	M8x1.25RH	-	140L84-9	-
DUR369L	M10X1.25LH	64.5	144312-2	-
UR202C	M10X1.25LH	65	140N88-3	-

# Outdoor Power Equipment

## Line character

Shape	Sharpness	Energy Saving	Quietness
Four-leaf 	A	AA	AA

## Four-Leaf Line



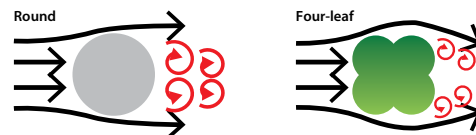



Low noise and energy saving



Four-leaf shape makes small vortex and realizes low noise and energy saving feature thanks to less air resistance.



## Color chart



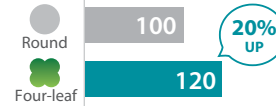

Dia.	Color / Shape	Light duty		Heavy duty	
		Short grass		Tall grass	
		Low density	High density	Low density	High density
1.3mm		↔			
1.6mm - 1.65mm		↔			
2.0mm			↔		
2.4mm				↔	
2.7mm					↔
3.0mm					↔

The amount of cutting per 1 charge

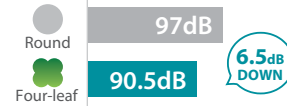

Noise





Color / Shape	Layer	Dia. (mm)	Length(m)	Part No.
	Single	1.65	15	E-01731
	Single	2	15	E-01769
	Single	2	30	197473-7 E-01775
	Single	2	310	E-01781
	Single	2.4	15	198501-1 E-01797
	Single	2.4	30	198502-9 E-01806
	Single	2.4	225	E-01812
	Single	2.7	15	E-01828
	Single	2.7	30	E-01834
	Single	2.7	180	E-01840

## Other Nylon cord (round, natural)





Size	Part No.
1.65mmx15m	DA00000003
2.4mmx5m	B-01971
3.0mmx4m	B-07375

## Protection guard

Shape	Type	Model No.	Description	Part No.
Protector 	Universal	DUR369A , DUR369L, UR101C, UR201C	With protector extension	191B54-1
for Cutting blade 	Exclusive	EBH340R	-	XNR0000302
for Trimmer head 	Exclusive	UR100D	With cord/line cutter	135950-1
		DUR189	Without cord/line cutter	456651-1
		EM405MP, EM406MP, UR101C, UR201C, UR202C, DUR369A, DUR369L, DUR369N	Narrow type / Without cord/line cutter	457273-0

# Outdoor Power Equipment

## Protection guard- Plastic blade set



	Model No.	Plastic Blade Set			Replacement Plastic Blade	
		Arbore Size	Cutting Width	Part No.	Per Pkg.	Part No.
 X5	UR100D	M8x1.25RH	230mm	198848-3	5	198850-6
 X12	DUR369A, DUR369L, DUR369N, UR101C, UR201C, UR202C	M10x1.25LH	305mm	199868-0	12	199870-3

## Spool assembly



Model No.	Part No.
UR3000	DA00000001
DUR181	195858-1
DUR193	191Y39-5

## Shoulder strap assembly

Shape	Model No.	Part No.
Singlet		
	DUN500W DUN501W, DUR181, DUR184L, DUR187L, DUR188L, DUR189, DUR190L, DUR191L, DUR364L, DUR368A, DUR368L, UR100D, UR180D, DUR366L, DUX60L, EBH252L, EBH253L, EBH341L, EM2510LH, EM2511LH, EM2650LH, EM2651LH, EM2653LH, EM2654LH, EM3400L, EN4950H, EN4951SH, EY2650H ,EX2650LH, RBC411U, RBC412U	125516-5
	DUR192L, DUR194, UR002G, UR003G; UR006G, UR007G, DUR193, DUR194, UX18D	127508-0
Comfort		
	DUR369A, EBH252U, EBH253U, EBH341U, EM2650UH, EM2651UH, EM4350UH, RBC411U, RBC412U, RBC413U, RBC414U, UR002G	122906-3

# Outdoor Power Equipment

## String trimmer harness for PDC01 & PDC1200



Item	Part No.
A	191E43-4
B	197243-4

## Attachments for loop handle brushcutter

Do not use following attachments with DUR369L, DUR369N, UR201C & UR202C.

Shape	Model No.	Part No.
<b>Hedge trimmer</b> Blade length: 490mm	EM2650LH, EM2651LH, EM2653LH, EN2654LH	198579-4
<b>Pole saw</b> Bar length: 25cm (10") Saw chain: 91VXL-39links Motor Mount:A218	EM2650LH, EM2651LH.	A-89539
<b>Coffee harvester</b>	EM2651LH	B-80210

## Attachments for back pack brushcutter

Do not use following attachments with DUR369L, DUR369N, UR201C & UR202C.

Shape	Model No.	Part No.
<b>Coffee harvester</b>	EBH340R, EBH341R	B-80226
<b>Coffee harvester</b>	EBH340R, EBH341R	197163-2



## Multi-tool attachments

Shape	Model No.	Part No.
<b>Brushcutter</b> Cutting width: 420mm Spindle size: M10 x 1.25LH	EX2650LH	EM400MP 195658-9
<b>Grass trimmer</b> Spindle size: M10 x 1.25LH	DUX18, DUX60, EX2650LH, UX01G	EM408MP 191N35-7 EM409MP 191N48-8
<b>String trimmer</b> Cutting width: 410mm Spindle size: M8 x 1.25RH	EX2650LH	ER400MP 195530-5
<b>Brushcutter</b> Blade size: 230mm Spindle size: M10 x 1.25LH	DUX60, EX2650LH	EM402MP 195952-9
<b>Rotary scissors</b> Blade size: 230mm Spindle size: M8 x 1.25 LH	DUX60, EX2650LH	EM407MP 191M60-2

## Blower

Shape	Model No.	Part No.
	DUX18, DUX60, EX2650LH, UX01G	UB401MP 191P78-1

# Outdoor Power Equipment

## Pole saw

\*Except for European, Austrarian, New zealand, Chinese & Korean markets .

Shape	Model No.	Part No.
	DUX18, DUX60, EX2650LH, UX01G	EY403MP 191T41-8

Bar length: 25cm (10") (EY401MP), 30cm (12") (EY403MP)  
Saw chain: 91VXL-39links  
Motor Mount:A218

## Pole hedge trimmer

Shape	Model No.	Part No.
	DUX18, DUX60, EX2650LH, UX01G	EN401MP 196341-1

Angle adjustment

Straight

	DUX18, DUX60, EX2650LH, UX01G	EN410MP 197742-6
---	-------------------------------	------------------

Ground trimmer.25LH

	DUX18, DUX60, EX2650LH, UX01G	EN420MP 198061-3
---	-------------------------------	------------------

## Ground Trimmer

	DUX18, DUX60, UX01G	EN424MP 1913D3-2
---	---------------------	------------------

## Cultivator

Cultivating width: 160mm

	DUX18, DUX60, EX2650LH, UX01G	KR400MP 195712-9 / 195716-1
---	-------------------------------	-----------------------------

## Cultivator

Cultivating width: 220mm

\* Rotor LR set:  
P/N:199204-0

	DUX18, DUX60, EX2650LH, UX01G	KR401MP 199185-8
---	-------------------------------	------------------

Shape	Model No.	Part No.
	DUX18, DUX60, EX2650LH, UX01G	BR400MP 199323-2

## Power brush

\* Brush wheel (1pc)  
P/N: XNR0000548

	DUX18, DUX60, EX2650LH, UX01G	SW400MP 199344-4
--	-------------------------------	------------------

## Power sweep

\* Sweeper wheel (1pc):  
P/N: XNR0000549

	DUX18, DUX60, EX2650LH, UX01G	EJ400MP 195726-8 / 197163-2
--	-------------------------------	-----------------------------

## Coffee harvester

	DUX18, DUX60, EX2650LH, UX01G	EE400MP 196750-4
---	-------------------------------	------------------

## Edger attachment

	DUX18, DUX60, UX01G	PF400MP A-75384
--	---------------------	-----------------

## Pump attachment

	DUX18, DUX60, EX2650LH, UX01G	LE400MP 191E23-0
--	-------------------------------	------------------

## Shaft extension attachment

S For Pole saw, Pole hedge trimmer and Coffee harvester





# Outdoor Power Equipment

## Saw Chain and Guide Bar

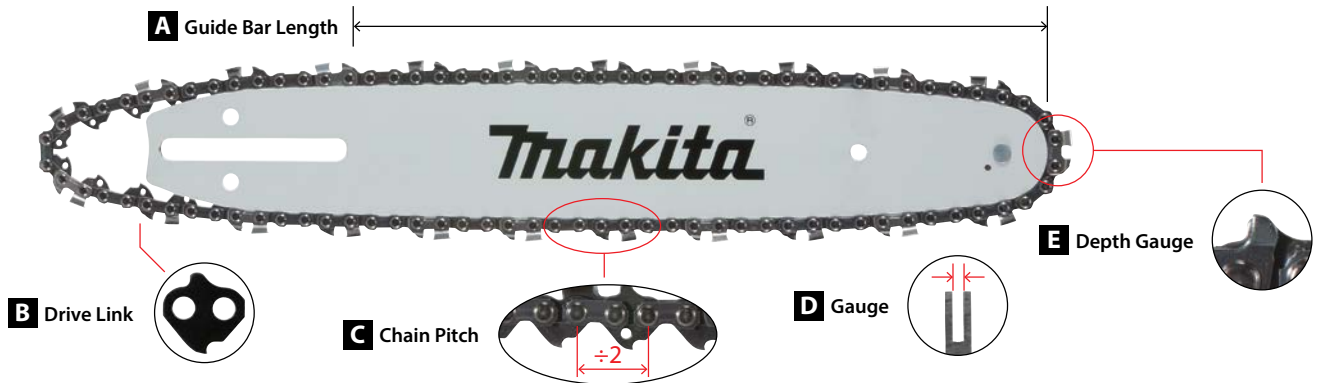

### A Guide Bar Length

Guide bar's length is represented by cutting length, which is different from its whole length.



### B Drive Link

The length of saw chain is determined by counting the number of drive links in the saw chain.

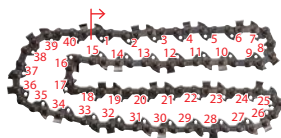

### C Chain Pitch

Chain pitch is the size of the chain and it is defined by the distance between any three consecutive rivets divided by two. Pitch is important because the drive sprocket must be the same pitch as the chain.



### D Gauge

Chain Gauge is thickness of drive link which will fit into the guide bar groove. Chain gauge must be the same as guide bar gauge.

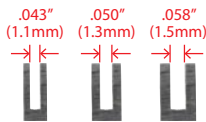

### E Depth Gauge

Depth gauge determines how deep the cutting teeth gets into the wood. Cutting depth can be checked by the gap between top of cutter and depth gauge.



## General Saw Chain Character

D Gauge	Cutting speed			
	Fast			Slow
C Chain Pitch	.043" (1.1mm)	.050" (1.3mm)	.058" (1.5mm)	.063" (1.6mm)
Surface condition	1/4"	25AP		
	.325"LP	80TXL		
	3/8"LP	90PX	91PX 91VXL	
	.325"	20BPX 95VPX	21BPX 21LPX	22LPX
	3/8"	72V	73DPX 73LGX 73LPX	
.404"			27X	

## Guide Bar Type

### Sprocket Nose Bars

Sprocket nose bars have a rotating sprocket mounted at the tip of the bar. As the chain moves along the bar, the sprocket teeth carry the chain around the tip smoothly with less friction.



### High durability sprocket nose bar

Longer nose life thanks to larger nose sprocket than normal sprocket bars. Multiple rivets can be found on bar surface.



### Solid Carving Bars

Carving bars are made of high-quality steel and high wear resistant stellite has been welded onto the tip. Bar tip is designed to have small radius for precision cutting. The carving bars are made for especially pruning and carving.



## Guide Bar Maintenance

### Chain Tension

Check the chain tension before use. The saw chain may become loose after many hours of use.



### File Bar Edge

File bar edge with a flat file to keep it 90° once a week.



### Clean Guide Bar

Clean out chips and sawdust every time when you sharpen or replace saw chain.



### Bar Nose Grease

Lubricate a whole sprocket regularly so that the saw chain can rotate with less friction.

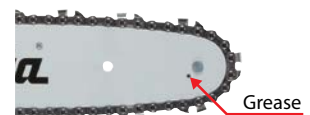

# Chainsaw Accessories

## Chain Saws

### Guide Bar / Saw Chain / Guide Bar Cover / Drive sprocket

Cutter type: CC: Chamfer chisel, SC: Semi chisel, MC : Micro chisel, FC: Full chisel

\* Pole saw attachment (196315-2)

\*\*without package

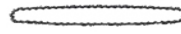

Model No.	Guide Bar					Saw Chain					Bar Cover	Drive sprocket	
	Bar length	Motor Mount	Type	Part No.	No. of drive links	Gauge	Pitch	Type OREGON	Cutter type	Part No. (Carton)	Part No.	Type	Part No.
<b>Pole Saws</b>													
EY401MP	25cm/10"	A218	Sprocket nose bar	191G11-9	39	1.3mm/.050"	3/8" LP	91VXL	SC	191H20-4	452093-7 / 458501-6	3/8"LP	XTM0000014
EY402MP EY403MP DUA250, DUA251 DUA300, DUA301 UA001G, UA002G UA003G, UA004G	25cm/10"	A041	Sprocket nose bar	191G14-3	40	1.1mm/.043"	3/8" LP	90PX	CC	191H00-0	452093-7 / 458501-6	3/8"LP	226992-7
	30cm/12"	A041		191G15-1	46					191H01-8	419288-5 / 413G23-5		
	25cm/10"	A041		191G22-4	40	1.3mm/.050"	91PX	CC	191H08-4	452093-7 / 458501-6			
	30cm/12"	A041		191G23-2	46				191H10-7	419288-5 / 413G23-5			
<b>Cordless Chain Saws</b>													
DUC101 UC100D	10cm/4"	—	without sprocket	1910W0-3	26	1.1mm/.043"	.325" LP	80TXL	MC	1910V6-4	413M40-1	.325"LP	227947-5
DUC121, DUC122	11.5cm/4-1/2"	—	without sprocket	158476-6	42	1.3mm/.050"	1/4"	25AP	MC	191G95-7	416311-7	1/4"	221527-9
DUC204 DUC254 DUC254C	25cm/10"	—	Solid carving bar	1911A1-3	60	1.3mm/.050"	1/4"	25AP	MC	-	452093-7 / 458501-6	1/4"	198259-2
	25cm/10"	A041	Sprocket nose bar	191T85-8	46	1.1mm/.043"	.325" LP	80TXL	MC	191T89-0	452093-7 / 458501-6	.325"LP	1911W6-9
	30cm/12"	A041		191T86-6	51					191T90-5	419288-5 / 413G23-5		
	20cm/8"	A041	Sprocket nose bar	191G13-5	33	1.1mm/.043"	3/8" LP	90PX	CC	191G99-9	458503-2	Sprocket 3/8"LP	199063-2
	25cm/10"	A041		191G14-3	40					191H00-0	452093-7 / 458501-6		
	30cm/12"	A041		191G15-1	46					191H01-8	419288-5 / 413G23-5		
	25cm/10"	A041	Sprocket nose bar	191G22-4	40	1.3mm/.050"	3/8" LP	91PX	CC	191H08-4	452093-7 / 458501-6	Sprocket 3/8"LP	199063-2
30cm/12"	A041	191G23-2		46	191H10-7					419288-5 / 413G23-5			
DUC252 DUC302 DUC352 DUC252C	25cm/10"	—	Solid carving bar	1911A1-3	60	1.3mm/.050"	1/4"	25AP	MC	-	452093-7 / 458501-6	Sprocket 1/4"	221528-7
	25cm/10"	A041	Sprocket nose bar	191G14-3	40	1.1mm/.043"	3/8" LP	90PX	CC	191H00-0	452093-7 / 458501-6	Sprocket 3/8"LP	221526-1
	30cm/12"	A041		191G15-1	46					191H01-8	419288-5 / 413G23-5		
	35cm/14"	A041	Sprocket nose bar	191G16-9	52	1.3mm/.050"	3/8" LP	91PX	CC	191H02-6	419288-5 / 413G23-5	Sprocket 3/8"LP	221526-1
	25cm/10"	A041		191G22-4	40					191H08-4	452093-7 / 458501-6		
	30cm/12"	A041		191G23-2	46					191H10-7	419288-5 / 413G23-5		
35cm/14"	A041	191G24-0	52	191H11-5	419288-5 / 413G23-5								
DUC256 DUC306 DUC356 DUC406 DUC256C	25cm/10"	—	Solid carving bar	191G61-4	60	1.3mm/.050"	1/4"	25AP	MC	-	452093-7 / 458501-6	Sprocket 1/4"	198259-2
	25cm/10"	A041	Sprocket nose bar	191T85-8	46	1.1mm/.043"	.325" LP	80TXL	MC	191T89-0	452093-7 / 458501-6	Sprocket .325"LP	1911W6-9
	30cm/12"	A041		191T86-6	51					191T90-5	419288-5 / 413G23-5		
	35cm/14"	A041	Sprocket nose bar	191T87-4	59	1.1mm/.043"	3/8" LP	90PX	CC	191T91-3	419288-5 / 413G23-5	Sprocket 3/8"LP	199063-2
	25cm/10"	A041		191G14-3	40					191H00-0	452093-7 / 458501-6		
	30cm/12"	A041		191G15-1	46					191H01-8	419288-5 / 413G23-5		
	35cm/14"	A041	Sprocket nose bar	191G16-9	52	1.1mm/.043"	3/8" LP	90PX	CC	191H02-6	419288-5 / 413G23-5	Sprocket 3/8"LP	199063-2
	40cm/16"	A041		191G17-7	56					191H03-4	419242-9 / 413G21-9		
	25cm/10"	A041	Sprocket nose bar	191G22-4	40	1.3mm/.050"	3/8" LP	91PX	CC	191H08-4	452093-7 / 458501-6	Sprocket 3/8"LP	199063-2
	30cm/12"	A041		191G23-2	46					191H10-7	419288-5 / 413G23-5		
35cm/14"	A041	191G24-0		52	191H11-5					419288-5 / 413G23-5			
40cm/16"	A041	191G25-8		56	191H12-3					419242-9 / 413G21-9			
DUC307 DUC357 DUC407	30cm/12"	A041	Sprocket nose bar	191G15-1	46	1.1mm/.043"	3/8" LP	90PX	CC	191H01-8	419288-5 / 413G23-5	Sprocket 3/8"LP	199063-2
	35cm/14"	A041		191G16-9	52					191H02-6	419288-5 / 413G23-5		
	40cm/16"	A041	Sprocket nose bar	191G17-7	56	1.3mm/.050"	3/8" LP	91PX	CC	191H03-4	419242-9 / 413G21-9	Sprocket 3/8"LP	199063-2
	30cm/12"	A041		191G23-2	46					191H10-7	419288-5 / 413G23-5		
	35cm/14"	A041		191G24-0	52					191H11-5	419288-5 / 413G23-5		
40cm/16"	A041	191G25-8	56	191H12-3	419242-9 / 413G21-9								
DUC303 DUC353 DUC400 DUC305 DUC355 DUC405	25cm/10"	—	Solid carving bar	1911A1-3	60	1.3mm/.050"	1/4"	25AP	MC	-	452093-7 / 458501-6	Sprocket 1/4"	198259-2
	30cm/12"	A041	Sprocket nose bar	191T86-6	51	1.1mm/.043"	.325" LP	80TXL	MC	191T90-5	419288-5 / 413G23-5	Sprocket .325"LP	1911W6-9
	35cm/14"	A041		191T87-4	59					191T91-3	419288-5 / 413G23-5		
	40cm/16"	A041	Sprocket nose bar	191T88-2	64	1.1mm/.043"	3/8" LP	90PX	CC	191T92-1	419242-9 / 413G21-9	Sprocket 3/8"LP	199063-2
	30cm/12"	A041		191G15-1	46					191H01-8	419288-5 / 413G23-5		
	35cm/14"	A041		191G16-9	52					191H02-6	419288-5 / 413G23-5		
	40cm/16"	A041	Sprocket nose bar	191G17-7	56	1.1mm/.043"	3/8" LP	90PX	CC	191H03-4	419242-9 / 413G21-9	Sprocket 3/8"LP	199063-2
	30cm/12"	A041		191G23-2	46					191H10-7	419288-5 / 413G23-5		
35cm/14"	A041	Sprocket nose bar	191G24-0	52	1.3mm/.050"	3/8" LP	91PX	CC	191H11-5	419288-5 / 413G23-5	Sprocket 3/8"LP	199063-2	
40cm/16"	A041		191G25-8	56					191H12-3	419242-9 / 413G21-9			

# Chainsaw Accessories

Model No.	Guide Bar					Saw Chain					Bar Cover	Drive sprocket	
	Bar length	Motor Mount	Type	Part No.	No. of drive links	Gauge	Pitch	Type OREGON	Cutter type	Part No. (Carton)	Part No.	Type	Part No.
UC002G UC003G UC004G UC006G UC007G	25cm/10"	—	Solid carving bar	1911A1-3	60	1.3mm/.050"	1/4"	25AP	MC	-	452093-7 / 458501-6	Sprocket 1/4"	191V92-3
	25cm/10"	A041	Sprocket nose bar	191T85-8	46	1.1mm/.043"	.325" LP	80TXL	MC	191T89-0	452093-7 / 458501-6	Sprocket .325"LP	191V91-5
	30cm/12"	A041		191T86-6	51					191T90-5	419288-5 / 413G23-5		
	35cm/14"	A041		191T87-4	59					191T91-3	419288-5 / 413G23-5		
	25cm/10"	A041	Sprocket nose bar	191G14-3	40	1.1mm/.043"	3/8" LP	90PX	CC	191H00-0	452093-7 / 458501-6	Sprocket 3/8"LP	191V90-7
	30cm/12"	A041		191G15-1	46					191H01-8	419288-5 / 413G23-5		
	35cm/14"	A041		191G16-9	52					191H02-6	419288-5 / 413G23-5		
	25cm/10"	A041	Sprocket nose bar	191G22-4	40	1.3mm/.050"	3/8" LP	91PX	CC	191H08-4	452093-7 / 458501-6	Sprocket 3/8"LP	191V90-7
	30cm/12"	A041		191G23-2	46					191H10-7	419288-5 / 413G23-5		
	35cm/14"	A041		191G24-0	52					191H11-5	419288-5 / 413G23-5		
UC010G UC011G UC012G UC013G UC014G UC015G UC016G UC017G UC020G	30cm/12"	A041	Sprocket nose bar	191T86-6	51	1.1mm/.043"	.325" LP	80TXL	MC	191T90-5	419288-5 / 413G23-5	Sprocket .325"LP	191V91-5
	35cm/14"	A041		191T87-4	59					191T91-3	419288-5 / 413G23-5		
	40cm/16"	A041		191T88-2	64					191T92-1	419242-9 / 413G21-9		
	45cm/18"	A041	Sprocket nose bar	191X03-0	70	1.1mm/.043"	3/8" LP	90PX	CC	191X04-8	419242-9 / 413G21-9	Sprocket 3/8"LP	191V90-7
	30cm/12"	A041		191G15-1	46					191H01-8	419288-5 / 413G23-5		
	35cm/14"	A041		191G16-9	52					191H02-6	419288-5 / 413G23-5		
	40cm/16"	A041	Sprocket nose bar	191G17-7	56	1.3mm/.050"	3/8" LP	91PX	CC	191H03-4	419242-9 / 413G21-9	Sprocket 3/8"LP	191V90-7
	30cm/12"	A041		191G23-2	46					191H10-7	419288-5 / 413G23-5		
	35cm/14"	A041		191G24-0	52					191H11-5	419288-5 / 413G23-5		
	40cm/16"	A041	Sprocket nose bar	191G25-8	56	1.3mm/.050"	3/8" LP	91PX	CC	191H12-3	419242-9 / 413G21-9	Sprocket 3/8"LP	191V90-7
45cm/18"	A041	191G26-6		62	191H13-1					419242-9 / 413G21-9			

## Electric Chain Saws

UC3041A, UC3541A, UC4041A	30cm/12"	A041	Sprocket nose bar	191G15-1	46	1.1mm/.043"	3/8" LP	90PX	CC	191H01-8	419288-5 / 413G23-5	Sprocket 3/8"LP	221526-1
	35cm/14"	A041		191G16-9	52					191H02-6	419288-5 / 413G23-5		
	40cm/16"	A041		191G17-7	56					191H03-4	419242-9 / 413G21-9		
	30cm/12"	A041	Sprocket nose bar	191G23-2	46	1.3mm/.050"	3/8" LP	91PX	CC	191H10-7	419288-5 / 413G23-5	Sprocket 3/8"LP	221526-1
	35cm/14"	A041		191G24-0	52					191H11-5	419288-5 / 413G23-5		
	40cm/16"	A041		191G25-8	56					191H12-3	419242-9 / 413G21-9		
UC3050A, UC3550A, UC4050A, UC4550A, UC3051A, UC3551A, UC4051A, UC4551A	30cm/12"	A041	Sprocket nose bar	191G23-2	46	1.3mm/.050"	3/8" LP	91PX	CC	191H10-7	419288-5 / 413G23-5	Sprocket 3/8"LP	221521-1
	35cm/14"	A041		191G24-0	52					191H11-5	419288-5 / 413G23-5		
	40cm/16"	A041		191G25-8	56					191H12-3	419242-9 / 413G21-9		
	45cm/18"	A041		191G26-6	62					191H13-1	419242-9 / 413G21-9		

## Petrol Chain Saws

For Models	Guide Bar			Saw Chain					Bar Cover Part No.	File diameter, 1st half of top plate	File diameter, 2nd half of top plate	Type
	Bar length	Part No.	No. of drive links	gauge	pitch	Cutter type	Saw Chain Part No.					
EA6100, EA7900, DCS6400, DCS6401, DCS6400H, DCS7300, DCS7300H, DCS7301, DCS7900, DCS7900H, DCS7901, PS7300, PS7900	50cm/20"	-	72	1.5mm/0.058"	3/8"	73LP	FC	528 099 672	-	5.5mm	4.8mm	-
	60cm/24"	-	84					528 099 684	-			-
	60cm/24"	-	84					528 099 684	-			Solid
	70cm/28"	-	94					-	-			-
DCS9000, DCS9010, PS9010	76cm/30"	443 076 422	92	1.5mm/0.058"	3/8"	73LP	FC	528 099 696	-	5.5mm	4.8mm	-
EA4301F	45cm/18"	445 045 655	72	1.3mm/0.050"	0.325"	95VP	SC	512 484 772	-	-	-	-
DCS6000I, DCS6400, DCS6401, PS6400	50cm/20"	-	72	1.5mm/0.058"	3/8"	73LP	FC	528 099 672	-	-	-	-
DCS520, DCS6000I, 111	53cm/21"	445 053 451 443 053 651	72	1.5mm/0.058"	3/8"	73LP	FC	528 099 672	-	-	-	Solid Sprocket

Saw Chain: 14" (350mm) & 16" (400mm)  
Part No. **1914F3-2** SAW CHAIN 14" 1.1MM/.043" 3/8" SPRKT M41  
**1914F4-0** SAW CHAIN 16" 1.1MM/.043" 3/8" SPRKT M41

Model No. DUC, UC series.



# Outdoor Power Equipment

## Bar nut



\* Pole saw attachment (196315-2)

Model No.	Thread Size	Wrench Size	Part No.
EA4300F, EA5001P, EA5000P, EA6100P, EA6101P, EA7300P, EA7301P, EA7900P, EA7901P	Single	2	252145-2

## Round File, File holder

For Model:  
Chain saw  
\* with handle



Saw Chain Type	Size	Round File		File and File Handle and File Holder
		Part No.	Q'ty	Part No.
25F, 25AP, 91P, 91PX, 91PXL, 91VXL, M91VXL, 466, 492, 196	4mm	*744003-1	1	-
		953003090	1	953003010
		D-67365	12	D-70948
90PX, 90SG, 291	4.5mm	953003100	1	195923-6
		-	-	D-70954
		-	-	-
95VPX, 95TXL, 20BPX, 21BPX, 22BPX, 20LPX, 21LPX, 22LPX, 082, 086, 686, 484	4.8mm	953003070	1	-
		-	-	D-70960
		-	-	-
72DPX, 73DPX, 75DPX, 72LPX, 73LPX, 75LPX	5.2mm	D-67424	12	D-70976
72V, 73V, 75V, 72APX, 72DPX, 73DPX, 75DPX, 72EXL, 73EXL, 75EXL, 72EXJ, 73EXJ, 75EXJ, 72LGX, 73LGX, 75LGX, 72JGX, 73JGX, 75JGX, 72JPX, 73JPX, 75JPX, 72LPX, 73LPX, 75LPX, 72RD, 73RD, 75RD, 496, 093, 099	5.5mm	953003040	1	-
		-	-	D-70982
		-	-	-

## Pruning extension set

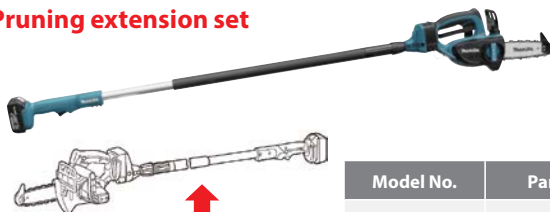

Model No.	Part No.
DUC122	195595-7

## Holster For DUC101 & UC100D

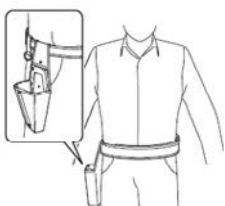

Model No.	Part No.
DUC101, UC100D	1911R0-4

## Flat File, Depth gauge



Flat file		Depth Gauge		Flat File and File Handle and Depth Gauge
Part No.	Q'ty	Part No.	Part No.	Part No.
953003060	1	953003060	-	-
-	-	-	-	D-70998



## File set for in Roll Up Pouch



For all saw chain

Description	Part No.
φ4.0mm Round File(3pcs) / File Holder / Flat File / Handle(2pcs) / Depth Gauge	D-72154
φ4.8mm Round File(3pcs) / File Holder / Flat File / Handle(2pcs) / Depth Gauge	D-72176
φ5.2mm Round File(3pcs) / File Holder / Flat File / Handle(2pcs) / Depth Gauge	D-72182
φ5.5mm Round File(3pcs) / File Holder / Flat File / Handle(2pcs) / Depth Gauge	D-72198

## Chain oil

Description	Size	Part No.
<p>Chain Oil</p>  <p>With Makita chain oil, chain oiling is formulated to adhere to the bar and chain and to reduce wear. Adhesion additive helps keep sap and pitch from clinging to the bar and chain. (Not available in Austria)</p>	100ml	199897-3
<p>BIOTOP Chain oil</p>  <p>With BIOTOP, chain oiling is safe for environment. BIOTOP is purely vegetablebased and readily biodegradable. It meets the strict requirements of the RAL UZ48 environment mark for environmental compatibility, lubrication, and aging resistance.</p>	1L	1910U0-9

# Outdoor Power Equipment

## Hook holder for extension cord



Model No.	Description	Part No.
B	Cord holder complete set	194677-2
C	Hook complete	158024-1

## Shear blade & Blade cover for Grass Shear



Model No.	Cutting Width	Blade Assembly	Blade cover	Grass Receiver
DUM111, DUM110	110mm	191N23-4	413885-9	454880-0
DUM168, DUM604, UM600D, UM603D	160mm	195267-4	452055-5	457426-1

## Conversion from Hedge Trimmer to Grass Shear

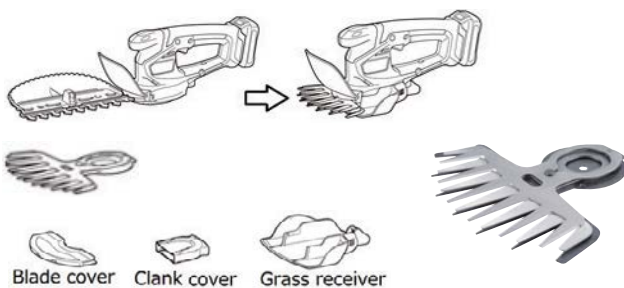

Model No.	Cutting Width	Blade assembly
UH201D	160mm	195267-4

## Grass Receiver



\*with grass Shear blade

Model No.	Part No.
DUM604, UM600D, UM603D, *UH201D	457426-1

## Blade type

### A: Curving blade

Optimum blade shape for smooth cutting

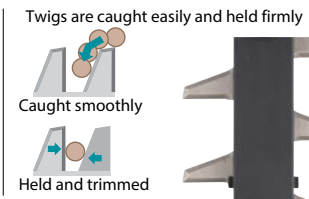
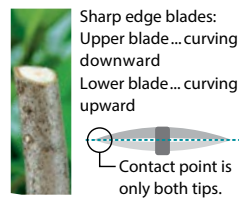

### B: High grade blade

Upper/ Lower blade teeth with 3

sharpened edges for clean cut.



Blade teeth with 3 sharpened edges Well sharpened edges provide clean cut with the least branch damage.

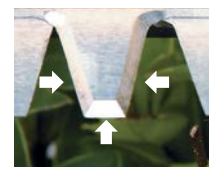

### C: Stain-free blade

Non-electrolyzed nickel plating

Evenly and strongly adhered surface coating that features high anti-abrasion surface for long lasting coating.



Sap on the blade (after 10 hour trimming of Boxwood)



Stain-free Blade



Our Current models

Model No.	Blade Assembly		Blade Cover
	Blade Type	Part No.	Part No.

Cordless Hedge Trimmer

\*for China, Hong Kong, Korea, Malaysia, Philippines, Singapore, Taiwan & Vietnam.

\*\*for Canada & Mexico

UH201D	C	EU:198408-1	458342-0
DUH551	C	196687-5	450489-6
DUH651	C	196688-3	450490-1
DUH506	C	1910H8-2	-
DUH606	C	1910H9-0	-
DUH507	C	1911J1-6	-
DUH521, DUH523U, UH520D, UH522D	C	195769-0	-
DUH501	A	-	458413-3
DUH601	A	199099-1	458414-1 *459121-9
DUH751	A	199100-2	458415-9
DUH604S	B	191D38-1	-
DUH754S	B	191D39-9	-
DUH502	B	199598-3	459120-1
UH005G	A	191R54-7	-
UH006G	A	191R55-5	-
UH007G	A	191R56-3	-
UH008G	B	191R57-1	-
UH009G	B	191R58-9	-
UH014G	B	191Y05-2	-

# Outdoor Power Equipment

Model No.	Blade Assembly		Blade Cover
	Blade Type	Part No.	Part No.

Pole Hedge Trimmer (Cordless, Petrol, Multi-tool attachments)

\*with Blade guard

\*\*without Blade guard

DUN461W, UN460WD	A	191P00-8	-
DUN500W	A	191C14-9	458413-3
DUN600L	A	191C13-1	-
EN420MP	B	198195-2	-
EN401MP, EN410MP, EN4950H, EN4951SH	B	EU:197768-8	-

AC Hedge Trimmer

UH5580	C	194671-4	-
--------	---	----------	---

Petrol Hedge Trimmer

\*for blade without end cover

\*\*for blade with end cover

EH5000W	B	123709-8	-
EH7500W	B	125857-9	-
EH6000S	B		-
EH7500S	B	125773-5	-

## Chip receiver assembly set

Keeps branch or leaf debris from scattering around.

• Attachable to either side of the blade



Model No.	Description	Part No.
DUH202, *DUM111, *DUM604, UH201D, *UM110D, *UM600D, *UM603D	One-touch installation removal	198401-5
DUH501, DUH502, DUH601, DUH602, DUH751, DUH752	One-touch installation/removal	199151-5
DUH604S	-	191D33-1
DUH754S	-	191D34-9
UH004G, UH006G, UH008G	-	191R51-3
UH005G, UH007G, UH009G	-	191R52-1

## Toothed edge

designed like saw teeth can catch and prevent leaf or twig debris from falling over the edge of chip receiver.



Anti-slide ribs on the bottom plate prevents leaf or twig debris from sliding and slipping out of chip receiver.

Model No.	Description	Content	Part No.
EH7500S, EN7350S	without blade guard	With binding head screw M5X12 x5pcs	196777-4
EH7500S, EN7350S	with blade guard	With binding head screw M5 x 12 x 5pcs.	195321-4

## Conversion from Grass Shear to Hedge Trimmer

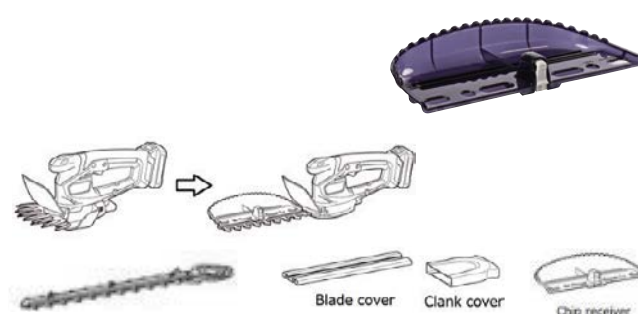

\*With clank cover

Model No.	Blade Assembly	Blade Cover	Chip Receiver
	Part No.	Part No.	Part No.
DUM604, UM600D, UM603D	198408-1	*195274-7	198401-5
DUM110, DUM111	191N24-2	458342-0	198401-5
		*195274-7	

## Blade guard



Model No.	Part No.
Cordless Hedge Trimmer	
DUH501, DUH502, DUH601, DUH602, DUH751, DUH752	458408-6

## Long attachment handle (Extension handle kit)

Photo:198486-1



\*with grass shear blade

Model No.	Part No.
DUM604, *DUH202, UM110D, DUM111, UM600D, UM603D, *UH201D	EU:198486-1

# Outdoor Power Equipment

## Pruning Shear blade

Shear blade (U)



Do not re-use Stop Ring E-4 when reassembling.

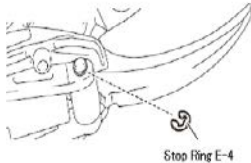

Shear blade (L)

Do not re-use Stop Ring E-4 when reassembling.  
Stop Ring E-4

\*With Stop Ring E-4 (P/N:961011-9)

\*\*Hex socket button head screw M3x6 P/N:266183-8

& Shoulder bolt M8

P/N:251573-8 are also necessary.

Model No.	Type	*Shear Blade (U)	Shear Blade (L)
		Part No.	Part No.
DUP361 DUP362	Standard	EU: 197588-0*	EU: 197367-6
	For hard branch	-	199169-6
	For thin branch	199314-3**	-

## Branch catcher set

\*with Shear blades for thin branch

Branch catcher set



Model No.	Part No.
*DUP361, *DUP362	199311-9

## Diamond file for shear blade

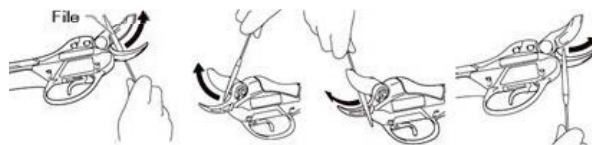

Model No.	Part No.
DUP361, DUP362	794530-8

## Wheelbarrow attachment

**Dump unit set**  
DCU603 & DCU604

**Carrier set**  
DCU180

DCU604



**Bucket set**  
DCU180

DCU603

DCU605

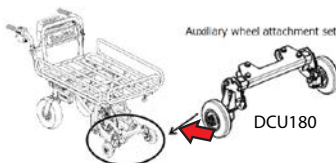

DCU180

Model No.	Type	Part No.
DCU180	Carrier set (Pipe deck)	199116-7
	Bucket set	198494-2
	Auxiliary wheel attachment set	191A01-6

## Wheelbarrow attachment

Model No.	Type	Part No.
DCU603	Dump Bucket 200 Set	191B69-8
DCU604	Carrier Set	191B67-2
DCU605	Flat Bucket Set	1911B3-6
DCU603, DCU604	Dump Unit Set	191B63-0

## Tire for Wheelbarrow



Model No.	Type	Part No.
DCU601, DCU602, DCU603, DCU604, DCU605	Tire 330 (Single) Set	1911K4-7
	Gray Tire 330 (Single) Set	1911K5-5
	Gray Tire 210 (Single) Set	1911K6-3

## Rotary lawn mower blade



Model No.	Size (mm)	Part No.
Cordless Lawn Mower		
DLM382	380	191D41-2
DLM432	430	191D43-8
DLM462, DLM465	460	191D51-9
DLM530, DLM531, DLM532, DLM536, DLM537, LM001C	530	191D52-7
Electric Lawn Mower		
ELM3320	330	YA00000745
ELM3720	370	YA00000746
ELM4121	410	YA00000738
ELM4620	460	YA00000741
ELM4621	460	YA00000741

## Rotary lawn mower swing back blade



Model No.	Swing Back Blade Set		Replacement Blade Set	
	Size (mm)	Part No.	Size (mm)	Part No.
DLM462, DLM465	460	191D49-6	4	191D47-0
DLM530, DLM531, DLM532, DLM533, DLM535, DLM536 DLM537, LM001C	530	191D50-1	4	191D48-8

# Outdoor Power Equipment

## Mulching plug set



Model No.	Part No.
DLM382 DLM432	191D46-2

## Vacuum Attachment



Model No.	Description	Part No.
DUB363	Vacuum kit set	191E19-1
BHX2500, BHX2501	Vacuum set	195282-8

## Pipe, End pipe, Flat nozzle & others accessory

\*Adapter pipe 71 set are also necessary.  
 \*\*Adapter pipe 80-72 set are also necessary.  
 \*\*\*Adapter pipe 85-72 set are also necessary.  
 \*\*\*\*Adapter pipe set MG set are also necessary.

Model No.	Items	Part No.
DUB184** DUB362 DUB363 UB001C*** UB001G**** UB400MP****	Extension Nozzle 	197888-8
DUB184** DUB362* DUB363 UB001C*** UB001G**** UB400MP**** UB401MP****	Flat nozzle 	197889-6
DUB184** DUB362* DUB363 UB001C*** UB001G**** UB400MP**** UB401MP****	Gutter nozzle set (2.9m) • Extension Pipe 72 0.9m P/N:459816-4) x3 • Nozzle P/N:162790-4) x1 • Hose Clamp 75-90 P/N:281030-2) x2 • Hose Clamp 85-100 P/N:281031-0) x1 	191B03-8
DUB362	Adapter pipe 71 set 	191J13-3
DUB184	Adapter pipe 80-72 set 	191L13-5
UB001C UB001G	Adapter pipe 85-72 set 	191L96-5
UB400MP UB401MP	Adapter pipe set MG 	191C15-7
UB001G DUB184 DUB362	Shoulder belt 	166094-6



Pipe



End nozzle



Flat nozzle



Hip belt



Sternum strap



Model No.	Items	Part No.
EB5300TH, EB5300WH, EB7660TH, EB7660WH	Long pipe 90 set	197723-0
	Short pipe 90 set	196912-4
	End nozzle 90-62	198034-6
	Flat nozzle	196911-6
PM7650H, PM7651H	Top adapter	453986-1

## Nozzle assembly

A: Standard equipment



Model No.	Size (mm)	Type	Part No.
DUB182	220	A	132025-7
UB100D, UB101D, DUB185, DUB186	220	A	123245-4
	430	-	123246-2

## Tapered Nozzle

A: Standard equipment

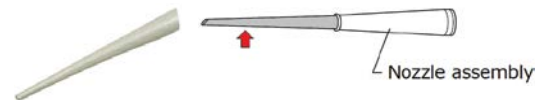

Model No.	Color	Part No.
UB100D, UB101D, DUB185, DUB186	Gray	192236-6

## Bending long nozzle set

\* long nozzle



Model No.	Part No.
DUB183/DUB182	TP00000199
UB100D, UB101D, DUB185, DUB186	191G09-6

## Dust Bag



Model No.	Part No.
UB100D, UB101D, DUB185, DUB186	123241-2

## Flexible hose set

(Total length: 95cm)













Model No.	Part No.
DUB185, DUB186, UB100D, UB101D	196643-5



# Outdoor Power Equipment

## Sprayer accessories for EF1550RH & EVH2000

Shape	Model No.	Features/ Recommended use	Part No.	
Wide angle herbicide nozzle 	EF1550RH EVH2000	for spraying herbicides; also ideal for watering plants or spraying soil conditioner	6908031000	
Herbicide nozzle 		Hard to become mist preventing diffusion of medicine.	6958011000	
Y-shaped double nozzle 		for general pesticide applications using insecticides, fungicides, etc.	6958025000	
Long two head nozzle 		Wide spraying with wide angle outlet.	6949001000	
U-shaped double nozzle 		Wide spraying with wide angle outlet.	6958018000	
Triple concentric nozzle 		Spraying in the form of circular.	6909500100	
Quadruple concentric nozzle 		Spraying in the form of circular.	6919500000	
Compact nozzle 		Convenient for spraying in the green house by compact nozzle.	6939025000	
Jet nozzle 2 		EVH2000	Diffusion or straight is selectable with one tach	6939024000
Super jet nozzle 			Diffusion or straight is selectable.	6939028000

## Power washer accessories for DHW080, HW1200, & HW1300

Shape	Model No.	Part No.
Trigger gun set 	DHW080, HW1200 HW1300, HW001G	197842-2
Variable nozzle set 	DHW080, HW1200 HW1300, HW001G	197822-8
Variospray lance set 	DHW080, HW1200 HW1300, HW001G	197876-5
Cyclone jet nozzle set 	DHW080, HW1200 HW1300, HW001G	197824-4
Cyclone guard set 	DHW080, HW1200 HW1300, HW001G	197864-2
Under body spray lance set 	DHW080, HW1200* HW1300*, HW001G (*for 110-127V)	197859-5
	DHW080, HW1200** HW1300**, HW001G (**for 220V-240V)	198909-9
Extension pipe set (0.9m / 1.3m / 1.7m) 	DHW080, HW1200 HW1300, HW001G	197870-7

Shape	Model No.	Part No.	
Rotating brush set 	DHW080, HW1200 HW1300, HW001G	197831-7	
Wash brush set 	DHW080, HW1200 HW1300, HW001G	197828-6	
Foam nozzle set 	DHW080, HW1200 HW1300, HW001G	197886-2	
Pipe cleaning hose 	DHW080, HW1200 HW1300, HW001G	10m	197837-5
		15m	197840-6
High pressure extension hose 	DHW080, HW1200 HW1300, HW001G	5m	197845-6
		8m	197847-2
		10m	197850-3
Twist prevention joint set 	DHW080, HW1200 HW1300, HW001G	197867-6	
Self-suction hose set 	DHW080, HW1200 HW1300, HW001G	197873-1	
Accessory joint set 	DHW080, HW1200 HW1300, HW001G	197853-7	
Absorption connector set 	DHW080, HW1200 HW1300, HW001G	197881-2	
One touch joint set 	DHW080, HW1200 HW1300, HW001G	197883-8	
Cleaner pin set 	DHW080, HW1200 HW1300, HW001G	197879-9	
Shoulder belt 	DHW080	162523-7	



# Outdoor Power Equipment

## Spark plug



Model No.	Wrench Size (mm)	Part No.
NGK CMR4A	16	168534-0
NGK CMR6A	16	168401-9
NGK CMR6H	16	168652-4
NGK CMR7A-5	16	168599-2
NGK BPMR7A	19	168648-5
NGK BPM7A	19	168588-7
NGK BPMR8Y	19	649500-1
NGK BMR7A	19	168662-1

## High-performance 2-stroke engine oil 50:1



Model No.	Part No.
100ml	980008606
1L	980008607

## Fuel mixture



Model No.	Part No.
1L	456236-3

## Grease vessel set



Description	Size	Part No.
For Pole hedge trimmer and Multi-tool attachments (Cultivator, Power brush and Power sweep) (GREASE NO.0)	80ml	197439-7
For string trimmer, Brushcutter and Hedge trimmer (GREASE NO.2)	80ml	199450-5



# ACCESSORIES

## ▣ Cleaning / Vacuum System



# Vacuum Cleaner System charts

## For Dust Collecting

\*for Model DVC261, DVC265, DVC660, DVC665 only

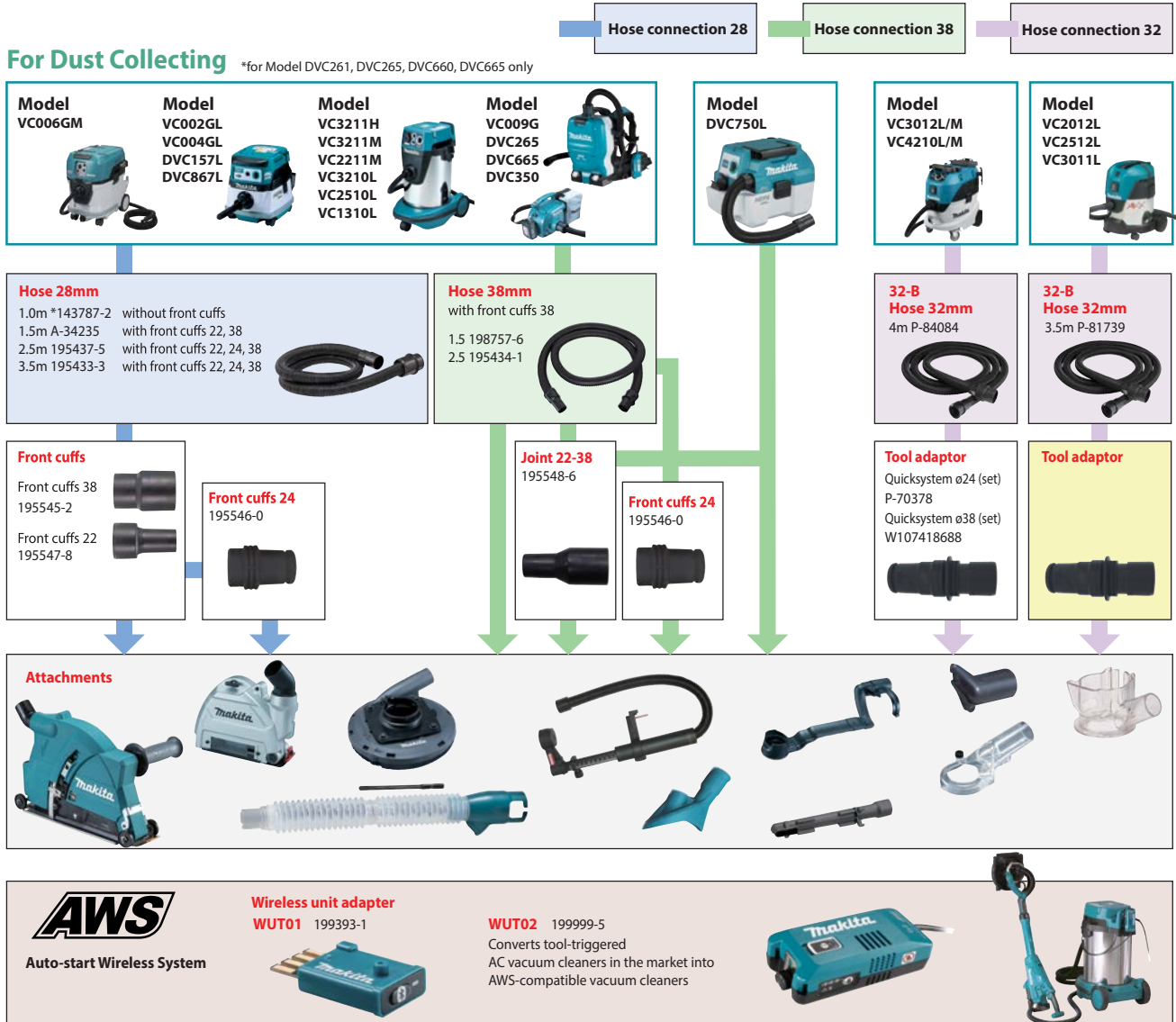

## Front cuffs, Joint & Hose Connection

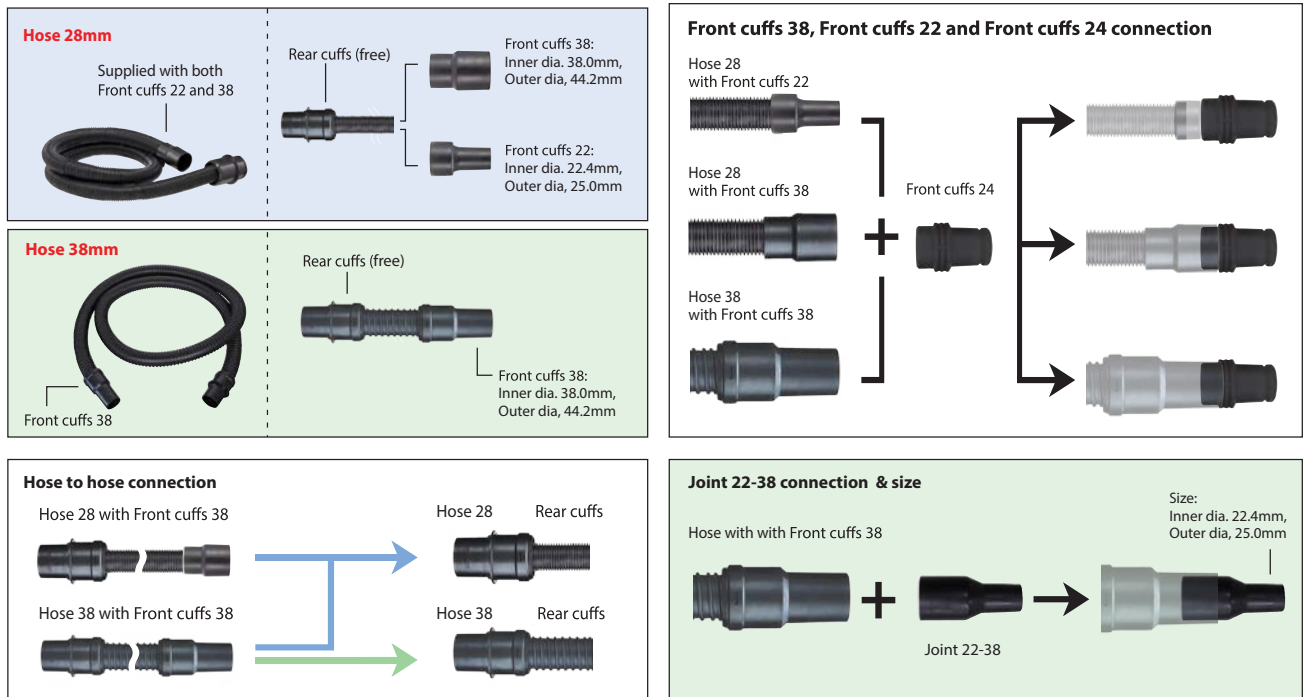

# System Charts

**A**



**W/ Ø28mm Hose**

Model  
VC002GL / VC004GL   VC3211H / VC3211M   VC008G / VC009G   DVC350  
DVC157L / DVC867L   VC2211M / VC3210L   DVC660 / DVC665  
VC2510L / VC1310L   DVC261 / DVC265

**W/ Front cuffs**



**38   24   22**

**B**



**W/ Ø38mm Hose**

Model  
VC001GL / VC003GL   VC005GL / DVC155L   DVC156L / DVC860L  
DVC861L / DVC865L   DVC866L / DVC750L

**W/ Joint 22-38**



**C**



**W/ Ø32mm Hose**

Model  
VC2012L / VC2512L   VC3011L / VC2000L

**W/ Tool adapter 24**



**Adapter 38 (option)**



P-81745   P-70421

**D**



**W/ Ø32mm Hose**

Model  
VC3012M / VC3012L   VC4010M / VC4010L

**W/ Tool adapter 24**



**38**



P-70378   W107418688

## Demolition hammer & Rotary hammer



**A B**

**Front cuffs**  
22 or 38



**C D**

**Tool adapter 24**



\*grip base for dust cup is also necessary  
\*\*With Sensormatic chip



**A B**

**Front cuffs**  
22



**C D**

**Tool adapter**  
24



Model No.	Operation mode	Vacuum Attachment Set		Cuffs Size
		Type	Part No.	
Electric breaker	---	W / Hose	191M20-4	Cuffs 24 or cuffs 38
	---	W/o Hose	197168-2	Hose 28 without cuffs
	---	W / Hose	197148-8	Cuffs 24 or cuffs 38
Rotary Hammer	Drilling Hammer	-	197148-8	Cuffs 22
	Drilling Hammer	-	196858-4	Cuffs 22
	Drilling Hammer	-	196074-8	Cuffs 22

Model No.	Operation mode	Dust Collector and Dust Cup		Cuffs Size
		Type	Part No.	
HR140D, HR166D, DHR164, DHR165, DHR171, DHR182, DHR202, DHR262, DHR263, DHR264, HR1840, HR2020, HR2022, HR2230, HR2460, HR2460F, HR2470, HR2470F, HR2470FT, HR2470T, HR2475, HR2800, HR2810, HR2810T, HR2811F, HR2811FT, *DHR164, *DHR165, *DHR171, *DHR182, *DHR202, *DHR241, *DHR262, DHR263, *HR1840, *HR1841F, *HR2230, HR2460, *HR2460F, HR2470, HR2470F, HR2475, HR2800, HR2810, HR2811F	Drilling	Dust collector set	193472-7	Cuffs 22
DHR242, DHR280, DHR282, HR001G, HR003G, HR2300, HR2600, HR2601, HR2601F, HR2630, HR2631F, HR2641, HR2651, HR2652, HR2653, HR2663, HR3001C, HR3011F, DHR243, DHR281, DHR283, HR002G, HR004G, HR2320T, HR2630T, HR2631FT, HR2653T, HR3012F	All	Dust cup set	195173-3	Cuffs 22
HR2670	All	Dust cup set	1914L7-6	Cuffs 22
HR2670	All	Dust cup set	1914L9-2	Cuffs 22

Items of standard equipment and specifications may vary by country or area.

# System Charts

## Circular saw and Plunge Cut Circular Saw

\*Inner flange is also necessary.

\*\*with shortlever

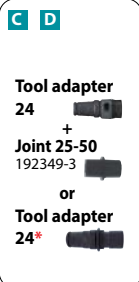

\* not needed  
Front cuffs 24



Model	Dust nozzle set and Joint set		Cuffs Size
	Type	Part No.	
DHS630	Dust nozzle set	194314-8	Cuffs 22
DHS660, DHS661	Dust nozzle set	199230-9	Cuffs 24
HS012G, DHS680	Dust nozzle set	196961-1	Cuffs 24
DHS710	Dust nozzle set	196520-1	Cuffs 24
DHS711	Dust nozzle set	196843-7	Cuffs 24
DHS780, DHS781, DHS782, DHS783	Dust nozzle set	196520-1	Cuffs 24
HS009G, HS010G, HS011G	---	---	Cuffs 24
DHS900, DHS901, DSP600, DSP601	---	---	Cuffs 24
DSS501	Dust nozzle set	194415-2	Cuffs 22
5008MG, 5008MGA	Dust nozzle set	194489-3	Cuffs 38
N5900B, 5902B	Joint set	193068-4 / 193823-4	Cuffs 38
HS003G/HS004G	Dust nozzle set	196520-1	Cuffs 24
HS301D	Dust nozzle set	452237-9	Cuffs 22
HS0600	Dust nozzle set	198263-1 / 198265-7	Cuffs 24
HS6600	Dust nozzle set	196843-7 / 196520-1	Cuffs 24
HS7010	Dust nozzle set	196520-1	Cuffs 24
HS7600	Dust nozzle set	197221-4 / 196520-1	Cuffs 24
SP6000, SP001G	---	---	Cuffs 24

## Angle grinder to diamond wheel

\*Inner flange is also necessary.

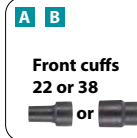
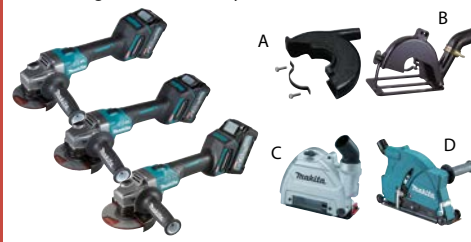

Model	Dust collection wheel guard for diamond wheel		Cuffs Size
	Type	Part No.	
100mm Single notch bearing box models	A	198413-8	Cuffs 22
	C	199295-1	Cuffs 38
9500NB N9500N	C + Rubber sleeve	192212-0 + 192202-3	Cuffs 22
125mm Triple notches bearing box models	A	198416-2	Cuffs 22
	B	192968-5	Cuffs 38
125mm Single notch bearing box models	C	196846-1	Cuffs 38
	C	191G06-2	Cuffs 38
125mm Toolless wheel cover (Slide lever style) models	C	191G06-2	Cuffs 38
180mm Triple notches bearing box without brake models	D	198514-2 (M14 spindle)	Cuffs 38
	B	194303-3	Cuffs 38
180mm Twin notches bearing box models & Single notch bearing box models	B	194303-3	Cuffs 38
230mm Triple notches bearing box without brake models	D	198440-5(EU)	Cuffs 38
	B	194044-1	Cuffs 38
230mm Twin notches bearing box models & Single notch bearing box models	B	194044-1	Cuffs 38
	D	198380-7 (M14 spindle)	Cuffs 38
230mm Single notch bearing box models	D	198380-7 (M14 spindle)	Cuffs 38
	B	194044-1	Cuffs 38

## Angle grinder to cup diamond wheel



Model	Diamond wheel Dust collection wheel guard for cup		Cuffs Size
	Wheel Size	Part No.	
125mm Toolless wheel cover (Slide lever style) models	125mm	191F81-2	Cuffs 38
125mm Triple notches bearing box models	125mm	195239-9(EU)/ 191W06-8	Cuffs 38
125mm Single notch bearing box models	125mm	195237-3	Cuffs 38
230mm Triple notches bearing box models	180mm	191X44-6	Cuffs 38

Items of standard equipment and specifications may vary by country or area.

# System Charts

For Model	Suction Systems and Part No.
<b>Belt Sander</b> DBS180 9032	<b>Dust nozzle assembly</b> 122652-8
<b>Belt Sander</b> 9031	
<b>Finishing Sander</b> DBO380, DBO381, DBO382 DBO480, DBO481 DBO482, DBO484 9046, BO3710, BO3711, BO4900/V, BO4901 BO4555, BO4556, BO4565, BO4566, BO4557, BO4558	
<b>Random Orbit Sander</b> BO5030, BO5031, BO5040, BO5041, BO6030, BO6040, DBO180	
<b>Multi Tool</b> DTM52 DTM51 TM3000C TM3010C	<b>Dust attachment set</b> 191R02-6 199627-2 199618-3 199624-8
<b>Belt Sander</b> 9404, 9902, 9903, 9910, 9911, 9920,	
<b>Random Orbit Sander</b> BO6050	<b>Front cuffs 24</b> 195546-0
<b>Nozzle complete</b> 143376-8	
<b>Cordless Drywall Sander</b> DSL800, DSL801	<b>Front cuffs 24</b> 195546-0

**A**  
Front cuffs  
22

**B**  
Front cuffs  
22-38  
195548-6

**C**  
Tool adapter  
24  
+  
Joint 25-50  
192349-3  
or  
Tool adapter  
24\*

**D**  
Tool adapter  
38  
+  
Joint 22-38  
195548-6  
or  
Tool adapter  
24\*

\* not needed  
Front cuffs 24

For Model	Suction Systems and Part No.
<b>Jig Saw</b> JV183D 4326, 4327, 4328, 4329 JV0600	
<b>Jig Saw</b> DJV180 4350T/CT/FCT, 4351T/CT/FCT	<b>Dust Nozzle</b> 417853-4
<b>Cordless Jig Saw</b> DJV181, DJV182 DJV184, DJV185 JV001G, JV002G JV102D, JV103D	<b>Dust nozzle assembly</b> 126331-0 413F05-1 122C71-6 457801-1
	<b>Front cuffs 24</b> 195546-0

**A**  
Front cuffs  
22

**B**  
Front cuffs  
22-38  
195548-6

**C**  
Tool adapter  
24  
+  
Joint 25-50  
192349-3  
or  
Tool adapter  
24\*











**D**  
Tool adapter  
38  
+  
Joint 22-38  
195548-6  
or  
Tool adapter  
24\*

\* not needed  
Front cuffs 24

















Items of standard equipment and specifications may vary by country or area.

# System Charts

For Model	Suction Systems and Part No.
<b>Angle Cutter</b> 4112H 4112HS 4114 4114S 	<b>Elbow joint 32</b> 192613-2 
<b>Dustless Cutter</b> 4100KB 	
<b>Cordless Dustless Cutter</b> DCC500 	
<b>Wall Chaser</b> SG1251, SG1250 	
<b>Concrete Planer</b> PC5000C, PC5001C PC5010C 	
<b>Belt Sander</b> 9924DB 	<b>Joint 32</b> 192518-6 
<b>Belt Sander</b> 9403, 9921 	<b>Joint 32</b> 192349-3 

- A**  
Front cuffs  
38 
- B**  

- C**  
Front cuffs  
38 
- D**  
Tool adapter  
38 

For Model	Suction Systems and Part No.
<b>Cordless Slide Compound Miter Saw</b> DLS713 DLS714 	
<b>Slide Compound Saw</b> LS0714/F/FL/L LS0815F/FL LS1016L LS1017L LS1018/L LS1216/L 	
<b>Miter Saw</b> LS1030N, LS1440 	
<b>Compound Miter Saw</b> LS1040/F, LS1045, LS1221 	
<b>Cordless Compound Miter Saw</b> DLS600 	<b>A</b> Front cuffs 38 
<b>Flip Over Saw</b> LF1000 	
<b>Table Top Miter Saw</b> LH1040/F LH1201FL 	<b>B</b>  <b>C</b> Front cuffs 38  <b>D</b> Tool adapter 38 
<b>Slide Compound Saw</b> LS1019/L, LS1219/L 	<b>Front cuffs 24</b> 195546-0 
<b>Cordless Slide Compound Miter Saw</b> LS002G, LS003G, LS004G, DLS110, DLS111, DLS112, DLS211, DLS212 	

\*Except model:  
 VC008G / VC009G  
 DVC660 / DVC665  
 DVC261 / DVC265



Items of standard equipment and specifications may vary by country or area.



# System charts

For Model	Suction Systems and Part No.
<b>Table Saw</b> 2704N	<b>Joint</b> 419093-0
<b>Table Saw</b> MLT100N	<b>Dust port</b> JM27000090
<b>Table Saw</b> 2712	
<b>Band Saw</b> LB1200F	<b>Joint</b> 419093-0
<b>Scroll saw</b> SJ401	<b>Rubber sleeve 36-38</b> A-30617
<b>Planer</b> 2012NB	<b>Hood set</b> 193036-7 Outer dia. 76 mm

**A**  
Front cuffs  
38\*

**B**

**C**  
Front cuffs  
38

**D**  
Tool adapter  
38

\*Except model:  
VC008G / VC009G  
DVC660 / DVC665  
DVC261 / DVC265  
DVC350

For inner dia. 76 mm  
Hose Vacuum Cleaner

For Model	Suction Systems and Part No.
<b>Power Planer</b> KP001G, DKP181, KP0810/C	
<b>Power Planer</b> DKP180, KP0800	<b>Nozzle</b> 451329-1
<b>Power Planer</b> 1100	<b>Chip cover</b> 415452-6
<b>Power Planer</b> 1911B	<b>Nozzle for vacuum cleaner</b> 192082-7
<b>Power Planer</b> N1900B, N1923B, KP0800, 1804N 1805N, 1806B, KP312/S	

**A**  
Front cuffs  
38\*

**B**

**C**  
Front cuffs  
38

**D**  
Tool adapter  
38

\*DVC350  
Cannot be used  
with Planer models



## Nozzle assembly



## Joint

\*Elbow



Model No.	Part No.	Model No.	Part No.
KP0800, DKP180, DKP140	451329-1	DKP180, DKP181, KP0810/C, KP0800	*191C20-4
1805N	JPA122277	1804N, 1805N, 1806B, KP312/S	181575-9

Items of standard equipment and specifications may vary by country or area.

# System Charts

For Model	Suction Systems and Part No.
<b>Plate Joiner</b> PJ7000 DPJ180 	
<b>Cut-out Tool</b> 3706 	<b>Dust collection cover</b> 193449-2 
<b>Cordless Cut-out Tool</b> DCO181, DCO180 	
<b>Cordless Drywall saw</b> DSD180, SD100D 	
<b>Router</b> RP111C, RP1110C, RP0910 	

**A** Front cuffs 22\* 









\*DVC350 Cannot be used with Router models

**B** Front cuffs 22-38  195548-6

**C** Tool adapter 24  + Joint 25-50 192349-3 

**D** Tool adapter 38  + Joint 22-38 195548-6 

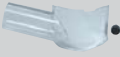
\*C: DVC350 Cannot be used with Router models

For Model	Suction Systems and Part No.
<b>Router</b> RP1802/ F, RP1803/ F, RP1801/ F, RP1800/ F, RP2302FC, RP2303FC RP2301FC, RP2300FC 	<b>Dust nozzle</b> 194934-8  192035-6 
<b>Router</b> RP0900, **RT0700C, ***RT0702C 	<b>Dust nozzle</b> 194733-8 
<b>Cordless Router</b> **RT001G, **DRT50 ***Use with Plunge base assembly 	
<b>Trimmer</b> RT0700C 	<b>Dust nozzle</b> 195559-1 
<b>Cordless Trimmer</b> RT001G, DRT50 	

**A** Front cuffs 38 

**B** 

**C** Front cuffs 38 

**D** Tool adapter 38 

Makita recommend to use 38mm hose when you use Router



Items of standard equipment and specifications may vary by country or area.

# Vacuum Cleaner System Charts

## For Cleaning

\*for Model DVC261, DVC265, DVC660, DVC665 only

with front sleeve

Hose connection 28

Hose connection 38

Hose connection 32

<b>Model</b> VC006GM DVC860L VC003GL DVC861L DVC150L DVC865L DVC151L DVC866L DVC155L DVC867L		<b>Model</b> VC3211H VC3211M VC2211M VC3210L VC2510L VC1310L		<b>Model</b> VC008G DVC261 DVC265 DVC660 DVC665 DVC350	
---	---	--	---	--	--

**Cleaning set**

- Hose complete 38-2.5
- Straight pipe
- Bending pipe
- Nozzle assembly
- Corner nozzle
- 195439-1



**Hose 38mm**  
with front sleeve (front cuffs 32A)  
1.5m 199388-4



**Hose 32mm** with front sleeve (front cuffs 32A)  
1.0m\*199453-9 1.7m 199493-7



**Hose 28mm**  
1.0m \*143787-2  
1.5m 152992-0  
2.5m 195437-5  
3.5m 195433-3



**Hose 38mm**  
1.5m 198757-6  
2.5m 195434-1



**Bent pipe** 192562-3  
**Straight pipe** 192563-1



**Bending pipe assembly with pipe lock with sleeve**  
127093-3



**Bending pipe assembly without sleeve 458184-2 (front cuffs 32A)**



**Bending pipe assembly with sleeve 126756-8**



**Front cuffs 22**  
195547-8



**38mm Tip attachments**

**Nozzle assembly**  
Flat type (Dry)  
199455-5

**F/C switching t-nozzle**  
Flooring & carpet (Dry)  
198184-7

**Universal type**  
(Dry/ Wet)  
195551-7

**Compact type A** (Dry)  
195549-4

**Compact type B**  
(Wet model only)  
195550-9

**Wide Type**  
(Wet model only)  
A-47846

**Round brush**  
191657-9

**Corner nozzle**  
410306-2



**Cyclone attachment set with pipe lock\***

- 191D71-3
- 191D73-9



**Cyclone attachment set\***

- 199491-1
- 191D75-5



**Aluminum joint pipe (L=465mm)**  
199844-4



**Aluminum straight pipe 32 (L=465mm)**  
199843-6

for others vacuum cleaner nozzles 32mm (1-1/4")

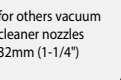

**Tapered nozzle set**  
192236-6



**Straight pipe with pipe lock**  
**Aluminum Telescopic pipe 28L**  
(L=590-942mm) 140G19-0  
Bending pipe assembly with pipe lock (140G26-3) set 191B15-1

**Plastic Telescopic pipe 28L**  
(L=590-950mm) 127605-2

**Plastic straight pipe 28L with pipe lock (L=479mm)**  
○ 459353-8  
● 458942-6

**Plastic straight pipe 28L with pipe lock (L=340mm)**  
for Cyclone attachment set  
○ 191D76-3  
● 191D77-1

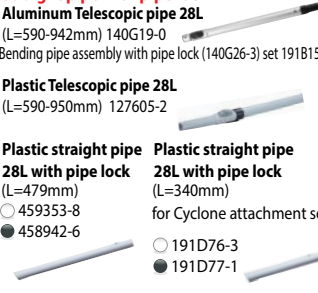

**Straight pipe**  
**Plastic Telescopic pipe 28**  
(L=500-850mm)  
123584-2

**Plastic straight pipe 28 (L=465mm)**  
○ 451424-7  
○ 451241-5  
● 451244-9  
● 456587-4

**Plastic straight pipe 28 (L=320mm) for Cyclone attachment set**  
○ 191D79-7  
● 191D80-2

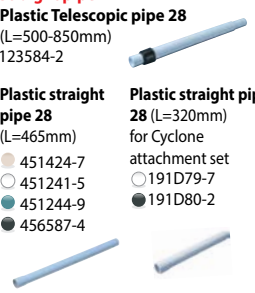

**28mm Tip attachments**

**Nozzle assembly**  
Flat type  
199454-7

**F/C switching t-nozzle 28**  
Flooring & carpet  
191G86-8

**F/C switching t-nozzle 28**  
Flooring & carpet  
○ 198183-9

**Nozzle assembly**  
Floor t-nozzle 28  
○ 123485-4  
○ 123486-2  
● 123488-8  
● 123539-7

**Floor/carpet t-nozzle**  
For rug / carpet  
○ 198525-7  
● 198526-5 / 198529-9

**Nozzle assembly**  
For rug / carpet  
122291-4

**Seat nozzle 28**  
For automobile  
○ 199038-1 ● 199039-9  
○ 199041-2 ● 198921-9  
○ 199040-4

**Seat nozzle 120 set**  
For automobile  
140H95-0

**Mat nozzle 120**  
For automobile  
459056-4

**Brush brush set**  
191M30-1

**Sash nozzle**  
○ 416041-0  
○ 451240-7  
● 451243-1  
● 456586-6

**Corner nozzle 330**  
○ 198919-6  
○ 198990-0  
● 198992-6

**Crevice nozzle 415**  
199439-3

**Round brush**  
○ 198878-4  
○ 198549-3 / 198553-2  
● 198555-8

**Shelf brush**  
○ 198873-4  
○ 198538-8  
● 198540-1

**Soft brush 360 complete set**  
140H94-2

**Rubber nozzle 330 set**  
\*422437-5

**Flexible rubber nozzle 28**  
\*197900-4

\*These nozzles cannot be attached directly to Bending pipe assembly use with telescopic pipes or straight pipes.



**Model VC2000L**



**Hose 32mm**  
2.5m  
P-81739



**Extension tubes**  
ø35x520mm black 2 pcs  
P-72942



**Floor nozzle**  
D36x260 (Dry/ Wet)  
W107402706

**Floor nozzle**  
Universal Type (Wet)  
W000014295

**Corner nozzle**  
ø35x200  
Use with P-81745  
W000029541



# Filter & Dust bag



**for Dust (Powder)**

Powder Filter Set

Damper set

Pre-filter set

Dust paper filter or Poly bag set

**for Wet & Dry**

Cloth filter or Water filter (Water only)

**Compatible with usual Poly bags or Paper filters, allowing for:**



- Quick and easy dust disposal
- Lower-running cost compared with paper dust bag



	VC006GM (Wet & Dry)	VC003GL (Wet & Dry)	VC004GL (Dry)	DVC155L, DVC865L, DVC860L (Wet & Dry)	VC3210L, VC2510L (Wet & Dry)	VC1310L (Wet & Dry)
<b>Use as a set</b>						
<b>Powder filter set</b> Dry only	1911B6-0 	*191V70-3 	*191V70-3 	*197166-6 	195441-4 *191F82-0 	195438-3 
*HEPA filter for Dry use only	*1911B7-8 					
<b>Damper set</b>	1911B4-4 	191V68-0 	191V68-0 	195552-5 	195552-5 	195552-5 
<b>Pre-filter set</b>	1911B5-2 	191V69-8 	191V69-8 	195553-3 	195612-3 	195553-3 
<b>Cloth filter</b> Wet & Dry		144625-1 	144625-1 	140248-3 		
<b>Water filter</b> Wet only It is recommended using water filter when picking up large amount of water repeatedly.	1910N0-0 	191V67-2 		195555-9  DVC155L, DVC865L, DVC860L only	VC3210L: 195611-5 VC2510L: 195556-7 	195555-9 
<b>Dust paper filter 7L (5pcs)</b> for dry powder				A-49541 		A-49541 
<b>Filter bag set</b> 10L/15L/25L/35L (5pcs) for dry dust	35L: 1910Y4-9 	10L: 1912R3-4 VC001GL, VC002GL, VC005GL, DVC860L, DVC861, DVC865L, DVC866L, DVC867L 15L: 195557-5 VC003GL, VC004GL, DVC155L, DVC156L, DVC157L 			25L: 195558-3 VC3210L only 15L: 195557-5 VC2510L only 	15L: 195557-5 
<b>Poly bag set (10pcs)</b>	1910R3-2 	195432-5 	195432-5 	195432-5 	195440-6 	195432-5 

To use powder filter, remove the float cage and float by removing the bolts.

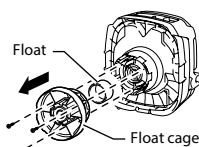

**Capacity up tank set**

DVC860L, DVC861L, DVC865L, DVC866L, DVC867L

\* "HEPA filter" Mark on tank

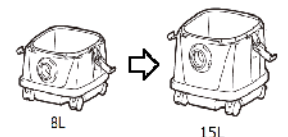

# Cordless Cleaner System Charts

Color

**With pipe lock Model:**

- CL001G
- CL002G
- CL003G
- DCL283F
- DCL284F
- DCL286F
- CL117FD



**Model:**

- DCL180
- DCL181F
- DCL182
- CL183D
- CL106D
- CL107FD
- CL108FD
- CL100D



**Model:**

- CL070D
- CL072D



**Model:**

- DCL184, CL121D



**Cyclone attachment set with pipe lock**

- 191D71-3
- 191D73-9



**Dust capsule conv. kit Cyclone unit set**

- 1910D3-4
- 1910D5-0



**Flexible hose set**

191E30-3



**Cyclone attachment set**

- 199491-1
- 191D75-5



\*Included sensomatic

**Flexible hose set**

- 191496-7
- 198867-9
- 198541-9
- 198542-7
- 198870-0
- 198543-5



**Straight pipe with pipe lock**

**Aluminum Telescopic pipe 28L**  
(L=590-942mm) 140G19-0  
Bending pipe assembly with pipe lock (140G26-3) set 191B15-1

**Plastic Telescopic pipe 28L**  
(L=590-950mm) Gray 127605-2  
(L=479-719mm) ○ 1910Y3-1

Compatible model: CL001G, CL002G, CL003G, DCL283F, DCL284F, DCL286F

**Plastic straight pipe 28L with pipe lock**  
(L=479mm)  
○ 459353-8  
● 458942-6

**Plastic straight pipe 28L with pipe lock**  
(L=340mm)  
○ 191D76-3  
● 191D77-1



**Straight pipe Plastic Telescopic pipe 28**  
(L=500-850mm)  
○ 123584-2

**Plastic straight pipe 28 (L=465mm)**  
○ 451424-7  
○ 451241-5  
● 451244-9  
● 451425-5  
● 456587-4

**Plastic straight pipe 28 (L=320mm)**  
for Cyclone attachment set  
○ 191D79-7  
● 191D80-2

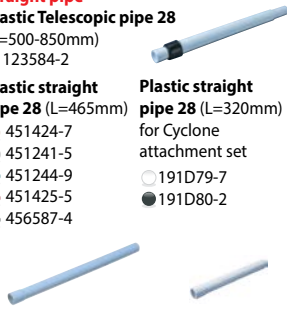

**Blower nozzle complete**

140J64-3



**Flexible rubber nozzle 28**

197900-4



## 28mm Tip attachments

**Nozzle assembly**

Floor t-nozzle 28

- 127825-8
- 127827-4
- 127828-2



**Seat nozzle 28**

For automobile

- 199038-1
- 199041-2
- 199040-4
- 199039-9
- 198921-9



**Round brush**

- 198878-4
- 198553-2
- 198554-0
- 198881-5
- 198555-8

Gray 191D67-4



**Rubber nozzle 330 set**

\*422437-5

\*These nozzles cannot be attached directly to Bending pipe assembly use with telescopic pipes or straight pipes.



**Nozzle assembly**

Floor/carpet t-nozzle 28

- 191X06-4



**Seat nozzle 120 set**

For automobile

140H95-0



**Shelf brush**

- 198873-4
- 198538-8
- 198539-6
- 198876-8
- 198540-1



**Holder set** Part No. 199971-7

Model: CL001G, CL002G, DCL283F, DCL284F, DCL285F, DCL180, DCL180F, DCL181F, DCL182, DCL182F, CL114FD, CL107FD, CL072D



**F/C switching t-nozzle 28**

Flooring & carpet

191G86-8



**Mat nozzle 120**

For automobile

459056-4



**Soft brush 360 complete set**

140H94-2



**F/C switching t-nozzle 28**

Flooring & carpet

- 198183-9



**Brush nozzle set**

191M30-1



**Sash nozzle holder 28**

For Plastic straight pipe

Model: CL001G, CL002G, CL003G, DCL283F, DCL284F, DCL285F, DCL286F, CL114FD, CL117FD

- 459354-6



**Nozzle assembly**

Floor t-nozzle 28

- 123485-4
- 123486-2
- 123488-8
- 123489-6
- 123843-4
- 123539-7



**Sash nozzle**

- 416041-0
- 451240-7
- 451243-1
- 416225-0
- 457228-5
- 456586-6



**Floor/carpet t-nozzle**

For rug / carpet

- 198525-7
- 198882-3
- 198526-5



**Corner nozzle 330**

- 198919-6
- 198990-0
- 191D65-8



**Others Model**

- 416043-6
- 451242-3
- 456585-8

Plastic straight pipe

Sash nozzle holder 28

Sash nozzle

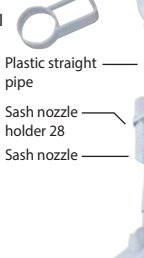

**Cleaner stand set** Part No. 1911L1-0

For holding Makita cordless cleaner in an upright position.

Model: CL001G, CL002G, CL003G, CL070D, CL100D, CL102D, CL106FD, CL107FD, CL108FD, CL111D, CL114FD, CL117FD, CL183D, DCL180, DCL181F, DCL182, DCL283F, DCL284F, DCL285F, DCL286F



## Capsule type cleaner Model: CL001G, DCL283F, DCL284F, DCL181F, DCL180F, DCL180, CL183D, CL108FD, CL106FD, CL070D

**HEPA filter**  
199989-8  
**HEPA filter**  
Except Model: CL183D

**HEPA filter + Pre filter**

**HEPA filter + Easy shake off dust filter**

**Filter + Pre filter**

**Pre filter**  
451208-3

**Stay (Filter flame)**  
458467-0

**Filter**  
443060-3

**Easy shake off dust filter**

**Easy shake off dust filter (High performance filter)**  
199966-0  
455176-2

**Valve**  
424208-6

**Sponge sheet 57**  
422268-2  
Except Model: CL070D, CL183D

## Paper bag type cleaner Model: CL002G, DCL182, DCL182F, CL114FD, CL121D, CL107FD, CL072D, DCL184, CL121D

**Cordless Cleaner**

**Sponge sheet 76-110 (Recessed wall)**  
424804-0

**Guard**  
413177-0  
CL002G only

**Paper filter Anti-bacterial type (High performance filter)**  
10per pkg. 198744-5 (EU)  
5per pkg. 198745-3

**Valve stay complete (Dust stopper)**  
143677-9  
DCL184, DCL182, DCL182F, CL114FD, CL121D, CL107FD, CL072D  
140K23-3  
CL002G

**Dust bag**  
198746-1  
166084-9 (w/o pkg)

**Easy shake off dust bag**  
198749-5  
Except Model: CL002G only

**High performance dust bag set**  
1910M4-5  
CL002G only

**DCL184, CL121D**

**Sponge sheet 90**  
422440-6

## New cyclone unit Model: CL001G, CL003G, DCL283F, DCL284F, DCL286F, DCL180, DCL181F

Compatible model:  
CL001G, DCL283F, DCL284F, DCL180, DCL181F

CL003G, DCL286F (Standard Equipment)

**Cyclone unit**

**Sponge sheet 62**  
422909-0 (Standard Equipment)

**HEPA filter**  
1910C9-5

**High performance filter set**  
1910C7-9 (Standard Equipment)

**Sponge filter**  
422908-2 (Standard Equipment)

Part No. 1910D3-4

Part No. 1910D5-0

## Cleaner carrying bag

Cleaner body, battery, charger and accessories can be stored together.



Except Model: CL003G, DCL286F, DCL184, CL121D (LxWxH: 600x210x190mm)  
Part No. 199901-8



Model: DCL184, CL121D (LxWxH: 490x210x230mm)  
Part No. 199900-0

## Blue dust capsule

Transparent blue dust capsule. You can see the accumulated dust.

Model: DCL280F, DCL281F  
Part No. 136106-9



## Cordless Upright Cleaner Model: DVC560

Color

### 28mm Tip attachments

#### Seat nozzle 28

For automobile

- 199038-1
- 199041-2
- 199040-4
- 199039-9
- 198921-9



#### Long sash nozzle 330

- 191D65-8
- 198919-6
- 198990-0
- 198992-6



#### Seat nozzle 120 set

For automobile  
140H95-0



#### Crevice nozzle 415

199439-3



#### Mat nozzle 120

For automobile  
459056-4



#### Round brush

- 191D67-4
- 198878-4
- 198553-2
- 198555-8



#### Brush nozzle set

191M30-1



#### Shelf brush

- 198873-4
- 198538-8
- 198540-1



#### Sash nozzle

- 416041-0
- 451240-7
- 456586-6



#### Soft brush 360 complete set

140H94-2



#### Filter bag set

10pcs. set  
191T96-3



#### Dust bag set

191Y86-6



#### Main filter h set

191E39-5



#### Brush complete set

1910T8-6

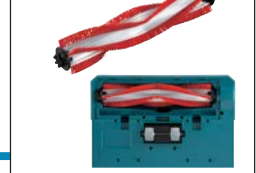

## Cordless Portable Vacuum Cleaner Model: DVC750L

### For Cleaning Hose Complete

28-2.0m with  
Front cuffs 38  
140G04-3



### 38mm Tip attachments

#### Wide Nozzle

458891-7



#### Sash Nozzle

458919-1



#### Round brush

191657-9



#### Corner nozzle

410306-2



#### Joint 22-38

195548-6



#### Tapered nozzle set

192236-6



#### Joint 38

418500-0



### 28mm Tip attachments

### Dry only

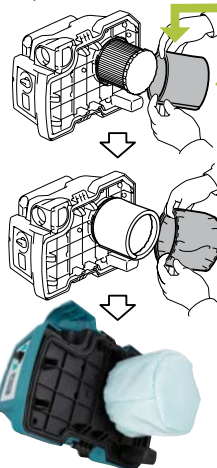

#### Filter complete (HEPA filter)

Dry  
162518-0



#### Pre filter and Damper set

Dry only 199827-4

#### Damper

422449-8



#### Pre filter

162635-6



### Wet only



#### Wet filter set

191M39-3



#### Shoulder Belt Set

162523-7



## Backpack Vacuum Cleaner Model: VC008G, VC009G, DVC660, DVC665, DVC261, DVC265

### VC011G, VC012G, DVC660, DVC665



- Dust bag assembly**  
191C30-1
- Filter bag set** (Paper dust bag)  
10per pkg.  
191C26-2
- Main filter H set**  
(HEPA filter)  
191D12-9

### VC008G, VC009G, DVC261, DVC265



- Dust bag assembly**  
197898-5
- Filter bag set** (Paper dust bag)  
10per pkg.  
197902-0  
197903-8
- Filter set assembly**  
(HEPA filter)  
191Y27-2 (VC008G, VC009G)  
127725-2 (DVC261, DVC265)

### Harness cover set

Washable harness cover made of a mesh material for improved breathability

### VC008G, VC009G, VC011G, VC012G, DVC261, DVC265

191Y14-1



### Protection cover set

When using Backpack vacuum cleaner in tight spaces etc., Protection cover is very helpful to prevent the scratches on surrounding objects caused by hitting cleaner.

### DVC261, DVC265

1910S4-7

### VC008G, VC009G

1911W4-1



## Robotic Cleaner Model: DRC200, DRC300

### DRC200

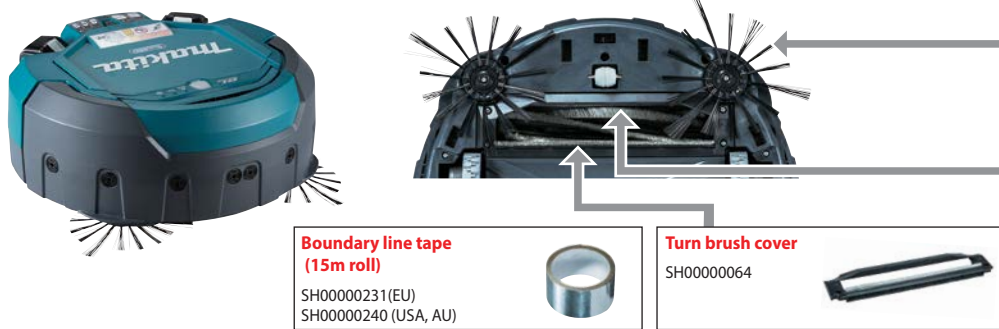

- Side brushes**  
SH00000321 (Soft)  
SH00000065 (Standard)
- Power brush**  
SH00000320 (Soft)  
SH00000063 (Standard)  
SH00000319 (Combination)
- Boundary line tape**  
(15m roll)  
SH00000231 (EU)  
SH00000240 (USA, AU)
- Turn brush cover**  
SH00000064
- Filter**  
SH00000213

### DRC300

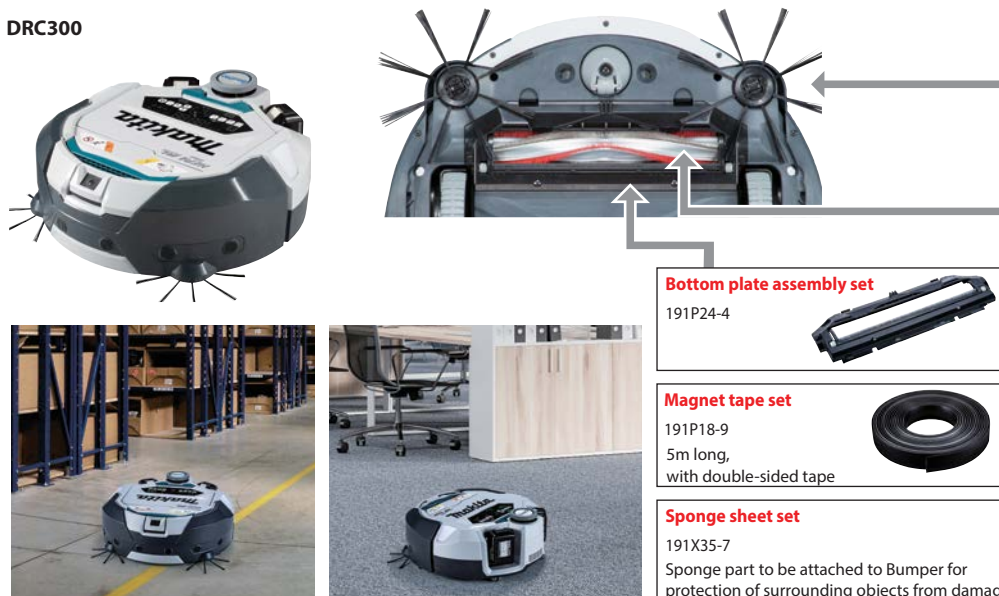

- Side brush assembly set**  
191P26-0 (Soft) for tatami mats, etc.  
191P28-6 (Standard)
- Main brush complete set**  
191P20-2 (Soft) for tatami mats, etc.  
191P22-8 (Standard)
- Bottom plate assembly set**  
191P24-4
- Magnet tape set**  
191P18-9  
5m long,  
with double-sided tape
- Filter H complete set**  
191P31-7
- Sponge sheet set**  
191X35-7  
Sponge part to be attached to Bumper for  
protection of surrounding objects from damage



# Dust Extraction

## 28mm Hose



Length (m)	Hose type	Front cuffs	Included Items	Part No.
1.0	Antistatic hose	without cuffs	---	143787-2
1.5	Antistatic hose	Front cuffs 38	---	152992-0
1.5	Antistatic hose	Front cuffs 38	Front cuffs 22	A-34235
2.5	Antistatic hose	Front cuffs 22	Front cuffs 38 Front cuffs 24	195437-5
3.5	Antistatic hose	Front cuffs 38	Front cuffs 22 Front cuffs 24	195433-3

## Front Cuffs for 28mm hose or joint

Type	Hose Side	Cuff Type	Part No.
Front cuffs 22	28mm hose w/o cuffs	cuffs 22	195547-8
Front cuffs 38	28mm hose w/o cuffs	cuffs 38	195545-2
Front cuffs 24	Cuffs 22 or Cuffs 38	cuffs 24	195546-0
Joint 25 set	Cuffs 24	cuffs 22	192349-3
Rubber sleeve 18-21	Cuffs 22	For 18-21mm pipe	192202-3

## Hose band



Hose Size	Part No.
28/32/38	166116-2

## 28mm Bending pipe



Matching hose set / Matching cuffs	Matching pipe	Part No.
28mm hose w/o cuffs	28L	127093-3
	28	126756-8

## Straight pipe 28L & 28

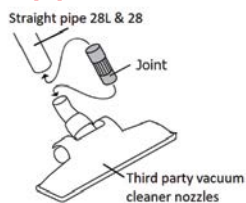

Joint type	Part No.	Third party vacuum cleaner nozzles
C38	191M79-1	Proteam Side Winder
B35	191M78-3	KARCHER Nilfisk
A32	191M77-5	PACVAC SHOPVAC Proteam

## Aluminum pipe 32

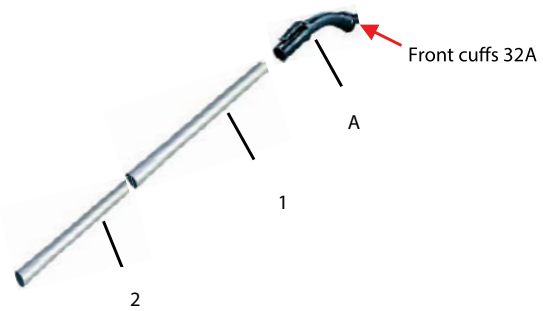

Item	Description	Material	Part No.
1	Aluminum joint pipe 32 (L=465mm)	Aluminum	199844-4
2	Aluminum straight pipe 32 (L=465mm)	Aluminum	199843-6

## Hose 38mm



Length (m)	Hose type	Front cuffs	Part No.
1.5	Antistatic hose	Front cuffs 38	198757-6
2.5	Antistatic hose	Front cuffs 38	195434-1

## Joint 38mm hose

Type	Hose Side	Nozzle side	Part No.
Front cuffs 24	Cuffs 22 or Cuffs 38	Cuffs 24	195546-0
Joint 22-38	Cuffs 38	Cuffs 22	195548-6
Joint 38	Cuffs 38	Nozzle 28	418500-0
Joint 25 set	Cuffs 38	70mm pipe with O-ring	181575-9

## Nozzle assembly for vacuum & blow



Model	Size (mm)	Part No.
DUB182, DVC350	220	132025-7
UB100D, UB101D, DUB185, DUB186 UB1102, UB1103	220	123245-4
	430	123246-2

# Dust Extraction

## Cleaning set

Includes one each of:  
 -Hose complete 38-2.5  
 -Straight pipe  
 -Bending pipe  
 -Nozzle assembly  
 -Corner nozzle



Part No.
195439-1

## Aluminum pipe 38

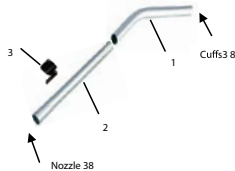

Item	Description	Material	Part No.
1	Bending pipe	Aluminum	192562-3
2	Straight pipe	Aluminum	192563-1
3	Stopper + Screw M4 x 20	---	451350-0 413R35-4

## Aluminum Telescopic pipe 38



Length (mm)	Part No.
606-958	1912G4-5

## 32mm Hose B type



Model No.	Size	Length (m)	Part No.
VC2012L, VC2512L, VC3011L	32B	3.5	P-81739

## Tool adaptor



Model No.	Description	Part No.
VC3012L/M, VC4210L/M VC2012L, VC2512L, VC3011L	Joint 25-50	192349-3

## Filter & bag

Model No.	Description	Per pkg.	Part No.
VC2000L	Fleece filter bag (Filter bag)	5	P-72899
	Pre Disposal bag	5	P-70297
	PET Filtecent	1	P-70219

## Dust bag



Model	Part No.
DUB182, UB1100, UB1101	122321-1
DUB185, DUB186, UB100D, UB101D, UB1102, UB1103	123241-2

## Flexible hose set



Model	Part No.
DUB185, DUB186, UB100D, UB101D, UB1102, UB1103	191M34-3

## Wiper nozzle set (for blowing away)



Model	Part No.
DUB185, DUB186, UB100D, UB101D, UB1102, UB1103	191M32-7

## Brush nozzle set



Model	Part No.
DUB185, DUB186, UB100D, UB101D, UB1102, UB1103	191M30-1













## For DCL501

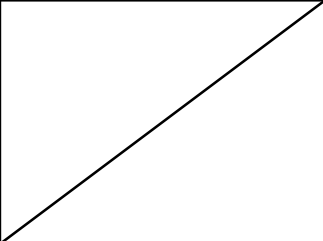

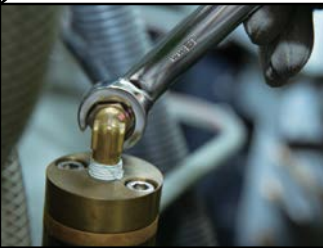
Model	Type	Part No.
Hose	-	SH00000034
Straight pipe	Adjustable length	SH00000060
Nozzle assembly	Flooring & carpet	SH00000058
Crevice nozzle	-	SH00000042



# Miscellaneous

<p><b>Adjustable wrench</b></p> 			<p>Wide excursion jaw allows each tool to work with even more fastener sizes.</p>	
<p><b>Spanner</b></p>	<p><b>Open end</b></p> 		<p>U-shaped opening grips with two opposite face of the bolts and nuts. Due to the opening, it can easily access to bolts and nut.</p>	
	<p><b>Flare end</b></p> 			<p>Narrow opening which is wide enough to fit over the tube. Large contact surface with fastener reduces rounding. Suitable for aluminum, copper and brass hexagonal fittings on oil pipe.</p>
	<p><b>Box end</b></p> 			<p>Enclosed opening grips snugly fits the faces of the bolts and nuts. Force can be applied to bolts or nuts with decreased chance of damaging.</p>
<p><b>Ratcheting wrench</b></p> 			<p>The ratcheting mechanism allows fastener to be tightened or loosened without disconnecting the tool from it. It makes the works more rapidly.</p>	
<p><b>Hex key wrench with ball-end</b></p> 			<p>Used for tightening or loosening cap screw and bolts with hexagonal sockets attached to their heads. A ball end allows the tool to be used at an angle off-axis to screw and bolt. It means it can used at tightening area.</p>	



# Miscellaneous

## Tape measure



Makita tape measure is highly durable and convenient. When the scales are blurred or hook is lost, that would be the end of it's life. This measure is for professional which has a special coated tape, hook protector and damper which absorbs shocks leads to great durability.



### Feature

#### 1. Special Coating

- \* "DURA COAT" makes 5 times more durable
- \* "SILICA COAT" makes easier note



#### 2. High durability of Hook

- \* Installed damper absorbs the shock on the hook
- \* Hook protector reduces the shock on the hook
- \* Tightly fixed hook with "4rivets+protector"



#### 3. Convenience

- \* 2-sided print
- \* Hook with magnet
- \* "Matte finish" makes easier to read scales
- \* Standout

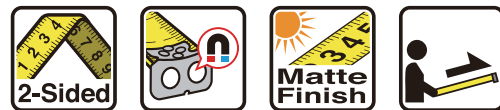

### Printed size



Size	Length	Width	Part No.
cm/inch	2m/6ft	13mm / 1/2"	E-10590

Size	Length	Width	Part No.
cm	3.5m	16mm	B-57130

### Tape measure with holder & safety cord

Size	Length	Width	Part No.
cm/inch	7.5m/25ft	25mm/1"	B-68351

# Miscellaneous

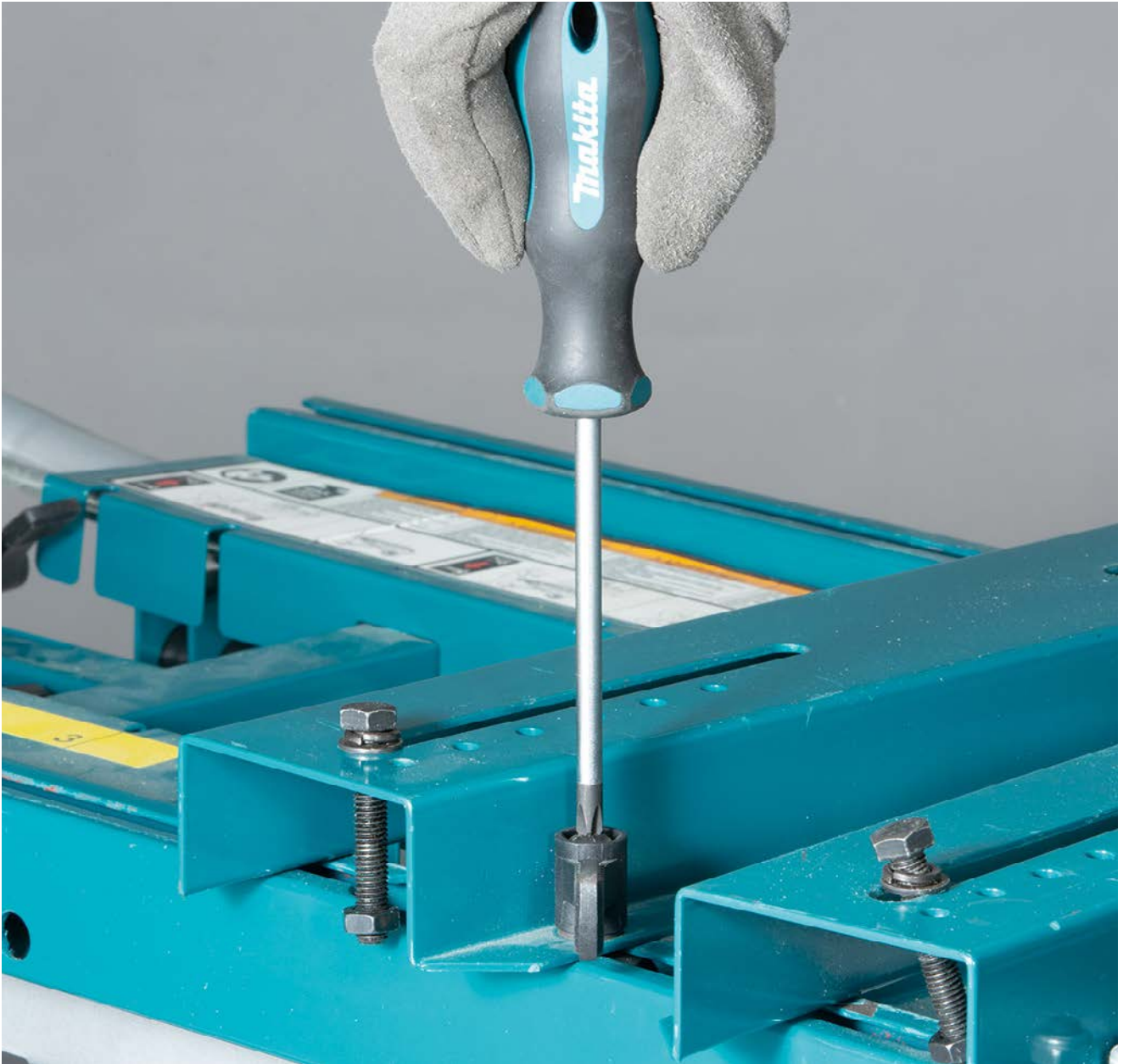

## Screw driver



	Size	Length (mm)	Part No.
+	PH2	100	B-65919

# Miscellaneous

## Pass thru socket set



Contents	Sum	Part No.
Pass thru Socket: 10, 11, 12, 13, 14, 15, 16, 17, 18, 19mm, Pass thru Socket: 3/8", 7/16", 1/2", 9/16", 5/8", 11/16", 3/4", Socket adapter: 1/4", 3/8", Pass thru Extension bar: 75mm, Ratchet handle (Pass thru handle straight)	21	B-65604

## Pass thru extension bar



Part No.
B-65632

## Socket adapter



Sum	Part No.
1/4"	B-65844
3/8"	B-65850

## Locking flex pass thru handle



Part No.
B-65626

## Pass thru handle straight



Part No.
B-65610

## Pass thru socket



Size	Part No.
13mm	B-65676

## Retractable utility knife



Part No.
B-65785

## Quick change Folding utility knife



Part No.
B-65501

# Miscellaneous

## Combination wrench 9pcs. set



Size	Part No.
8, 10, 12, 13, 14, 15, 16, 17, 18mm	B-65539

## Double ratchet wrench 8pcs. set



Size	Part No.
8, 10, 12, 13, 14, 15, 17, 19mm	B-65523

## Double box wrench 5pcs. set



Size	Part No.
8x9, 10x11, 12x13, 14x15, 18x19mm	B-65551

## Adjustable wrench



Length	Capacity	Part No.
8"(200mm)	36mm	B-65420
10"(250mm)	38mm	B-65436
12"(300mm)	43mm	B-65442

## Flare nut wrench 5pcs. set



Size	Part No.
9x11, 10x12, 13x14, 15x17, 16x18mm	B-65545

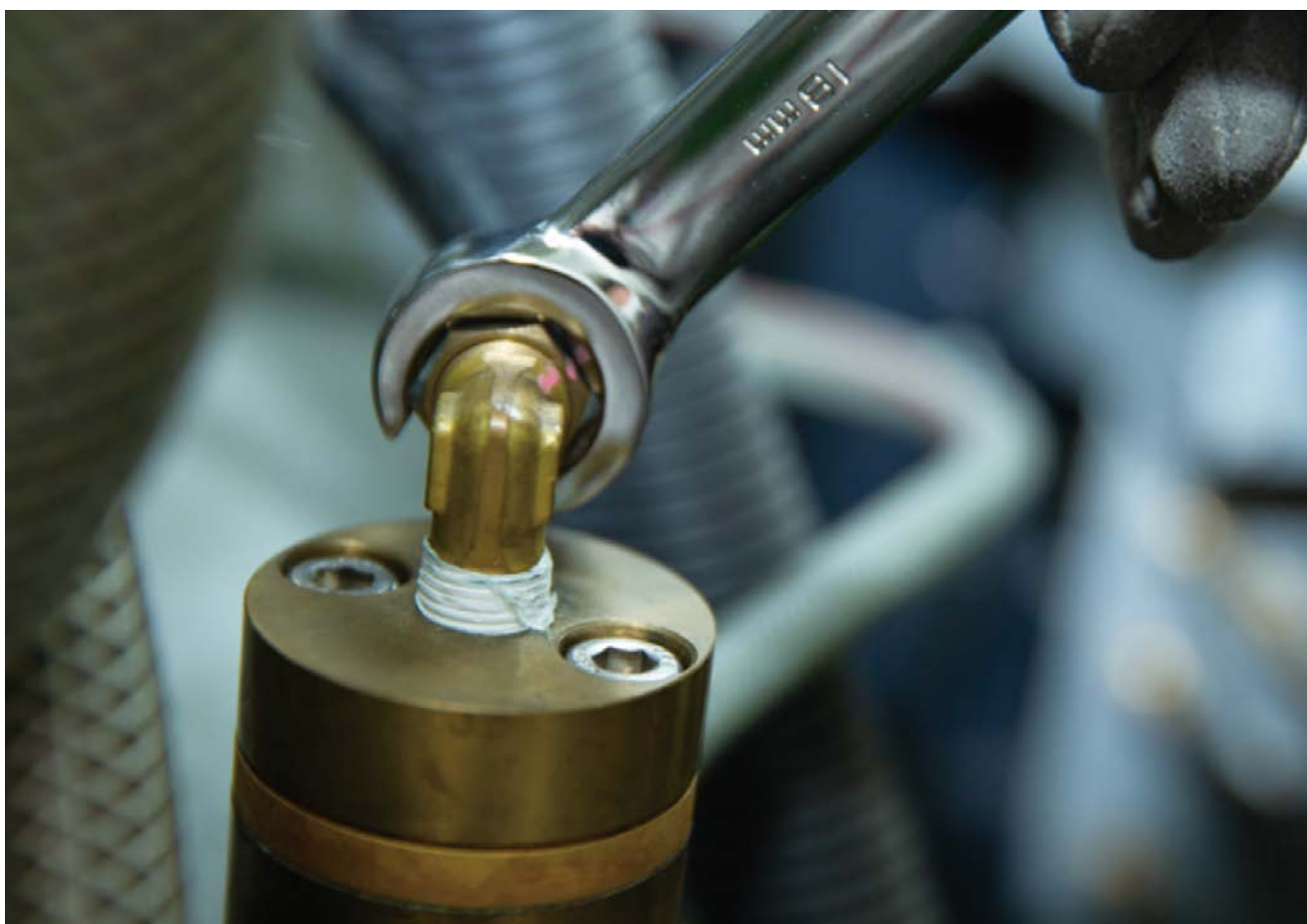



# Miscellaneous

## MAKPAC Stacking Cases



Description	Part No.
Makpac case 4 drawer (L : 395mm X W : 295mm X H : 210mm)	P-84311



Description	Part No.
Makpac case 5 drawer (L : 395mm X W : 295mm X H : 320mm)	P-84349



Description	Part No.
Makpac case 12 drawer (L : 395mm X W : 295mm X H : 210mm)	P-84327



Description	Part No.
Makpac stackable cantilever tool box (L : 395mm X W : 295mm X H : 234mm)	P-84137



Description	Part No.
Makpac organiser set (L : 395mm X W : 295mm X H : 105mm)	191X80-2

## Joint Plastic Case



Type	Size(mm)	Part No.
Small	105 x 395 x 295	821549-5
Medium	158 x 395 x 295	821550-0
Large	210 x 395 x 295	821551-8
Extra Large	316 x 395 x 295	821552-6



## Trolley



*Image is for reference only*

Part No.
TR0000002

## Tray



Part No.
P-83652

# Miscellaneous

## Pin nail



Model No.	Type	Length	Part No.
AF201Z, AF353, DPT351, DPT353, PT354D, AF353, DPT351, DPT353, PT354D	23Ga(φ0.6) Pin Nail (3,000 pcs/box)	18mm (11/16")	F-00013
		25mm (1")	F-31838
		30mm (1-3/16")	F-01819
		35mm (1-3/8")	F-00055

## Brad Nail



Model No.	Type	Length	Part No.
AF506, DBN350, DBN500	18Ga Brad Nail (5,000 pcs/box)	15mm (5/8")	B-04307

## Staple



Model No.	Type	Length	Part No.
DST421	4mm Crown Staple 16 ga (5,000 pcs/box)	10mm	B-04400
		13mm	B-04416
		19mm	B-04438
		22mm	B-04444
		25mm	B-04450
DST121	10mm Crown Staple 16 ga (5,000 pcs/box)	22mm	B-04503

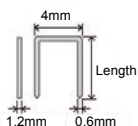

## Hex wrench





Model No.	Size	Part No.
JN1601, 2012NB	2.5mm	783208-8
JN3200, JS1600, JS1660, JS1670, 4331D, 4333D, 4334D, 4300BA, 4300BV, 4326/M, 4327/M, 4328, 4329, JV0600	3mm	783201-2
JS3200, 4350T/CT/FCT, 4351T/CT/FCT, BJV140, BJV180, 1806B, N1923B, 1911B	4mm	783202-0

## Side Grip / Front cover

Model No.	Item	Part No.
UT1305, UT2204		152892-4





## Shaft Holder

Model No.	Item	Description	Part No.
DUT130 DUT131		1+2 Chuck 13mm + Chuck key set Capacity: 1.5-13mm Thread size: 1/2-20 UNF	196008-1
		1 Chuck 13mm Capacity: 1.5-13mm Thread size: 1/2-20 UNF	766016-2
		2 Chuck key S13	763448-4
UT1305		Shaft holder 1/2-M12	323962-8
UT2204		Shaft holder 5/8-M12	324265-3

# Miscellaneous

## Mixing blade



Application	Mixing Blade			Bolt		Shaft			Model
	Size	Material	Part No.	Bolt Size	Part No.	Bolt Size of Power Mixer	Size	Part No.	
	130mm	INOX	A-43670	M8 x 18	265220-5	M12	L=584mm D=12mm	321086-4	UT1301
	135mm	Aluminum	A-43723	W5/16 x 16	265475-2	M12	L=584mm D=12mm	-	DUT130 UT1305 UT2204 UT001G
	150mm	INOX	*A-43686	---	---	M12	L=584mm D=12mm	168349-5	DUT130 UT1305 UT2204 UT001G
	165mm	INOX	A-43692	M8 x 18	265220-5	M12	L=584mm D=12mm	168349-5	DUT130 UT1305 UT001G
	175mm	Aluminum	136865-5	W5/16 x 16	265475-2	M12	L=584mm D=12mm	-	UT1305 UT2204 UT001G
	183mm	Aluminum	A-43739	W5/16 x 16	265475-2	M12	L=584mm D=12mm	-	UT1305 UT2204 UT001G
	190mm	Steel	A-33065	W5/16 x 16	265475-2	M12	L=584mm D=12mm	-	UT2204 UT001G
	201mm	Steel	A-33071	W5/16 x 16	265475-2	M12	L=584mm D=12mm	-	UT2204 UT001G
	220mm	Aluminum	A-43717	M8 x 16	265440-1	M12	L=584mm D=12mm	-	UT2204 UT001G
	175mm	Aluminum	312D12-8	M8 x 16	265440-1	M12	L=584mm D=12mm	-	UT001G

# Accessories for Tools

\*Compatible with our DC tools only  
 \*\*Compatible with both our DC and AC tools

190

Screwing/  
Drilling

Drill chuck assembly for impact driver



Angle attachment



Straight head

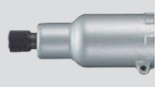

Autofeed attachment



Locator



Drill chuck



200

Hammer drilling/  
chiselling

Drill chuck assembly



Dust cup



Dust extraction system set



Grease vessel



Hammer service kit



206

Grinding/  
sanding/  
polishing

Inner flange & Lock nut

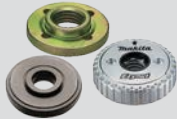

Wheel guard



Rubber pad



Lock nut wrench



Collet corn/  
Collet nut



Punch plate



212

Cutting

Dust cover



Tilt base



Rip fence



Cover set



Cutting wax



Punch/ Die



216

Sawing

Vise assembly



Guide rule



Stand



Guide rail

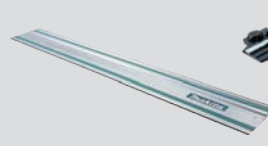

Guide Rail Adaptor

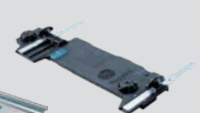

221

Milling/  
planing

Chamfering rule/  
Guide rule



Collet corn/  
Collet nut



Straight guide assembly



Trimmer base



Templet guide



223

Others

Robotic mower accessories



Grease Gun accessories



Heat Gun accessories



Rechargeable Green Multi Line Laser accessories



Hook



Carbon brush



# Cordless Tools

## Straight head, Angle head, Angle wrench head, Ratchet head

Angle head



Angle wrench head



Ratchet  
For Model:

DTL060, DTL061, DTL062, DTL063, TL064D, TL065D

Description	Type	Part No.
Angle head	-	135183-8
Ratchet head	Hex. Size 21mm	192439-2

## Ratchet head adapter (Socket, Socket adapter)

Use with Ratchet head  
Socket



Model No.	Type	Size	Part No.
DTL060, DTL061, DTL062, DTL063, TL064D, TL065D	Hex Socket	17 x 31 (A x L)	134743-3
		19 x 33 (A x L)	134744-1

## Socket adapter

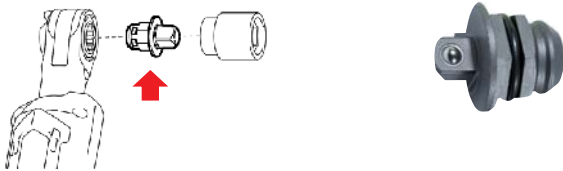

Model No.	Type	Size	Part No.
DTL060, DTL061, DTL062, DTL063, TL064D, TL065D	Socket adapter	9.5mm (3/8")	134745-9
		12.7mm (1/2")	134746-7
DWR180, WR100D	Socket adapter	6.35mm (1/4")	191A51-1
		9.5mm (3/8")	191A50-3

## Threaded Rod Cutter Blade set (2pcs set)



For Model:  
DSC102 SC103D

Thread type	Thread size	Part No.
ISO Metric	M6	199086-0
	M8	199084-4
	M10	199083-6
ISO Inch / BSW (British Standard Whitworth)	3/8"-16 UNC / W3/8	199081-0

## Shoulder strap



Model No.	Part No.
DSC102 SC103D	199069-0

## Cutter Blade set (2pcs set) for steel rod cutter

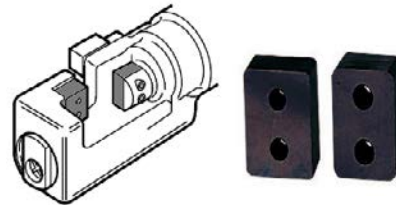

Model No.	Part No.
DSC162, DSC162R, DSC163	SC09002470
DSC191, DSC191R	SC09002030

## Holder set

A: 300ml size Holder



B: 600ml size Holder



C: 800ml size Holder



D: 400mL size Holder



Model No.	Type	Size	Part No.
CG100D, DCG140, DCG180	A	300ml	196351-8
	B	600ml	1911T4-0
	C	800ml	197195-9

# Cordless Tools

For DPP200

## Combination of punch and die

- Punching holes through a thin structural metal plate may cause deformation of the plate and burr on the holes.
- If you need precision punching, see the tables below to select an optimum combination of punch and die.

● Round punching    ○ Oblong punching



● Round punching						
Punch		Die		Cutting material		
				Tensile Mild Steel (65,000 psi)	Channel	Tensile Stainless Steel (89,000 psi)
Hole diameter (mm)	Part No.	Hole diameter (mm)	Part No.	Thickness		
6	SC05340040	SB6	SC00000203	t2-t4		t3-t4
6.5	SC05340050	SB6.5	SC00000205	t2-t6		t3-t4
8	SC05340060	SB8	SC00000207	t2-t6		t3-t4
8.5	SC05340070	SB8.5	SC00000209	t2-t6		t3-t4
10	SC05340080	SB10	SC00000211	t2-t6	t7.5	t3-t4
11	SC05340090	SB11	SC00000213	t2-t8	t7.5	t3-t6
12	SC05340100	SB12	SC00000215	t2-t8	t7.5	t3-t6
13	SC05340110	SB13	SC00000217	t2-t8	t7.5	t3-t6
14	SC05340120	SB14	SC00000219	t2-t8	t7.5	t3-t6
15	SC05340130	SB15	SC00000221	t2-t8	t7.5	t3-t6
16	SC05340140	SB16	SC05332710	t2-t8	t7.5	t3-t6
18	SC05340150	SB18	SC00000223	t2-t8	t7.5	t3-t6
19	SC05340170	SB19	SC05332740	t2-t8	t7.5	t3-t6
20	SC05340160	SB20	SC05352510	t2-t8	t7.5	t3-t6

○ Oblong punching						
Punch		Die		Cutting material		
				Tensile Mild Steel (65,000 psi)	Channel	Tensile Stainless Steel (89,000 psi)
Hole diameter (mm)	Part No.	Hole diameter (mm)	Part No.	Thickness		
6.5 x 10	SC05340200	6.5 x 10B	SC00000244	t2-t6		t3-t4
6.5 x 13	SC05340210	6.5 x 13B	SC00000246	t2-t6		t3-t4
8.5 x 13	SC05340220	8.5 x 13B	SC00000248	t2-t6		t3-t4
8.5 x 17	SC05340230	8.5 x 17B	SC00000250	t2-t6		t3-t4
9 x 13.5	SC05340240	9 x 13.5B	SC00000252	t2-t6		t3-t4
9 x 18	SC05340250	9 x 18B	SC00000254	t2-t6		t3-t4
10 x 15	SC05340260	10 x 15B	SC00000256	t2-t8	t7.5	t3-t6
10 x 20	SC05340270	10 x 20B	SC00000258	t2-t8	t7.5	t3-t6
11 x 16.5	SC05340280	11 x 16.5B	SC00000260	t2-t8	t7.5	t3-t6
12 x 18	SC05340290	12 x 18B	SC00000262	t2-t8	t7.5	t3-t6
13 x 19.5	SC05340300	13 x 19.5B	SC00000264	t2-t8	t7.5	t3-t6
14 x 21	SC05340310	14 x 21B	SC00000266	t2-t8	t7.5	t3-t6

### Work stand

Part No. SC03801080

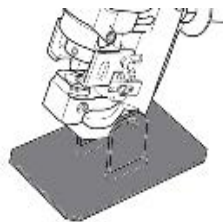

### Slide stopper

Part No. SC03300790

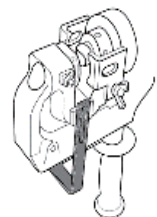

### Hydraulic pressure oil for steel rod cutter / puncher

DPP200, DSC121, DSC162, DSC162R, DSC163, DSC192

Part No. SC00000106  
35mL







Part No. SC00000142  
150mL



# Cordless Tools

## Cordless Inflator Adapter

For Model:  
DMP180, MP100D

Item	Part No.
French valve adapter 	TE00000334
Swim ring adapter 	TE00000333
Ball adapter 	TE00000335
Air chuck 	TE00000796
	TE00000691

## Polishing and Buffing items for Drill

Rubber pad assembly



Collet size	Pad Size	max. rpm	Part No.
6mm	98mm	3,000	123001-2

Wool bonnet



Size	Part No.
100mm	794173-6

Foam polishing pad



Pad Size	Part No.
125mm	794159-0

## Quick charger

(AC only)



Model No.	Charging time (min.) (approx.)	Charger type
CL104D, CL105D, CL111D	180	196832-2

## Tie wire set

Ø0.8mm  
50 pcs/ box



Model No.	TYPE	Wire length / bobbin	Part No.
DTR180	Standard	Approx 100m	199137-9
	Galvanized	Approx 100m	191A57-9
	Poly Coated	Approx 100m	191J59-9

## Wire Guide B



Model No.	Part No.
DTR181	162945-1
	1911H9-6



## For DRC200

Side brushes



Power brush



Boundary Line Tape



Turn brush cover



Filter



Description	Part No.
Side Brushes	SH00000065
Power Brush	SH00000063
Turn Brush Cover	SH00000064
Filter	SH00000213
Boundary Line Tape	SH00000231

## For DRC300

Side brushes



Magnet Tape Set



Filter



Main Brush Complete



Sponge Sheet Set



Bottom Plate Assembly



Description	Part No.
Side brushes	191P28-6
Side brushes	191P26-0
Filter	191P31-7
Sponge Sheet Set	191X35-7
Magnet Tape Set	191P18-9
Main Brush Complete	191P22-8
Main Brush Complete	191P20-2
Bottom Plate Assembly	191P24-4



## Extension handle kit



Model No.	Part No.
DTR180	191M27-0
DTR181	191M27-1

# Cordless Tools

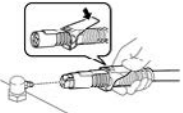
## Nozzle for DGP180

Item	Part No.
  <ul style="list-style-type: none"> <li>■ NPT1/8</li> <li>■ ~69MPa</li> </ul>	191A76-5
 <ul style="list-style-type: none"> <li>■ ~69MPa</li> </ul>	191A77-3
 <ul style="list-style-type: none"> <li>■ NPT1/8</li> <li>■ ~69MPa</li> </ul>	191A78-1

## Hose for DGP180



Item	Length	Part No.
Flexible hose 600	0.6m	191A80-4
Flexible hose 1200	1.2m	191A79-9

## Barrel and Cartridge Barrel for DGP180

Item	Size	Part No.
	For 400g grease cartridge	191B12-7
	For 450g grease cartridge	122D17-8
	For 500g grease cartridge	191F23-6
	For 400g grease cartridge	191F24-4

## Shoulder strap for DGP180



Item	Part No.
Shoulder Belt	166094-6

## Cordless rivet gun

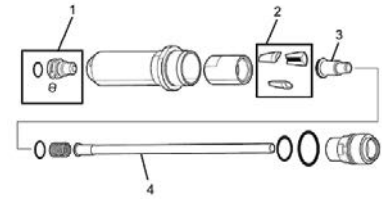

For DRV150

Items	1	2		3		4	
	Nose piece assy	Jaw (3pcs set)		Jaw pusher assy		Pipe	
Rivet Size	Part No.	Marking on jaw	Part No.	Color Size	Part No.	Color Size	Part No.
ø2.4 mm (3/32")	127230-9	4.8	199731-7	Gray 1.9	127478-3	Silver 2.2	162747-5
ø3.2 mm (1/8")	127229-4			Black 2.5	127477-5	Black 2.6	162746-7
ø4.0 mm (5/32")	127228-6			Gray 3.1	127476-7	Pipe is not necessary for operation.	
ø4.8 mm (3/16")	127225-2			Black 3.6	127475-9		

Accessory set

Size	Part No.	Size	Part No.
for 2.4	1911U6-3	B set for 4.0	1911U1-3
for 3.2	1911U4-7	B set for 4.8	1911T9-0

For DRV250

Items	1	2		3		4	
	Nose piece assy	Jaw (3pcs set)		Jaw pusher assy		Pipe	
Rivet Size	Part No.	Marking on jaw	Part No.	Color Size	Part No.	Color Size	Part No.
ø2.4 mm (3/32")	127230-9	4.8	199731-7	Gray 1.9	127478-3	Silver 2.2	162747-5
ø3.2 mm (1/8")	127229-4			Black 2.5	127477-5	Black 2.6	162746-7
ø4.0 mm (5/32")	127228-6			Gray 3.1	127476-7	Silver 3.4	162745-9
ø4.8 mm (3/16")	127225-2			4.8 / 6.4	199731-7 / 199730-9	Black 3.6	127475-9
ø6.0 mm (7/32")	127224-4	6.4	199730-9	Gray 4.0	127474-1		
ø6.4 mm (1/4")	127223-6	6.4		Black 4.5	127473-3	Silver 4.5	162743-3

Accessory set

Size	Part No.	Size	Part No.
for 2.4	1911U6-3	B set for 4.8	1911T9-0
for 3.2	1911U4-7	for 6.0	1911V0-2
A set for 4.0	191F80-4	for 6.4	191C02-6
A set for 4.8	191F79-9		

## Jaw grease for maintenance ( Grease to jaw case & jaws)



Description	Size	Part No.
Molybdenum disulfide grease	5g	191D57-7



# Cordless Tools

## Bulb

(2 pcs. / set)



Model No.	Voltage	Part No.
DML184	14.4V,18V	B-07303

## Light stand (Tripod)

GM00001381



GM00002073



Model No.	Height	Description	Set Screw	Part No.
DML805	992-1,750mm	Up to two DML805's can be mounted.	M8	GM00001381
DML809 DML811	1,300-2,000mm	Up to two lights can be mounted.	M10 bolt & nut	GM00002073

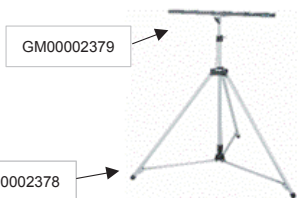

GM00002379

GM00002378

Model No.	Height	Description	Set Screw	Part No.
DML809, DML811, ML003G, ML005G, ML009G	1,300-2,000mm	-	-	GM00002378
DML809, DML811, ML003G, ML005G	Flat bar	Up to two lights can be mounted.	M10 bolt & nut	GM00002379

## Vise

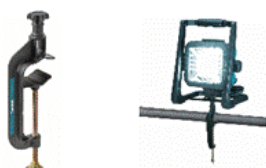

Model No.	Description	Set Screw	Part No.
DML805, ML003G, ML005G, ML009G	Use for mounting on a scaffolding pipe, etc.	M8	GM00001396

## Peripheral Attachment

For heavy DC Impact Wrenches



Part No

346949-3

## Battery protector

Designed to protect the battery cartridge from dust and dripping water in outdoor applications or harsh environments.



Model No.	For Battery	Part No.
DDF458, DHP458, DTD146	BL1815N, BL1820, BL1830B, BL1840B, BL1850B, BL1860B	195798-3

## Tool catcher set (with shoulder belt)



Model No.	Part No.
DTD134, DTD137, DTD138, DTD148, DTD149, DTD152, DTD170, DTS130, DTS131, DTS141, DTW152, DTW190, DTW250, DTW251, DTW253, DTW284, DTW285, DTW300, DTW301	197941-0

## Tool catcher hook set

Enables to hook the machine quickly on a snap hook of waist belt.



Model No.	Part No.
DTD157, DTW300, DTW301, TW004G, TW005G	191K57-9
DTD134, DTD137, DTD146, DTD148, DTD153, DTD154, DTD155, DTD170, DTS130, DTS131, DTS141, DTW152	197043-2
TD001G	191F58-7
AS001G, DCO181, DTD171, DTS141, DTW190, TD126D, TD127D	195779-7
AS001G, DCO181, DTD171, DTS141, DTW190, TD126D, TD127D	195779-7
AS001G, DCO181, DTD171, DTS141, DTW190, TD126D, TD127D	195779-7
DF0300, HP0300, TD0101, TD0101F	194759-0
DHR171, DHR182, HR140D, HR166D, DSD180, SD100D, DJR189	197224-8
DTW190, DTW251, DTW300, DTW301, DTW302	197940-2
DHK180, HR001G, HR002G, HR003G, HR004G	191C37-7
HR007G, HR008G, HR009G	191W90-3
DHR183, HR010G	1911K0-5
DCS553	199296-9
DHS780, DHS781, DHS782, DHS783, HS003G, HS004G	199386-8
JR3051T	191C05-0
DPB183, DPB184	191G64-8

# Cordless Tools

## Battery adapter & Battery converter

PDC01



BAP182



BCV01



BAP18C



Type	Battery type	For Model
<b>PDC01</b> 191A62-6 191A67-6	LXT 18V Battery x4	LXT 18V Models LXT 18Vx2 Models or Direct connection 36V Models
<b>BAP182</b> 197581-4	LXT 18V Battery x2	LXT 18Vx2 Model
<b>BCV01</b> 195511-9	LXT 18V Battery x2	Old 36V Models
<b>BAP18C</b> 191M50-5	LXT 18V Battery	LXT 18V

## Battery adapter for PDC01 & LXT 18V Battery models

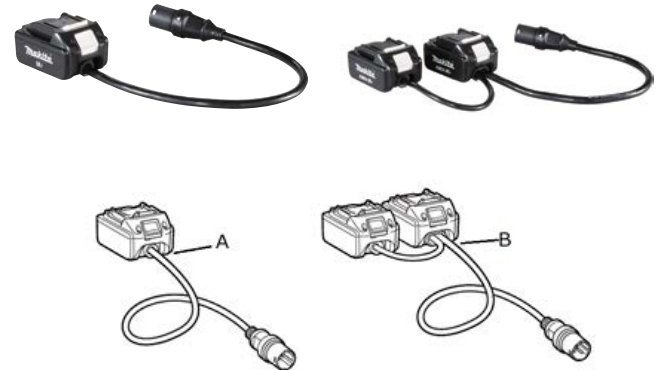

## Harness for BAP182/ BCV01

Harness

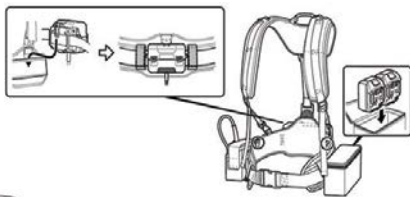

Shoulder Belt



Type	Part No.
Shoulder Belt	162523-7

Item	Part No.
A	191A53-7
B	191J51-5

## Blower harness for PDC01 / PDC1200

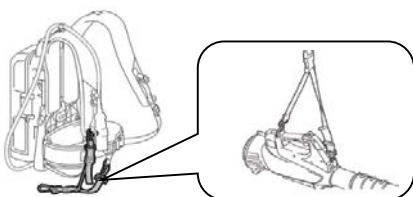

Part No.
191J48-7

## Battery adapter for PDC01/ PDC1200 & XGT 40VMax Battery models







Item	Part No.
C	191N62-4

# Cordless Tools

## Coffee Maker accessories

For model:  
DCM501



Item	Part No.
Cup cover 	KF00000021
Cup 	KF00000020
Filter 	KF00000013
Spoon 	KF00000033

## Torque adjust tool



Model No.	Part No.
BFH040/F, BFH090/F, BFH120F, DFL020F, DFL061F, DFL062F, DFL063F, DFL082F, DFL083F, DFL122F, DFL123F, DFL125, DFL201F, DFL201R, DFL202F, DFL204F, DFL300F, DFL301F, DFL301R, DFL302F, DFL400F, DFL402F, DFL402R, DFL403F, DFL651F, DFT022F, DFT023F, DFT024F, DFT025F, DFT041R, DFT043F, DFT044F, DFT045F, DFT046F, DFT060F, DFT082F, DFT082R, DFT083F, DFT084F, DFT085F, DFT086F, DFT124F, DFT124R, DFT125F, DFT126F, DFT127F, DFT128F	765027-4

## Magnetic Adapter Attachment



Model No.	Part No.
ML104, ML105, ML106	GM00001714

## Strap



Model No.	Part No.
DML812	GM00002239



## Lamp shade



Model No.	Part No.
DML809	GM00002286
DML811	GM00002287
ML005G	GM00002377
ML009G	GM00002358

## Anti-glare film



Model No.	Part No.
ML003G	GM00002312
ML005G	GM00002359
ML009G	GM00002376

## Ring 25

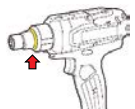

Model No.	Color	Part No.
DFT085F, DFT086F, DFT127F, DFT128F	Black	424977-9

## Lock nut M28

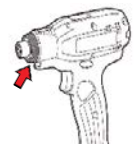

Model No.	Color	Part No.
DFT023F, DFT024F, DFT025F, DFT045F, DFT046F, DFT060F	Black	457530-6

## Protector



Protects tool from scratches and damages.

Description	Model No.	Part No.
Protector set a white	DRV150	191G65-6
Protector set b white	DRV250	191G66-4

# Cordless Tools

## Keyless drill chuck



### DC Models

Model No.	Capacity	Thread size	with Package	Bulk
			Part No.	Part No.
DA331D	0.8-10mm	3/8-24 UNF	196308-9	766007-3
DA333D, DF330D	0.8-10mm	3/8-24 UNF	191A86-2	763228-8
DDA351	0.8-10mm	3/8-24 UNF	---	766005-7
DF332D, DF333D, HP332D, HP333D	0.8-10mm	3/8-24 UNF	---	763238-5
DF347D	0.8-10mm	1/2-20 UNF	---	763243-2
HP330D, HP347D	0.8-10mm	1/2-20 UNF	191A87-0	763229-6
DF001G, DDF458, DDF481, DDF486, HP001G, DHP458, DHP481, DHP486	1.5-13mm	1/2-20 UNF	---	763252-1
DDF458, DDF486, DDF489, DHP458, DHP486, DHP489	1.5-13mm	1/2-20 UNF	---	763261-0
DDF453, DF457D, DF488D, DHP453, HP457D, HP488D	1.5-13mm	1/2-20 UNF	196306-3	766004-9
DF488D, HP488D	1.5-13mm	1/2-20 UNF	---	763260-2
DDF451, DHP451	1.5-13mm	1/2-20 UNF	---	763191-5 763196-5
DDF453, DDF482, DDF484, DDF485, DDF487, DF002G, DF457D, DHP453, DHP482, DHP484, DHP485, DHP487, HP457D	1.5-13mm	1/2-20 UNF	199154-9	766027-7
DDF487, DF002G, DHP482, DHP487, HP002G	1.5-13mm	1/2-20 UNF	---	763262-8
DDF483, DHP483	1.5-13mm	1/2-20 UNF	---	763241-6

### AC Models

Model No.	Capacity	Thread size	with Package	Bulk
			Part No.	Part No.
DP2011	0.8-6.5mm	3/8-24 UNF	193203-4	763156-7
6408, DA3011, DA3011F	0.8-10mm	3/8-24 UNF	192016-0 192034-8 (USA)	763132-1
6408	1.5-10mm	3/8-24 UNF	192890-6	763186-8
6413	0.8-10mm	3/8-24 UNF	---	763242-4
DF0300, HP0300	1.0-10mm	1/2-20 UNF	---	766012-0
DP3003	0.8-10mm	1/2-20 UNF	193226-2 193227-0(USA)	763144-4
DP4001, DP4003	1.5-13mm	1/2-20 UNF	192956-2 192957-0(USA)	763140-2
DP4011, HP2050, HP2050F, HP2051, HP2051F, HP2070, HP2070F, HP2071, HP2071F	1.5-13mm	1/2-20 UNF	194254-0	763195-7
6300-4, DP4700	1.5-13mm	1/2-20 UNF	192892-2	763130-5
HP1631, HP1641, HP1641F	1.5-13mm	1/2-20 UNF	196193-0	766017-0

## Drill chuck

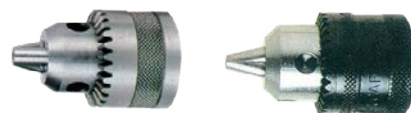

\*with Chuck key

\*\*without Chuck key

\*\*\*without key with hex.socket head bolt M6X25 & nord-lock washer 6 x2

\*\*\*\*without key with hex. socket head bolt M6X25 & spring washer 6 press fit

### DC Models

Model No.	Drill chuck				Chuck key
	Capacity (mm)	Thread size	with Package Part No.	Bulk Part No.	Part No.
DDA350	1.5-10	---	---	763174-5	763415-9
DDA450	2.0-13	1/2-20 UNF	*193822-6	763183-4	763259-7 (763430-3)
DA001G, DDA460, DG001G, DDG460	2.0-13	---	---	763250-5	763251-3

### AC Models

Model No.	Drill chuck				Chuck key
	Capacity (mm)	Thread size	with Package Part No.	Bulk Part No.	Part No.
DD2020, DP2010	6.5	3/8-24 UNF	**192887-5	763077-3	763418-3
	6.5	3/8-24 UNF	**192888-3		
6407	0.8-10	3/8-24 UNF	---	763136-3	763423-0
6412	1.5-10	3/8-24 UNF	---	763079-9	763418-3
6411, 6412	1.5-10	3/8-24 UNF	---	763244-0	763447-6
HP1230	1.5-10	3/8-24 UNF	192879-4	763067-6	763415-9
HP1630	1.5-13	1/2-20 UNF	*195430-9	763161-4	763441-8
HP1630, HP1640, HP1640F	1.5-13	1/2-20 UNF	*196008-1	766016-2	763448-4
DP4000, DS4011, DS4012, HP2050, HP2050F, HP2051, HP2051F, HP2070, HP2070F, HP2071, HP2071F	2.0-13	1/2-20 UNF	*193822-6	763183-4	763430-3 (763259-7)
6300-4, 6300T, 6305, DP4002, DP4700, DS4011, DS4012, 8406, 8406C, HP2010N, HP2032, HP2050, HP2070	2.0-13	1/2-20 UNF	**192877-8	763047-2	763432-9 798341-3
DA3010, DA3010F	1.5-10	---	---	763174-5	763415-9
6302H, 6303H, DP4000, DP4002	2.0-13	1/2-20 UNF	---	763145-2	763434-5
DP4010, HP2050, HP2050F, HP2051, HP2051F,	2.0-13	1/2-20 UNF	*193067-6	763147-8	763430-3
6300-4, DP4700, DS5000, HP2070, HP2070F	4.5-16	1/2-20 UNF	---	763066-8	763432-9
DS5000	3.0-16	1/2-20 UNF	---	763254-7	763443-4
6304LR, DA4000LR, DA4031, DS4000	1.5-13	---	---	763160-6	763434-5
		(Press fit)	193319-5		
6304LR, DA4000LR	2.0-13	---	---	763159-1	763432-9 / 798341-3
		(Press fit)	193318-7		
DA4031	2.0-13	---	---		
		(Press fit)	193519-7		

# Drilling / Fastening

## Drill chuck assembly for Impact Driver



Type	Chuck Type	Part No.
44 NZ	Keyless	192121-3
44 NZ	Chuck & Key Set	198913-8

## Angle attachment

(For drilling in close quarters, incorners, between joists and studs.)



Model No.	No Load Speed	Part No.
DS4010, DS4011, DS4012	High: 800rpm Low: 350rpm	STEX122177
DA4000LR	High: 900rpm Low: 400rpm	193316-1

## Type 43 drill stand

For Neck diameter 43mm Models



Part No.

A-36712

## Grip assembly



Model No.	Part No.
6906	122464-9
TW1000	122727-3

## Extension handle

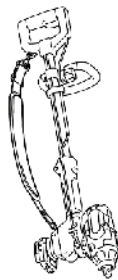

Model No.	Part No.
DTW700, DTW701, DTW800, DTW1001, DTW1002, TW001G, TW007G, TW008G	191G67-2

## Shear wrench sleeve

For Model  
6922NB DWT310



\*Type F (for HEXA TECH (GFD France))

Bolt Size	Outer sleeve			Inner sleeve	
	Hex size	L (mm)	Part No.	L (mm)	Part No.
M16	27	35	764362-7	36	764416-0
		81	764367-7	36	*764421-7
		100	764406-3	82	764356-2
M16			100	764400-5	
M20	32	37	764361-9	38	764417-8
M20		37	764361-9	38	*764422-5
M20		83	764363-5	84	764357-0
M20		100	764408-9	100	764402-1
M22, 7/8"	36 1-7/16"	39	153909-6	39	764418-6
M22, 7/8"		85	764364-3	39	*764423-3
M22, 7/8"		100	764410-2	85	764352-0
M22, 7/8"		170	764365-1	100	764404-7
3/4"	1-1/4"	37	764361-9	170	764354-6
3/4"		83	764363-5	38	764419-4
3/4"		168	764366-9	84	764353-8
3/4"				169	764355-4

5/8"  
For Model  
6924N

Bolt Size	Outer sleeve			Inner sleeve	
	Hex size	L (mm)	Part No.	L (mm)	Part No.
M22	36	49	194033-6	48	194310-6
M24	41	49	194034-4	49	194311-4
7/8"	1-7/16"	49	194092-0	48	194310-6
1"	1-5/8"	49	194034-4	49	194312-2

## Autofeed attachment set

Flat Tape Collated Screws size : 25-55mm



Model No.	Standard Equipment Bit	Part No.
DFS250, DFS452, FS2200, FS2300, FS4000, FS4200, FS4200A, FS4300, FS6200, FS6300, FS6300R	Phillips No.2 Square No.2	199078-9

# Drilling / Fastening

## Bits for Autofeed attachment set

For Attachment set 191G72-9, 191G73-7, 191G74-5



Model No.	Size	Part No.
DFS250, DFS452 FS2200, FS2300, FS4000, FS4200, FS4200A, FS4300, FS6200, FS6300, FS6300R	Phillips No.2 (5pcs)	199155-7

## Magnetic bit holder Type MZ



(For 25mm insert bit (C-Form))

Model No.	Magnetic bit holder	
	Size	Part No.
DFS450, DFS451, FS2300, FS4000, FS4200, FS4300, FS6200, FS6300, FS6300R	6.35-60	784811-8
	6.35-76	784801-1

## Socket bit

1 per pkg.

\*For self drilling screw

\*\*Magnetic socket bit



FS2700



Bolt Size	A (mm)	L (mm)	Type	Part No.
M5	8	55	NZ	784403-3
M6	10	55	NZ	784405-9

Front cap	
Size	Part No.
12	322070-2

## Magnetic socket bit

1 per pkg.

\*Non-magnetic socket bit

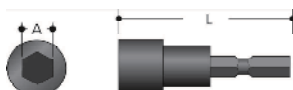

FS2500

FS2701



Bolt Size	A(mm)	L(mm)	Type	Part No.
M5	8mm	65	MZ	*784415-6
1/4"	3/8"	65	MZ	784802-9
M6	10mm	65	MZ	784806-1

# Impact Drilling / Demolition

## Dust cup

(Dust collector assembly)  
(Protects operator from dust and debris)



Bit Dia. (mm)	Part No.
6-14.5	421342-3
12-16	421664-1

## Chuck adapter assembly (1/2"-UNC)

With screw M6 x 22



Part No.
D-14093

## Drill chuck & Chuck key

(Use with chuck adapter)



Description	Part No.
Drill chuck (13mm)	192877-8
Chuck key	763432-9

## Quick change drill chuck set (13mm)



	Model No.	Part No.
DC models	DHR243, DHR264	194079-2
AC models	HR2320T, HR2470T, HR2470FT, HR2630T, HR2631FT, HR2651T, HR2653T, HR2810T, HR2811FT	194079-2
	HR3210FCT	194568-7

## Hammer carrier

For Model:  
HM1812, HM1802, HM1810, HM1801



Part No.
D-54972

## Tool holder set



	Model No.	Part No.
DC models	DHR243, DHR264	194080-7
AC models	HR2320T, HR2470T, HR2470FT, HR2630T, HR2631FT, HR2651T, HR2653T, HR2810T, HR2811FT	194080-7

## Spacer set



Model No.	Part No.
HR008G, HR009G, HR3001C, HR3011FC	191L91-5

## Drill chuck set

(Chuck adapter assembly and Drill chuck)

For model: HR001G, HR002G, HR003G, HR004G, HR007G, HR010G, HR2230, HR2460, HR2470, HR2470F, HR2475, HR2630, HR2631F, HR2652, HR2810, HR3001C, HR3011FC, HR3012FC



\*Inc.chuck key

Shank	Type	Part No.
SDS-PLUS	with key	*194041-7



# Impact Drilling / Demolition

## Vacuum attachment



Model No.	Type	Part No.
HM1304/B, HM1306, HM1307C/CB, HM1317C/CB, HM1400, HM1500/B, HM1801, HM1802, HM1810, HM1812	With Vacuum hose set	197148-8
	Without Vacuum hose set	197168-2

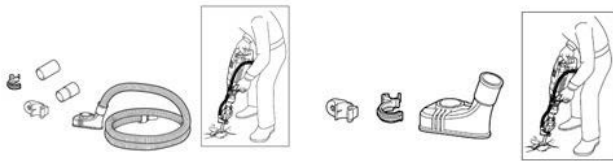

Model No.	Type	Part No.
HM1501, HM1502, HM1511, HM1512	With Vacuum hose set	191M20-4

## Vacuum attachment

SDS-max 40/45mm class vacuum attachment  
Drilling mode  
Hammering mode

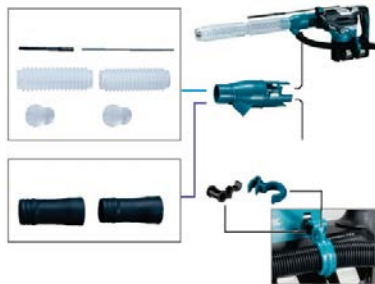

Model No.	Part No.
HR4001C, HR4002, HR4010C, HR4011C, HR4501C, HR4510C,	196074-8
HR5212C , HR5202C	196858-4

## Sealing cap

For Dust extraction system set



Dust Extraction System Set	Part No.
DX05, DX06, DX07, DX08, DX09, DX12, DX14, HR2652, HR2653, HR2653T, HR2663	422784-4
DX16, DHR183, HR010G	422992-7

## Blow-out Bulb

Ideal for blowing out chips and dust from drilled holes before setting anchor fasteners. The efficient design allows for quick debris removal. Bulb is designed for easy one handed operation.



Part No.
765009-6

## Dust extraction system set

This system is designed to collect dust effectively with on-off operation of the tool's on-off trigger switch interlocked with this system.



Model No.	Dust Extraction System Set	Part No.
HR182D	DX05	199658-1
DHR242	DX06	199561-6
DHR281 DHR283	DX09	199583-6
HR3011F, HR008G	DX10	191F95-1
HR3012F, HR009G	DX11	191G00-4
HR001G, HR003G	DX12	191E52-3
HR002G, HR004G	DX14	191E58-1
HR007G, HR2652	DX15	191X39-9
DHR183, HR010G	DX16	1911P2-6

## Dust case

With filter



Model No.	Part No.
DX05	199595-9
DX06, DX07, DX08, DX09, DX12, DX14,	199555-1
HR2652, HR2653, HR2653T, HR2663	199586-0
DX16, DHR183, HR010G	1911P5-0

## Filter

HEPA Filter



Dust Extraction System Set	Part No.
DX01, DX06, DX07, DX08, DX09, DX10, DX11, DX12, DX14, HR2652, HR2653, HR2653T, HR2663	199557-7
DX05	199596-7

## Oil supply & Grease vessel



Model No.	Type	Contents	Part No.	
A	HM1306	VG100	Oil 100 ml	181118-7
B	Hammers (for bit)	-	Grease 30ml	188088-1



# Impact Drilling / Demolition

## Depth Gauge for Hammer Drills

(Stopper pole)



	Model No.	Part No.
AC models	HP1630, HP1631, HP1640/F, HP1641/F, HP2050/F, HP2051/F, HP2070/F, HP2071/F	324219-0

## Standard type side grip

\*Side grip



Model	Standard type side grip	
	Part No.	
HR3540C, HR3541FC, HR4001C, HR4002, HR4010C, HR4011C, HR4501C, HR4510C, HR4511C	135265-6	
HR5000	273472-4	

## Dustcup set item



Model No.	Part No.
DHR165, DHR171, DHR182, HR140D, HR166D, HR1830, HR1840, HR1841F, HR2800, HR2810, HR2811F, HR2230, HR2460, HR2460F, HR2470, HR2475, DHR202, DHR241, DHR263	198362-9
DHR242, HR2650, HR2651, HR2652, HR2653, HR2661, HR2663, DHR281, DHR283, HR002G, HR004G, HR3012FC	195173-3
DHR243, HR2651T, HR2653T, HR2300T, HR2320T, HR2630T, HR2631FT	195179-1

## Grip base set Item



Part No.	Item	Part No.
194581-5	Hex. Bolt M8X110	921919-9
194583-1	Grip base 20	419975-6
	Hex. Bolt M8X110	921919-9
194582-3	Grip base 20	419975-6
	Hex. Bolt M8X110	921919-9

## Side Grip

(Hammer)



Model No.	Part No.
HR006G, HR5202C, HR5212C	135283-4
HM001G, HM0870C, HM0871C	136362-1
HM002G, HM1202C, HM1203C, HM1205C, HM1213C, HM1242C	135269-8
HM1214C	135283-4

## Hammer service kit

A: With Slide-Chuck System  
B: With Swivel-Chuck System



Model No.	Part No.
DC Models	
DHR182	199544-6
HR005G	191N29-2
HR010G	199544-6

AC Models

HM0860C	195204-8
HM1202, HM1202C	193391-7
HM1307C, HM1307CB, HM1317C, HM1317CB	195103-4
HR4001C, HR4002, HR4010C, HR4011C	195195-3
HR4501C, HR4510C, HR4511C	195210-3
HR2800, HR2810, HR2810T, HR2811F, HR2811FT	195206-4
HR4002	195195-3







# Blower Accessories

## Cordless Dust Blower accessories

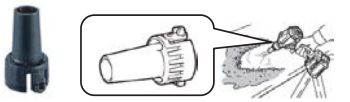
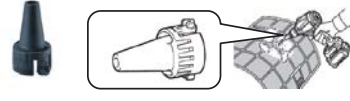
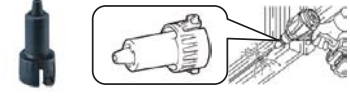
For model:

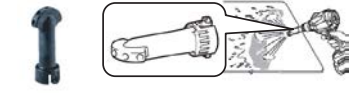
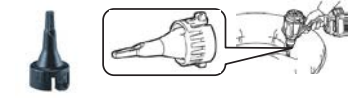
AS001G, DAS180

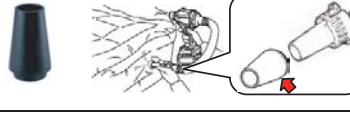
\*1 used by attaching to Nozzle 13 and Air vent hose

Item	Description	Part No.
<p>Nozzle 13 set</p> 	<p>Nozzle diameter: <math>\varnothing</math>13mm Nozzle diameter: <math>\varnothing</math>13mm (Same as the caliber of the machine)  <ul style="list-style-type: none"> <li>• For blow-off works</li> <li>• For inflating large play pools, etc.</li> </ul> </p>	191X15-3
<p>Nozzle 7 set</p> 	<p>Nozzle diameter: <math>\varnothing</math>7.0mm For filter cleaning</p>	191X13-7
<p>Nozzle 3 set</p> 	<p>Nozzle diameter: <math>\varnothing</math>3.0mm</p>	191X11-1
<p>Flexible nozzle complete set</p> 	<p>Nozzle diameter: <math>\varnothing</math>6.0x800 (Hose) For blowing dust away from OA equipment or narrow spaces where this machine cannot enter</p>	191X21-8
<p>Wide range nozzle set</p> 	<p>Nozzle diameter: <math>\varnothing</math>6.0mm (each hole) For wide range blow-off</p>	191X19-5
<p>Pinch valve nozzle set</p> 	<p>Nozzle diameter: <math>\varnothing</math>7.0mm For inflating/deflating inner tubes and beach balls</p>	191X17-9
<p>Long nozzle set</p> 	<p>Nozzle diameter: <math>\varnothing</math>8.0mm  <ul style="list-style-type: none"> <li>• For cleaning anchor holes</li> <li>• For cleaning narrow spaces that are out of reach</li> </ul>                     Nozzle 13 set (191X15-3) is also necessary.                 </p>	191X78-9
<p>Air vent hose complete set</p> 	<p>Nozzle diameter: 13mm (Same as the caliber of the machine) For inflating/deflating inner tubes and beach balls (Remove Dust cap complete from the machine and attach this hose.)</p>	191X23-4
<p>Rubber attachment 20-30 set</p> 	<p>Nozzle diameter: 7.0mm For deflation large play pools and inflatable beds etc.*1 Air vent hose complete set (191X23-4) and nozzle 13 set (191X15-3) are also necessary.</p>	191X25-0
<p>Rubber attachment 65 set</p> 	<p>Nozzle diameter: <math>\varnothing</math>65mm For deflating futon (bedding) compression bag*1 Air vent hose complete set (191X23-4) and nozzle 13 set (191X15-3) are also necessary.</p>	191X27-6
<p>Filter C complete set</p> 	<p>For use of the machine in a dusty environment (Remove Dust cap complete from the machine and attach this Filter.)</p>	191X29-2

# Cutting (New Material / Masonry)

## Rip fence (Guide rule)

\*Use with wing bolt M5 x 10 (P/N 924206-5)  
 \*\*Use with wing bolt M6 x 14 (P/N 265701-9)



Model No.	Part No.
4100KB*, 4100NB*, 4100NH*, 4101R*, 4101RH*, 4105KB*, 4131**, 4157KB, 5057KB	164095-8
CA5000	165447-6

## Base set

(To set cutting depth)



Model No.	Part No.
4114, 4114S	165431-1

## Portable band saw stand, Cover & Stand chain vise, Cover set

(For accurate square cutting operations)



Model	Description	Part No.
DPB182	Cover	197975-3
2107F	Cover	196325-9



## Hook



Model	Description	Part No.
DPB183, DPB184	HOOK assembly	191G64-8

## Side grip

(Handle)



Model	Thread Size	Description	Part No
DPB183	M8	Rubbierized grip	158237-4

## Cutting wax for band saw



Part No.
191897-9

# Cutting (New Material / Masonry)

## Shear



Model No.	Item No.	Description	Part No.
DJS130, JS1300	2	---	792742-7
	3	---	792743-5
DJS800	2,5	1pc	725130-3
DJS160, DJS161, JS1601	1	2 pcs set	792533-6
	2	---	792534-4
JS1602	1-3 set	---	191383-0
JS3201	---	Thickness gauge 1.0/1.5/2.0mm	762007-1

## Nibbler

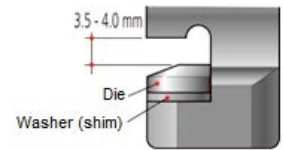

\*\*To keep clearance of 3.5 to 4.0mm, use a washer(shim) or two under the die when installing a resharpended die.

Model No.	Item no.	Description	Part No
DJN160, DJN161, JN1601	1	Die	A-15051
	2	Punch	A-83951
JN3201	1	Die	792292-2
	2	Punch	792728-1
	---	Washer (shim)**	341796-7**
	3	Wrench	781019-5



# Grinding / Sanding

## Wheel guard

Bearing box type  
 A: Triple notches  
 B: Single notch  
 C: Twin notches  
 D: 5 notches

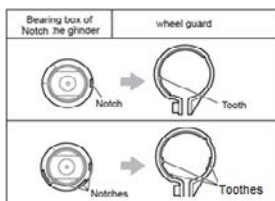

\*Toolless type

\*\*UP to 180mm size cup diamond wheel

\*\*\*Inner flange 45CA/42CB/45CC is also necessary.

\*\*\*\*Inner flange 47(P/N:122482-7) is also necessary.

\*\*\*\*\*Inner flange 47(P/N:126601-7) is also necessary.

\*\*\*\*\*Wheel Size Down 125mm → 115mm

\*\*\*\*\*Lo profile type

Wheel Size	Models	Bearing box type	for Abrasive cut-off wheel (Type:42)		Attachment for Abrasive cut-off wheel (Type:42)	Dust collection wheel guard for diamond wheel		Dust collection wheel guard for cup diamond wheel	
			Type	Part No.		Type	Part No.		
100mm	---	Triple notches	Standard 100CK	122909-7	---	---	---	---	
	---	Single notch	Standard 100	192626-3	---	A	198413-8	---	
	9500N, 9500NB	Single notch	Standard 100	---	---	C	199295-1	---	
	GA4050, GA4050R	5 notches	New Toolless 100C	162555-4*	---	A	192212-0	---	
115mm	---	Triple notches	Standard 115CK	122910-2	199709-0	---	---	195239-9(EU)	
	---	Single notch	Standard 115	---		---	---	195237-3	
	GA4550, GA4550R, GA4552, GA4552R	5 notches	New Toolless 115C	162556-2		---	---	---	
125mm	GA5010, GA5020C, GA5021C, 9565C, 9565CV, 9565CVR, 9565P	Single notch	---	---	199710-5	B	192968-5	195237-3	
	---	---	---	---		C	196846-1		
	9005B, 9005BZ	Triple notches	Toolless 125CK	122905-5		A	198416-2	---	
	---	---	Standard 125CK	122911-0		---	---	---	
150mm	GA5050, GA5050R, GA5052, GA5052R	5 notches	New Toolless 125C	162557-0	---	---	---	191F81-2	
	---	---	---	---		C	191G06-2		
180mm	GA6010, GA6020, GA6020C, GA6021, GA6021C, GA6040, GA6040C, GA6040R, 9566C 9566CR, 9566CV, 9566CVR, 9566PCV	Triple notches	Standard 150CK	122912-8	---	---	---	---	
	GA7010C, GA7011C, GA7012C, GA7020, GA7020R, GA7020S, GA7021, GA7030, GA7030R, GA7030S, GA7031, GA7040, GA7040R, GA7040S, GA7050, GA7050R, GA7060, GA7060R, GA7061, GA7061R, GA7062, GA7062R, GA7063, GA7063R, GA7064	Triple notches	Standard 180CK	122914-4	---	---	D	198514-2	---
230mm	GA7010C	Single notch	---	---	---	B	194303-3	195387-4	
	GA9010C, GA9012C, GA9020, GA9020R, A9020S, GA9030, GA9030R, GA9030S, GA9031, GA9040, GA9040R, GA9040S, GA9050, GA9050R, GA9060, GA9060R, GA9061, GA9061R, GA9062, GA9062R, GA9063, GA9063R	Triple notches	Standard 230CK	122913-6	---	---	D	198440-5(EU)	---
	9069	Single notch	---	---	---	B	194044-1	---	
	GA9020, GA9020, GA9020S, GA9030, GA9030S, GA9040S	Twin notches	---	---	---	B	194044-1	195387-4**	
	---	---	---	---	---	D	198380-7	195388-2**	
230mm	GA9020, GA9031, GA9040S, GA9050, GA9050R, GA9060, GA9060R, GA9061R, GA9062, GA9063R	Triple notches	Standard 230CK	122913-6	---	---	---	---	
	GA9020, GA9020S, GA9040S	Twin notches	---	---	---	D	198380-7****	195387-4**	

# Grinding / Sanding

## Cordless Models

\*\*UP to 180mm size cup diamond wheel

\*\*\*Inner flange 45CC (P/N:198678-2(EU) / 198675-8) is also necessary.

\*\*\*\*Inner flange 45CA (P/N:198676-6) is also necessary.

\*\*\*\*\*Inner flange 42CB (P/N:198677-4) is also necessary

Wheel Size	Models	Bearing box type	for Abrasive cut-off wheel (Type:42)		Attachment for Abrasive cut-off wheel (Type:42)	Dust collection wheel guard for diamond wheel		Dust collection wheel guard for cup diamond wheel
			Type	Part No.		Type	Part No.	Part No.
100mm	DGA402	Single notch	Standard 100	192626-3	---	A (C)	198413-8	---
						C	199295-1	
	GA003G, GA006G, GA011G, GA014G, GA021G GA024G, GA027G, GA030G	5 notches	New Toolless 100C	162555-4	---			
115mm	DGA450, DGA452, DGA454, DGA455, DGA456, DGA458, DGA461, DGA462, DGA463, DGA464, DGA467, DGA468	Triple notches	Standard 115CK	122910-2	199709-0	---	---	195239-9(EU)
	DGA452	Single notch	Standard 115	---		---	---	195237-3
	GA004G, GA007G, GA012G, GA015G,	5	New	162556-2		---	---	---
125mm	DGA504, DGA505, DGA506, DGA508, DGA511, DGA512, DGA513, DGA514, DGA517, DGA518	Triple notches	Standard 125CK	122911-0	199710-5	A (CD)	198416-2	195239-9(EU)
			Toolless 125CK	---		C (K)	---	
	GA005G, GA008G, GA013G, GA016G, GA023G, GA026G, GA029G, GA032G	5 notches	New Toolless 125C	162557-0		C	191G06-2	191F81-2
180mm	GA7010C, GA7011C, GA7012C, GA7020, GA7020R, GA7020S GA7021, GA7030, GA7030R, GA7030S, GA7031, GA7040, GA7040R, GA7040S, GA7050, GA7050R, GA7060, GA7060R, GA7061, GA7061R, GA7062, GA7062R, GA7063, GA7063R, GA7064	Triple notches	Standard 180CK	122914-4	---	D (K)	198514-2****	---
					---	---	---	
230mm	DGA900, DGA901	Triple notches	Standard 230CK	122913-6	---	D (K-C) (K)	198440-5 (EU)***	---

## Wheel guard for X-LOCK Models

Wheel Size	Models	Bearing box type	for Abrasive cut-off wheel (Type:42)		Attachment for Abrasive cut-off wheel (Type:42)	Dust collection wheel guard for diamond wheel		Dust collection wheel guard for cup diamond wheel
			Type	Part No.		Type	Part No.	Part No.
100mm	DGA419, DGA420	X-LOCK	X-LOCK 100C	162706-9	---	---	---	---
115mm	DGA469	X-LOCK	X-LOCK 115C	162707-7	199709-0	---	---	---
125mm	DGA519, DGA521	X-LOCK	X-LOCK 125C	162708-5	199710-5	C	191G05-4	---

# Grinding / Sanding

## Wheel guard for wire brush



For Models	Bearing Box Type	For Wire Cup Brush		For Wire Bevel Brush	
		Cup size	Part No.	Size	Part No.
100mm Angle grinder	Single notch	75mm	192454-6	85mm	192412-2
115mm Angle grinder		90mm	193066-8	---	---

## Side Grip and Loop handle for Angle Grinder



Angle grinder  
\*with bolt & wrench

Wheel Size	Models	Thread Size	Standard	Rubberized	Anti Vibration
100mm	GA4030, GA4030R, GA4031, GA4032, GA4034	M8	153504-2	158237-4	194514-0
	GA4030, GA4030R, GA4031, GA4034, GA4040, GA4040C, GA4041C, 9553B, 9553HB, 9553HN, 9556HB, 9556HN, 9556HP, 9556NB, 9556PB	M8	153489-2	158237-4	194514-0
	GA4050, GA4050R, GA4051R	M8	---	158237-4	194514-0
	9500N	M8	---	158237-4	194514-0
	GA4030	M8	153504-2	---	---
115mm	GA4530, GA4530R, GA4534	M8	153504-2	158237-4	194514-0
	GA4542C, GA4543C	M8	---	158237-4	194514-0
	GA4540, GA4540C, GA4540R, GA4541, GA4541C, GA4541R, 9554HN, 9557HN, 9557HNR, 9557HP, 9564CV, 9564CVR, 9564CR, 9564C, 9561CVR, 9561CR, 9564HR, 9564H, 9554HN, 9564P, 9564PC, 9564PCV, GA4550, GA4550R, GA4551R, GA4552, GA4552R, GA4553R	M8	153489-2	158237-4	194514-0
	GA4530, GA4534	M8	153504-2	---	---
	9564P	M8	153489-2	---	---
	9564PC, 9564PCV	M8	153489-2	158237-4	---
	GA5010, GA5020, GA5020C, GA5021, GA5021C	M8	153504-2	158237-4	194514-0
125mm	GA5030, GA5030R, GA5034, GA5040, GA5040C, GA5040R, GA5041C, GA5041R, GA5042C, GA5043C, 9555B, 9555HN, 9558HN, 9558HNR, 9558HP, 9558NB, 9558NBR, 9565P, 9558PB, 9565CV, 9565P, 9565PC, 9565PCV	M8	153489-2	158237-4	194514-0
	GA5050, GA5050R, GA5051R, GA5052, GA5052R, GA5053R	M8	---	158237-4	194514-0
	9565C, 9565CV, 9565H	M8	---	158237-4	194514-0
	9005B, 9005BZ, 9005N, 9015B	M12	152492-0	---	---
	GA5010	M8	153504-2	---	---
	GA5020	M8	153504-2	158237-4	---
	GA5020C	M8	---	158237-4	194514-0
	GA5030	M8	153504-2	---	---
	9565PC, 9565PCV	M8	153489-2	158237-4	---
	GA6010, GA6011, GA6020, GA6020C, GA6021, GA6021C	M8	153504-2	158237-4	194514-0
150mm	GA6040, GA6040C, 9566CV, 9566PC	M8	153489-2	158237-4	194514-0
	GA6042C	M8	---	158237-4	194514-0
	9006N	M12	152492-0	---	---
	GA6010	M8	153504-2	---	---
	GA6020	M8	153504-2	158237-4	---
	GA6020C	M8	---	158237-4	194514-0
	GA6042C	M8	---	158237-4	---
	9566PC	M8	153489-2	158237-4	---

# Grinding / Sanding

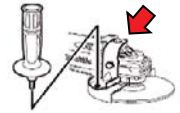

\*with bolt, without grip

Wheel Size	Models	Thread Size	Standard	Rubbierized	Anti vibration	Grip Base For Cutting Operation
180mm	GA7911	M12	152492-0	---	---	---
	GA7010C, GA7011C, GA7012C, GA7012C, GA7050, GA7050R, 9067, 9617	M14	152539-0	---	194543-3	---
	GA7020, GA7020R, GA7020S	M14	152539-0	---	194543-3	*194684-5
	GA7030, GA7030R, GA7030S, GA7031, GA7040, GA7040R, GA7040S	M14	---	---	194543-3	*194684-5
	GA7060, GA7060R, GA7061, GA7061R, GA7062, GA7062R, GA7063, GA7063R, GA7064	M14	143486-6	---	194543-3	---
	GA7020, GA7021	M14	152539-0	---	---	*194684-5
	GA7050, GA7010C	M14	152539-0	---	---	---
	GA7060, GA7061, GA7064	M14	143486-6	---	---	---
230mm	GA9010C, GA9012C, GA9050, GA9050R, 9069 9069S	M14	152539-0	---	194543-3	---
	GA9020, GA9020R, GA9020S	M14	152539-0	---	194543-3	*194684-5
	GA9030, GA9030R, GA9030S, GA9031, GA9040, GA9040R, GA9040S	M14	---	---	194543-3	*194684-5
	GA9060, GA9060R, GA9061, GA9061R, GA9062, GA9062R, GA9063, GA9063R	M14	143486-6	---	194543-3	---
	GA9020	M14	152539-0	---	---	*194684-5
	GA9060	M14	143486-6	---	---	---

## Side Grip and Loop handle for Cordless Angle Grinder



\*Applicable models: DGA402

\*\*Applicable models: DGA452

Wheel Size	Models	Thread Size	Standard	Rubbierized	Anti vibration
100mm	DGA402	M8	*153489-2	158237-4	194514-0
	DGA404, DGA405, DGA406, DGA408, DGA411, DGA412, DGA413, DGA414, DGA417, DGA418, DGA419, GA003G, GA006G, GA011G, GA014G, GA021G, GA024G, GA027G, GA030G	M8	---	158237-4	194514-0
115mm	DGA450, DGA452, DGA454, DGA455, DGA458	M8	**153489-2	158237-4	194514-0
125mm	DGA456, DGA461, DGA462, DGA463, DGA464, DGA467, DGA468, DGA469, GA004G, GA007G, GA012G, GA015G, GA022G, GA025G, GA028G, GA031G	M8	---	158237-4	194514-0
	DGA504, DGA505, DGA508	M8	---	158237-4	---
150mm	GA035G, GA036G	M8	---	158237-4	194514-0
180mm	DGA700, DGA701, GA037G	M14	143486-6	---	194543-3
230mm	DGA900, DGA901, GA038G	M14	143486-6	---	194543-3



# Grinding / Sanding

## Inner flange for Angle grinder



For Model	Part No.
AC	224314-5
DC	224483-2
AC	224491-3
DC	224492-1

## Grip, Loop handle

Polisher / Sander / Concrete planer / Random orbit sander / Belt sander



	Models	Thread Size	Without Handguard For polishing	Standard	Rubbierized	Anti vibration
Angle sander	SA4540C, SA5040C	M8	---	153489-2	---	194514-0
	SA7000, SA7000C	M14	---	152539-0	---	194543-3
	PK5001C	M8	---	153489-2	---	---
	PK5011C	M14	---	152539-0	---	---
Disc sander	GV5010, GV6010, GV7000, GV7000C	M10	---	---	---	---
	9218SB	M12	---	152492-0	---	---
Polisher	9237C	M8	---	153489-2	---	---
	9237CB	M8	---	153489-2	---	---
	PV7001C	M10	---	---	---	---
	PV7000C	M10	273649-1	---	---	---
	9218PB, 9218PBL	M12	---	152492-0	---	---
Stone polisher	PW5000C, PW5001C	M8	---	153489-2	---	---
Concrete planer	PC5000C	M8	---	---	---	---
	PC5001C	M8	---	---	---	---
Random orbit sander	BO6040	M8	---	153489-2	---	---
	BO6050	M8	---	---	---	---
Belt sander	9031	M8	---	153489-2	---	---

## Lock nut and Rubber pad for Angle grinder



Angle grinder & Cordless Angle grinder

Wheel Size	Spindle Thread	Rubber Pad			Sanding Lock Nut		Lock Nut Wrench	
		Pad Size (mm)	Max. Rpm	Part No.	Size (mm)	Part No.	Size	Part No.
100mm	M10 x 1.5	76	13,700	743009-6	30	224502-4	20	782401-1 / 782420-7
100mm (9500N)	M10 x 1.25	76	13,700	743009-6	30	224501-6	20	782401-1
115mm	M14 x 2 (DIN)	---	---	---	48	224515-5	28/35	782412-6 / 782407-9 / 782423-1
	5/8"-11 UNC	---	---	---	---	---	28	782412-6
125mm	M14 x 2 (DIN)	115	12,000	743015-1	48	224515-5	28/35	782412-6 / 782407-9 / 782423-1
	5/8"-11 UNC	115	12,000	743015-1	---	---	28	782412-6
150mm	M14 x 2 (DIN)	125	10,950	743016-9	48	224515-5	28/35	782412-6 / 782407-9 / 782423-1
	5/8"-11 UNC	125	10,950	743016-9	---	---	28	782412-6 / 782424-9
180mm - 230mm	M14 x 2 (DIN)	170	8,500	743012-7	48	224515-5	28/35	782412-6 / 782407-9
	5/8"-11 UNC	170	8,500	743012-7	---	---	28	782412-6
	M16	170	8,500	743012-7	48	224523-6	28/35	782412-6 / 782407-9

# Grinding / Sanding

## Lock nut, Rubber pad and Hook & loop Pad for Sanding or Polishing



Models	Spindle Thread	Rubber Pad								Hook & Loop Pad			
		Pad			Sanding Lock Nut		Lock Nut Wrench			Pad type	Pad Size (mm)	Max. Rpm	Part No.
		Pad Size (mm)	Max. Rpm	Part No.	Size (mm)	Part No.	Size	Part No.					
Angle sander with water supply device	PK5011C	M14 x 2 (DIN)	115	12,000	743015-1	48	224515-5	28 / 35	782412-6 / 782407-9	---	---	---	---
		5/8"-11 UNC	115	12,000	743015-1	---	---	28	782412-6	---	---	---	---
	PK5001C	M14 x 2 (DIN)	115	12,000	743015-1	48	224515-5	28 / 35	782412-6 / 782407-9	---	---	---	---
Angle sander / Disc sander / Sander-polisher / Polisher	SA4540C	5/8"-11 UNC	---	---	---	---	---	28	782412-6 / 782424-9	Hook & loop	105	8,000	---
	SA5040C	M14 x 2 (DIN)	115	12,000	743015-1	48	224515-5	28 / 35	782412-6 / 782407-9 / 782424-9 / 782423-1	Hook & loop	115	8,000	743061-4
	SA7000	M14 x 2 (DIN)	170	8,500	743012-7	48	224515-5	28 / 35	782412-6 / 782407-9	---	---	---	---
	SA7000C	M14 x 2 (DIN)	170	8,500	743012-7	---	---	28	782412-6	---	---	---	---
	GV7000	5/8"-11 UNC	170	8,500	743012-7	---	---	28	782412-6	---	---	---	---
	GV7000C	5/8"-11 UNC	170	8,500	743012-7	---	---	28	782412-6	---	---	---	---
	9218SB	M16	170	8,500	743012-7	48	224523-6	28 / 35	782412-6 / 782407-9	---	---	---	---
	9207SPB	M16	170	8,500	743012-7	48	224523-6	28 / 35	782412-6 / 782407-9	---	---	---	---
	9218PB	M16	170	8,500	743012-7	48	224523-6	28 / 35	782412-6 / 782407-9	---	---	---	---
	9218PBL	M16	170	8,500	743012-7	48	224523-6	28 / 35	782412-6 / 782407-9	---	---	---	---
Angle sander / Disc sander / Sander-polisher	9237C	M14 x 2 (DIN)	170	8,500	743012-7	48	224515-5	28 / 35	782412-6 / 782407-9	Hook & loop	165	4,000	743053-3
	9237CB	5/8"-11 UNC	170	8,500	743012-7	---	---	28	782412-6	Hook & loop	165	4,000	---
	PV7001C	5/8"-11 UNC	170	8,500	743012-7	---	---	28	782412-6	Hook & loop	165	4,000	743054-1
	PV7000C	M16	170	8,500	743012-7	48	224523-6	28 / 35	782412-6 / 782407-9	Hook & loop	165	4,000	743054-1
Stone polisher	PW5000C	M14 x 2 (DIN)	---	---	---	---	---	---	---	Hook & loop	96	6,000	743080-0
	PW5001C	M14 x 2 (DIN)	---	---	---	---	---	---	---	Hook & loop	96	6,000	743080-0

## Plastic pad for Disc sander GV6010 and GV5010



Models		Plastic Pad							
		Pad			Clamp screw		Countersunk washer		
		Pad Size (mm)	Max. Rpm	Part No.	Size	Part No.	Size (mm)	Part No.	
Disc sander	GV5010	120	5,000	743025-8	M8x20	265812-0	35	253951-8	
	GV6010	120	5,000	743025-8	M8x20	265812-0	35	253951-8	

## Sanding pad for Twist-on/twist-off system



Models	Rubber pad				
	Pad type	Thread size	Pad Size (mm)	Max. Rpm	Part No.
DPV300, PV301D	For Twist-on/ Twist-off system	1/4"-20 UNC	50	16,000	743124-6

# Grinding / Sanding

## Sanding pad for Twist-on/twist-off system

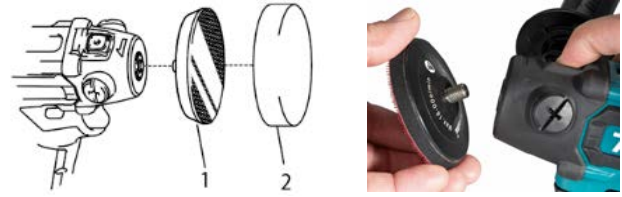

Models	1. Hook & Loop Pad					2. Polishing Pad		
	Pad Type	Thread Size	Pad Size (mm)	Max. Rpm	Part No.	Pad Type	Size (mm)	Part No.
DPV300, PV301D	Hook & loop	5/8"-24 UNF	75	16,000	743125-4	Sponge pad for applying wax Color : White	80	191N91-7
						Sponge pad for polishing Color : Yellow	80	191N90-9
						Wool pad (For high gloss polishing)	80	191N92-5

## Lock nut wrench, Lock nut release socket

Lock nut wrench



Type	For Model	Size	Part No.
Lock nut wrench	All 100mm	20	782401-1
	All 100mm	20	782420-7
	115 / 125mm	35	782423-1
	DIN & Old type	28	782412-6
	180 / 230mm	35	782407-9
	180 / 230mm	35	782034-2

## Extension Handle, Holder, Belt set for DSL800 & DSL801

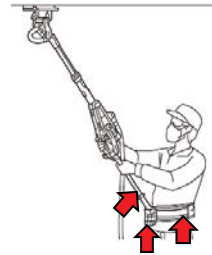

Description	Part No.
Extension Handle, Holder & Belt 3pcs set	199937-7

## Dust cover set / Dust collect cover / Protector

Model/ Item	Description	Part No.
PK5001C	Repair brush short	743333-7
	Repair brush long	743332-9
PK5011C	Repair brush short	743333-7
	Repair brush long	743332-9

## Tool Bag for DSL800 & DSL801

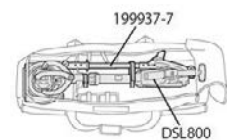
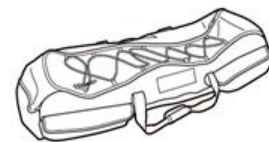

Part No.  
195638-5

## Repair brush for Drywall sander or Concrete planer or Dust collect cover

Model No.	Description	Item no.	Part No.
125mm(5")	For models PC5000C & PC5001C	1+2	194921-7
		1	443144-7
		2	443145-5
125mm (5") set	For model PC5010C For dust collect cover 125mm(5") set P/N:195236-5, 195237-3, 191W06-8, 195239-9, 196575-6, 195774-7, 195775-5, 196587-9 and 191F81-2	1	743332-9
		2	743333-7

## Lock nut for Concrete planer

Models	Spindle Thread	Arbor Size (mm)	Inner Flange		Lock Nut Wrench	
			Size	Part No.	Size	Part No.
PC5000C PC5001C	M14 x 2 (DIN)	22.23	---	---	35	782407-9
	5/8"-11 UNC	22.23	---	---	28	782412-6
PC5010C	M14 x 2 (DIN)	22.23	42	224415-9	35	782407-9
	5/8"-11 UNC	22.23	45	224399-1	28	782412-6

# Grinding / Sanding

## Dust cover attachment set



Model No.	Qty.	Part No.
DPV300, PV301D	1pc (2pcs will be used)	422613-1
DGA404, DGA406, DGA408, DGA411, DGA413, DGA414, DGA417, DGA518, DGA419, DGA454, DGA458, DGA461, DGA462, DGA463, DGA464, DGA467, DGA468, DGA469, DGA504, DGA505, DGA506, DGA508, DGA511, DGA512, DGA513, DGA514, DGA517, DGA518, DGA519, DSC251	Dust cover L	455449-3
	Dust cover R	455450-8
DGA700, DGA701, DGA900, DGA901	-	457620-5
GA003G, GA004G, GA005G, GA006G, GA007G, GA008G, GA011G, GA012G, GA013G, GA014G, GA015G, GA016G, GA035G, GA036G	1pc (2pcs will be used)	422563-0
GA021G, GA022G, GA023G, GA024G, GA025G, GA026G, GA027G, GA028G, GA029G, GA030G, GA031G	-	422610-7
GA4050, GA4050R, GA4051R, GA4550, GA4550R, GA4551R, GA4552, GA4552R, GA4553R, GA5050, GA5050R, GA5051R, GA5052, GA5052R, GA5053R	3pcs.set	199514-5

## Sleeve 18

(For centering pads)

For Model:

9237C/CB, 9227C/B, PV7001/C, PV7000C, SA7000C

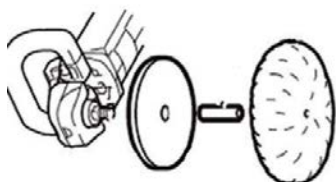

Part No.

262542-4

## Hook & loop pad

Use with pre-punched abrasive disc.



Model No.	Size	Type			Part No.
DSL800, DSL801	210mm	Medium	gray	hook & loop pad (1+2 set)	199939-3
	210mm	Hard	gray	hook & loop pad (1+2 set)	199940-8
	220mm	Soft	black	hook & loop pad (1+2 set)	199938-5



# Grinding / Sanding

## Head cover



Model No.	Part No.
9564CVL, 9565CVL, 9565CLR, PW5000C, PW5001C, PK5001C	417322-5

## Collet cone, Collet nut and Wrench size

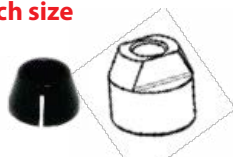

Model No.	Size	Collet Cone	Collet Nut	Wrench Size
		Part No.	Part No.	

### DC models

DGD800, DGD801	3mm	763669-8	763668-0	13mm 19mm
	6mm	763670-3		

### AC models

906, 906H	3mm	763627-4	763240-8	10mm 17mm
	6mm	763620-8		
	1/8"	763626-6		
	1/4"	763625-8		
GD0600, GD0601	3mm	763627-4	763664-8	13mm x2
	6mm	763620-8		
	1/8"	763626-6		
	1/4"	763625-8		
GD0603	3mm	763627-4	763236-9	10mm x2
	6mm	763620-8		
	1/8"	763626-6		
	1/4"	763625-8		
DGD800, DGD801, GD0602	3mm	763669-8	763668-0	13mm x2
	6mm	763670-3		
	8mm	763671-1		
	1/8"	763672-9		
	1/4"	763673-7		
GD0800, GD0800C, GD0810C, GD0801C, GD0811C	3mm	763647-8	763645-2	13mm 19mm
	6mm	763646-0		
	8mm	763649-4		
	1/8"	763651-7		
	1/4"	763650-9		

### Collet cone & nut set

GD0800, GD0800C, GD0810C, GD0801C, GD0811C	6mm	193012-1	13mm 19mm
	8mm	192988-9	
	1/4"	193143-6	

## Side handle set



Model No.	Part No.
GD0800/C, GD0801C, GD0810C, GD0811C	193141-0

## Belt sander plate



Model No.	Steel Plate	Cork Rubber Plate	Carbon plate
	*Include Cork Rubber Plate	For Use With Carbon Plate or Steel Plate.	
	Part No.	Part No.	
9401, 9402	342328-3	421093-8	423029-3
9403	---	421093-8	424057-1
9404	*151751-9	193202-6	193201-8
9924DB	341705-6	423035-8	423036-6
9910, 9911	344586-7	---	---
9920	---	193200-0	193198-1

## Arm



Model No.	Belt Size	Item	Part No.
DBS180, 9032	6 x 533	Arm 6 Assembly	125157-7
	9 x 533	Arm 9 Assembly	125158-5
	13 x 533	Arm 13 Assembly	125159-3

## Stand set



Model No.	Belt Size
DBS180, 9032	193618-5

## Dust collection

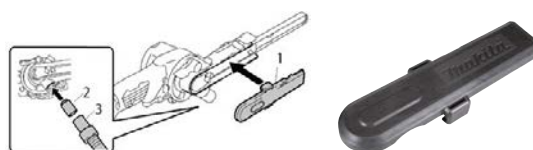

Model No.	Belt Size	Item	Part No.
DBS180, 9032	1	Dust Cover Set	191N60-8
	2	Dust Nozzle Assembly	122652-8

# Grinding / Sanding

## Punch plate

For conventional type of abrasive paper without pre-punched holes

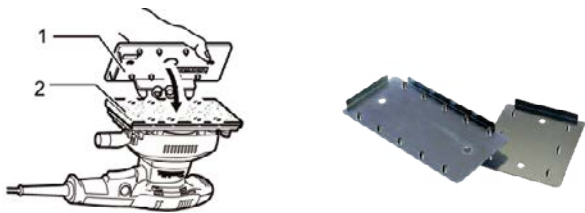

1. Punch plate
2. Abrasive paper without pre-punched holes

Model No.	Material	Part No.
BO4555, BO4556, BO4557, BO4558	PLASTIC	450066-4

## Pad complete



Model No.	Description	Part No.
DBO480, DBO481, DBO482, DBO484	For use with Abrasive paper or clamping type paper	191Y25-6



## Dust box assembly, Paper dust bag and Filter set Dust Bag



Model No.	Part No.
9046	152456-4
BO3710, BO3711	140115-2

## Dust box assembly and Paper dust bag

\*w/o mark of origin



Model No.	Item	Part No.
DBO140, DBO180, BO4555, BO4556, BO4557, BO4558, BO4565, BO4566, BO5030, BO5031, BO5040, BO5041	Dust box assembly (with paper dust bag 1pc)	135246-0
	Paper dust bag (5pcs/set)	194746-9

# Sawing

## Ring

(For 5/8" = 15.88 mm spindle)  
\*With milled edge.



Outer Dia. (mm)	Hole Dia. (mm)	Thickness (mm)	Per pkg.	Part No.
25	15.88	4	1	257022-3

## Holder

(For 5/8" = 15.88 mm spindle)  
\*With milled edge.

Model No.	Item	Part No.
DLS110, DLS111, DLS112, LS1019/L		1 326978-2
		3 961015-1
DLS600, LS1030N, LH1040/F		1 x2 192621-3
		1 322312-4
		2 265708-5
DLS713, DLS714, LS0714/F/FL/L		1 322312-4
		2 251887-5
LS0815FL		1 JM23000127
LS1219, LS1219L		1 327095-1
		3 961015-1
LS1221		2 251887-5

## Vertical vise assembly & Horizontal vise assembly

Vertical vise assembly



Horizontal vise assembly



Model No.	Part No.
Vertical vise assembly	
DLS110, DLS111, DLS112, LS1019, LS1019L, LS1219, LS1219L	126617-2
LS1017L, LS1018L, LH1201FL	JM23100502
LS1040, LS1040F, LH1040, LH1040F	122536-0
Horizontal vise assembly	
DLS110, DLS111, DLS112, LS1019, LS1019L, LS1219, LS1219L, LS1221, LH1201FL	122470-4
DLS713, DLS714, LS0714, LS0714F, LS0714FL, LS0714L	122567-9
LS1017L, LS1018L	122930-6
LS1030N, LS1040, LS1040F, LS1045, LS1440, LH1040, LH1040F	122563-7



# Sawing

## Guide rule

(Rip fence)



Model No.	Part No.
DCS550, DCS551, DCS553, DHS630, DHS660, DHS661, DHS680, DHS710, DHS711, DHS782, DHS783, DSS500, DSS501, DSS610, DSS611, 4191D, 5093D, 5094D, HS300D, 5005BA, 5007F, 5007FA, 5007MG, 5007MGA, 5007N, 5007NB, 5007NF, 5008MG, 5008MGA, 5606B, 5704R, 5740NB, 5800NB, 5806B, HS6100, HS6101, HS6600, HS6601, HS7000, HS7010, HS7010, HS7100, HS7101, HS7600, HS7601, HS7610, HS7611	164095-8
DSP600, DSP601, SP6000	165447-6
HS0600, N5900B, 5902B,	164367-1
5103N, 5201N, 5201NA, 5402, 5402NA, 5430A, 5431A	164019-4

## Rip fence assembly



Model No.	Part No.
LH1201FL	JM23300008

## Angle rule assembly (Miter gauge)

\*Sliding guide



Model No.	Part No.
2703	122555-6
2712	JM27110005

## Belt sanding attachment set

Use a sanding belt that is 2,240 mm long and 20 mm wide or less.



Model No.	Part No.
LB1200F	JM21000330

## Stand: A



Model No.	Part No.
MLT100, MLT100N, 2702, 2703	JM27000300

## Stand: B



Model No.	Part No.
All Slide Compound saw, Miter saw and Table Top Miter Saw	WST07
All Slide Compound saw, Miter saw and Table Top Miter Saw	WST06

## Guide rail



Overall length (m)	Part No.
1.0	199140-0
1.4	194368-5
1.9	194925-9
3	194367-7

Repair Parts Guide Rail	Part No.
Seat 10m set (For upper plastic tape repair)	194416-0
Rubber Seat 10m set (For lower rubber tape repair)	194417-8
Splinter guard seat 1.9m	194910-2
Splinter guard seat 3.0m	194419-4

## Guide rail Joint connector 2pcs set

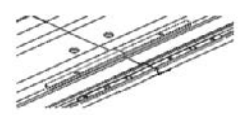

Part No.
198885-7 (EU)



# Sawing

## Clamp set

(Use with Guide rail)



Type	Part No.
A: Standard	194385-5
B: Quick	199826-6



## Blade clamp assembly

(For use of 6.35mm universal shank blades)



Model No.	Part No.
4300BA, 4300BV	132276-260

## Bevel guide set

Adjustable angle of Guide Rail

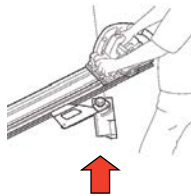

Part No.
196664-7

## Dust nozzle

(Vacuum head)

Please see Suction system chart.



Model No.	Part No.
DJV180, 4350T/CT/FCT, 4351T/CT/FCT	417853-4
DJV181, DJV182	126331-0

## Dust cover & Dust nozzle

Dust cover



Dust nozzle



Model No.	Item	Part No.
JV102D, JV103D	Dust nozzle	457801-1

## Circular guide assembly



Model No.	Part No.
4300BA, 4300BV, 4301SB	123030-5

## Guide Rail Adaptor

Items	A	B	C	D	E	F (D)	G	H	I
	Circular saw					Jig saw		Router Trimmer	Cutter
Models	HS7601 HS7610 HS7611	DHS680	HS6600 HS6601	DHS630 HS6100 HS6101 HS7100 HS7101	DHS660 DHS661	DJV141 DJV142 DJV180 DJV181 DJV182 JV001G JV002G	4350CT 4350FCT 4350FT 4350T 4351CT 4351FCT 4351T	**RT001G **DRT50 **RT0700C **RT0702C 3612BR RP0900 RP0910 RP1110C RP1111C RP1800 RP1800F RP1801 RP1801F RP1802 RP1802F RP1803 RP1803F RP2300FC RP2301FC RP2302FC RP2303FC	DCC500 DCC501 4100KB, 4100NH2
Part No.	197005-0	196953-0	197462-2	197252-3	199232-5	197252-3	193517-1	194579-2	198673-2

\* Use with Plunge base assembly (P/N:195563-0 EU:196094-2)

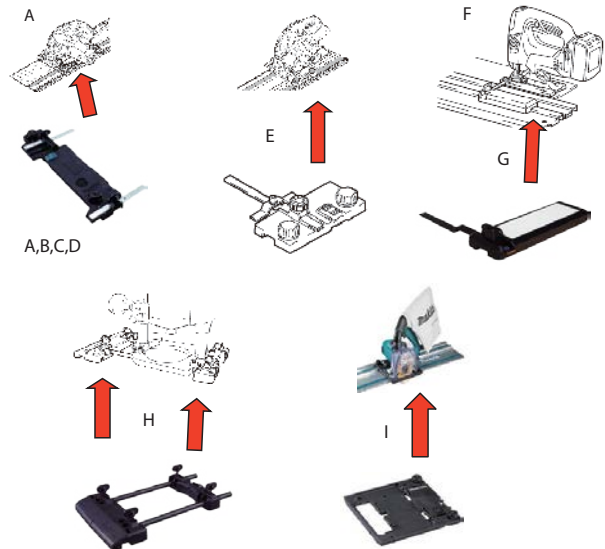

## Guide rule set

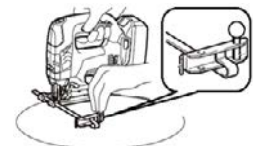

Model No.	Part No.
DJV180, DJV181, DJV182, 4350T/CT/FCT, 4351T/CT/FCT	193516-3
JV100D, JV101D, JV102D, JV103D, JV143D, JV183D, 4326/M, 4327/M, 4328, 4329, JV0600	192732-4

## Rip fence

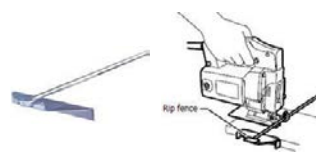

Model No.	Part No.
4300BA, 4300BV	164113-2

# Planing / Routing

## Blade gauge assembly

\*With Poly bag & header



Model No.	Part No.
DKP180, DKP181, KP0800, KP0810/C, N1900B, N1923B, 1002BA, 1100, 1902, 1911B, 1912B	*191C19-9 123062-2 122695-0
1804N, 1805N	123009-6

## Socket wrench 9



Model No.	Part No.
DKP180, DKP181, KP312, KP0800, KP0810/C, N1900B, N1923B, 1002BA, 1100, 1804N, 1805N, 1806B, 1902, 1911B, 1912B	782209-3
2012NB	782203-5

## Set plate

\*2 per pkg.



Model No.	Part No.
DKP180, DKP181, KP0800, KP0810/C, N1900B, N1923B, 1100, 1902	*193540-6

## Sharpening holder assembly & Dressing stone

Sharpening holder assembly



Model No.	Part No.
DKP180, DKP181, KP0800, KP0810/C, N1900B, N1923B, 1100, 1902	191C17-3 123004-6
1804N, 1805N, 1806B	123006-2
1002BA, 1911B, 1912B	123055-9

## Dressing stone

For HSS planer blade

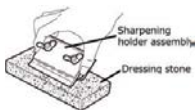

Size(mm)	Grit	Part No.
150	WA1200	794061-7
150	GC1200	D-17756
180	WA1200	794060-9

## Edge fence (Guide rule)

\*with screw



Model No.	Part No.
1100	161046-2
1804N, 1805N	191454-3
N1900B, N1923B, 1911B	191455-1
DKP181	191C23-8

## Chamfering rule assembly

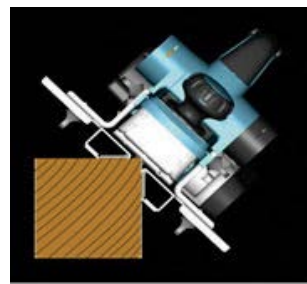

Model No.	Part No.
DKP181	191C22-0

## Depth guide



Model No.	Part No.
DKP181, KP0810/C, N1923B	342390-8

## Hood set

Outer dia. 76 mm

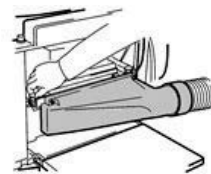

Model No.	Part No.
2012NB	193036-7

## Magnetic holder

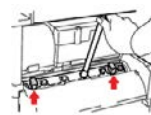

Model No.	Part No.
2012NB	762014-4

# Planing / Routing

## Trimmer guide assembly

\* Use with Plunge base assembly

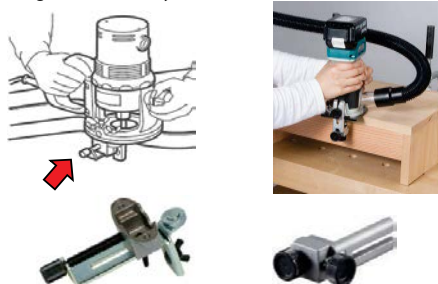

Model No.	Part No.
3707/F/FC, 3708/F/FC, 3709, 3710, N3701, RT0700C	122703-7
3612BR, RP1800/F, RP1801/F, RP2300FC, RP2301FC	123022-4

## Straight guide assembly

(Straight guide)

A: Straight guide with micro adjustment



\* Use with Plunge base assembly (P/N:195563-0 EU:196094-2)

Model No.	Type	Material	Part No.
3709, 3710	-	-	122704-5
3600H, 3601B	-	-	123029-0
3612BR, RP1800/F, RP1801/F, RP2300FC, RP2301FC	-	-	342428-9
RP0900, RP0910, RP1110C, *RT0700C	-	-	164834-6
3612BR, RP0900, RP0910, RP1110C, RF1100, RF1101, RD1100, RD110, RP1100, RP1101, RP1800/F, RP1801/F, RP2300FC, RP2301FC, *RT0700C	A	Steel	193312-9
*DRT50, RP1800/F, RP181/F, RP2300FC, RP2301FC, RP0900, RP0910, RP1110C, *RT0700C	A	Alumi w/o mark of origin	195136-9

## Guide holder assembly



Model No.	Part No.
3612BR	122256-6
RP1800/F, RP1801/F, RP2300FC, RP2301FC	122700-3

## Angle guide for plate joiner



Model No.	Part No.
DPJ180, PJ7000	123149-0

## Biscuit for plate joiner (100 pcs. in set)

- Premium quality
- Select cut size
- High strength
- Finely ground edges
- Compressed beachwood



Model No.	Type	L x W( mm)	Part No.
DPJ180, PJ7000	#0	47 x 15	A-16922
	#10	53 x 19.5	A-16938
	#20	60 x 23.5	A-16944

## Lock nut wrench for plate joiner



Model No.	Part No.
DPJ180, PJ7000	782401-1



# Planing / Routing

## Circular guide set

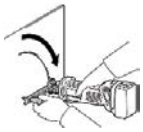

Model No.	Part No.
3706	193448-4

## Collet cone & Collet nut

\*With Poly bag & header



Model No.	Wrench Size	Collet Cone		Collet nut
		Size	Part No.	Part No.
DCO180, DCO181	17mm	3mm	763679-5	763258-9
		6mm	763678-7	



Model No.	Wrench Size	Collet Cone		Collet Nut
		Size	Part No.	Part No.
3706	17mm	6mm	763607-0	763606-2

## Collet cone & Collet nut

Trimmer



Model No.	Wrench Size	Collet Cone		Collet Nut
		Size	Part No.	Part No.
3700B, 3701, 3703, 3707/F/FC, 3708/F/FC, 3709*, 3710*	10mm 17mm	6mm	763607-0	763606-2
		1/4"	763608-8	
3703, 3709, 3710	10mm 17mm	1/4"	763663-0	763661-4
DRT50, RT0700C	13mm 22mm	6mm	763636-3	-
		8mm	763618-5	
		1/4"	763637-1	
		3/8"	763619-3	

## Collet sleeve



Model No.	Collet Size	Bit Size	Part No.
RP1800, RP1800F RP1801, RP1801F RP230FC, RP231FC 3600H, 3601B 3612, 3612BR 3612C	1/2"	1/4"	763803-0
	1/2"	3/8"	763805-6
	1/2"	10mm	763806-4
	12mm	6mm	763801-4
	12mm	8mm	763804-8
	12mm	10mm	763807-2
	12mm	1/4"	763808-0

Router



\*with header & poly bag

Model No.	Wrench Size	Collet Cone		Collet Nut
		Size	Part No.	Part No.
3600H, 3612, 3612BR, 3612C	13mm 24mm	12mm	763628-2	763629-0
		1/2"	763622-4	
RP0900	13mm 22mm	6mm	763636-3	-
		8mm	763618-5	
		1/4"	763637-1	
		3/8"	763619-3	
RP1800, P1800F, RP1801, P1801F, RP230FC, RP231FC	24mm	12mm	763628-2	-
		1/2"	763622-4	



Model No.	Wrench Size	Collet Cone		Collet Nut
		Size	Part No.	Part No.
4403	10mm 17mm	1/4"	763663-0	763661-4

## Templet guide (Metric size)

\*for fast production of complicated shapes by using templet  
\*\*DRT50, RT0700C : Use with Plunge base assembly



Model No.	Type	A (mm)	B (mm)	C (mm)	Part No.
DRT50, 3707/F/FC, 3708/F/FC, 3709, 3710, N3701, RT0700C,		8	10	9.5	*343577-5
DRT50**, 3612BR, RP0900, RP1800/F, RP1801/F, RP230FC, RP2301FC, RT0700C**		7.7	9.5	11.5	164379-4
		9	11	13	164775-6
	14.5	16	13	344364-5	
	18	20	13	164393-0	
	24	27	13	164470-8	
	25	29	15	163080-8	
27	30	13	164471-6		

# Planing / Routing

Templet guide (Metric size)

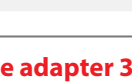
Model No.	Type	A (mm)	B (mm)	C (mm)	Part No.
3600H, 3601B		10.9	12.7	8	323449-0
		14	16	8	323018-7
		14	16	14.5	321308-2

## Templet guide adapter 30

(For B & D, Porter-Cable two-piece templet guide)

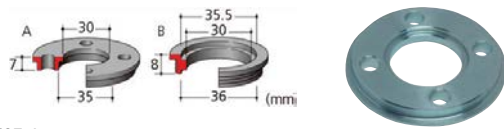

Nut M30  
Part No. 252627-4

Templet guide adapter 30  
Type A or TypeB

Templet guide 25  
Part No. 321812-1

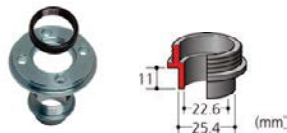

Plunge base assembly (P/N:195563-0 (EU:196094-2)) is also necessary.

Model No.	Type	Part No.
DRT50**, 3612BR, RP0900, RP1800/F, RP1801/F, RP2300FC, RP2301FC, RT0700C**	A	321492-3

## Trimmer base assembly







Transparent base



Model No.	Bit Size	Part No.
3700B, N3701, 3703, 3704, 4403	-	122202-9
	A: Transparent base	122238-8
3709, 3710	A: Transparent base	194267-1

## Base for DRT50 & RT0700C

Able to meet a wide range of needs with the Motor unit and the following various attachments

Item	Per Pkg.	Part No.
Trimmer base assembly 	1	196613-4
Trimmer base plate 	1	196924-7
Trimmer base assembly clear 	1	199090-9
Plunge base assembly Optional Fine adjusting straight guide can be used 	1	195563-0
Plunge base plate 	1	450819-1
Tilt base assembly Tilting capacity: -30° to 45° 	1	198987-9
Offset base assembly 	1	EU:195562-2













Able to trim close to wall and tight corners with a bit set in offset position. Distance 18.5mm from the edge to the center of bit

# Others

## Heat gun accessories

For Model: HG6031V, HG6030, HG5030, HG6530V, HG6531C







Shape		Part No.
Glass protection nozzle		PR0000028
Wide-slot nozzle		PR0000029
Reflector nozzle		PR0000030
Reduction nozzle 20		PR0000031
Overlap welding nozzle		PR0000032
Solder sleeves reflector		PR0000033
Welding nozzle		PR0000034
Pressure roller		PR0000035
Welding rods	ABS	PR0000036
	HDPE	PR0000037
	PP	PR0000038
Speed welding nozzle		PR0000039
Scraper		PR0000040
Scraper set		PR0000041
Scraper		PR0000042



## Rechargeable Green Multi Line Laser accessories

For Model

\*Thread size: W5/8

Shape		Part No.
Tripod 1800 *Thread size: W5/8		TK0LM4001F
For model: SK312GD, SK209GD, SK700D/GD, SK106D/GD, SK105D/GD		
Mount		LE00870137
For model: SK700D/GD, SK106D/GD, SK105D/GD		
Laser Receiver LDX1		LE00855702
For model: SK700D/GD, SK106D/GD, SK105D/GD		
Laser Receiver LDG-3		TK0LDG301F
For model: SK312GD, SK209GD		
Laser Receiver LDG-5		TK0LDG501F
For model: SK40GD, SK20GD, SK10GD, SK312GD, SK209GD		

# Carbon Brush

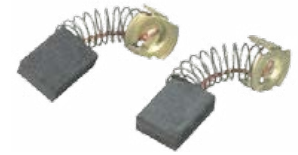

Carbon Brush	Part Number	Model								
CB-1	181019-9	903								
CB-51A	B-80232	1902	3700B	4300BV	6013BR	6016	6300NB			
CB-55	181026-2	8416	JR3000V							
CB-55A	B-80248									
CB-64	194968-1	6412	6413	6510LVR	9035	906	BO3710	BO4540	DP4700	GD0603
CB-64A	B-80254	GV6010	JV0600K							
CB-65	191628-6	6905B	906H	JS1600	JS1670					
CB-65A	B-80260									
CB-70	191914-5	6501								
CB-70A	B-80276									
CB-85	194973-8	HP1630								
CB-85A	B-80282									
CB-100A	B-80298	1100	6906	9045B	9215SB	9218SB	9924DB	JN3200	JS3200	PC1100
CB-106	194976-2	1911B	3620	RP0900	UT1301					
CB-106A	B-80313									
CB-132	191972-1	UC3520A	UC4020A	UC3541A	UC4041A					
CB-153	181044-0	1804N	1805N	2012NB	2416S	3501N	3600H	3601B	3612BR	4107R
CB-153A	B-80329	5008B	5008MG	5016B	5103N	5201N	5401N	5402	6910	9105
		9401	HS0600	LF1000	LS1013	LS1016	LS1019L	LS1040	LS1212	LS1214
		LS1216	LS1219L	LS1440	N5900B	TW1000	UC3530A	UC3531A	UC4030A	UC4051A
CB-173	195483-8	VC2510L	VC3210L							
CB-203	194991-6	2414NB	3612C	HW1200	HW1300	LC1230	LW1400	LW1400	RP1801	
CB-203A	B-80341									
CB-253	194547-5	PC5000C								
CB-303	194996-6	2107F	4100NH	4100NH3Z	4131	5606B	5740NB	5806B	9015B	9016B
CB-303A	B-80379	9227C	9237C	CA5000	DA4000LR	GA5010	GA5020	GA6010	HS7010	HS7600
		JN3201J	JR3050T	JR3060T	JR3070CT	JS3201J	LS0714	PV7000C	UB1100	UB1101
		UB1102	UT1305	UT1305	UT2204					
CB-325	194074-2	9553NB	9556NBG	9556PBG	9556HBG	9556HP	9557NBG	9563H	GA4040	GD0600
		GD0601	GD0602	HR2230	HR2300	HR2310T	HR2320T	HR2460	HR2470	HR2600
		HR2601	HR2610	HR2611FT	HR2630	HR2631FT	HR2800	HR2810		
CB-411	191940-4	3709	3901	4403	6922NB	9031	9500NB	9523NB	DS4011	JN1601
CB-411A	B-80391	KP0800	RT0700C	TD0101F	TW0200	TW0350				
CB-415	191950-1	6904VH								
CB-415A	B-80400									
CB-419	191962-4	4304	4350CT	9035H	BO4510H	BO4556	BO5031	DA3010F	FS2300	FS2500
CB-419A	B-80422	FS2700	FS4300	HP1620	HP2030	HP2050	HP2070	HR1830	HR2020	HR2440
		JS1300	TD0100	UH4570X	UH5570X	UH6570X	UH7580X			
CB-459	194722-3	GA4030	GA4031	GA4034	GA54530	GA4534	GA5030	GA5034	HR1840	HR1841
		JS1000	JS1601	JS1602	PJ7000	TM3000C	TM3010C			
	3641000	HW111								
	3641160	HW102								
	375009-001	SJ401								
	EIB106C	HB500								
	JM23000123	LH1201FL	LS1018L	MLT100						

## Auto Cut - Out Carbon Brush

CB-105	181038-5	HM0810A	HM0810TA	HR2010	HR3520					
CB-105A	B-80307									
CB-155	181048-2	HM1201								
CB-155A	B-80335									
CB-204	191957-7	4112HS	4114S	9617	GA7010C	GA7012C	GA7020	GA7030	GA7040R	GA7040S
CB204A	B-80357	GA9010C	GA9012C	GA9030	GA9030R	GA9040S	GA9050	GS5000	HM1302	HM1305
		HM1306	HM1810	SA7000C						
CB-218	197129-2	GA7060	GA7060R	GA7061R	GA7062	GA7063R	GA9060	HM1812		
CB-318	191978-9	9563C	GA4040C	GA4041C	GD0800C	PK5001C	PO6000C	PW5001C	SG1250	SG1251J
CB-327	195003-8	HM0860C								
CB-350	194160-9	HK1820	HM0870C	HM0871C	HR3200C	HR4001C	HR4002	HR4003C	HR4003C	HR4030C

## Carbon Brush for Cordless Tools

CB-430	191971-3	8414D	DCS550	DCO180	BGA450	DGA402	DGA452	DGD800	BHR240	DJN161
CB-438		DJS101	DJS161	DJV180	DPB180	DPJ180	DSS501	BUB360	DUC122	DHR165
		DUB361								
CB-434	193466-2	6932FD	6935FD	BTW121						
CB-440	195021-6	DDA351	DDF442	DDF444	BDF450	BDF452	DDF456	DDF458	DDF482	DFR550
		DFS450	DFS451	BHP442	DHP444	DHP444	BHP450	BHP452	BHP454	DHP456
		DHP458	DHP482	DJS130	BTD142	BTD146	DTP140	DTW152	DTW251	DBN500
		TD091D								
CB-441	195022-4	DHR202	DHR241	DHS630	DJR181	DJR182	DJR186	DKP180	DLS713	DSS610
		DTW450								
CB-442	194928-3	BHR261	BHR262	BUC250	BUH550	BUH650	DHR263	DHS710	DUC252	DUC302
		DUH651								
CB-448	196855-0	DTW152	DTW251							





# Strap Belt System

## System as a STRAP

Totally new on the market - unique STRAP Belt System with quick release buckles at the ends makes the belt multipurpose. STRAP with comfortable soft rubber soulder pad makes the lifting more comfortable. Fits to all Makita Tool bags and Cases.



## System as a BELT

Strap BELT can be easily detached from any Tool Bag or Tool Case and worn on the waist as a light-duty tool belt. Strap can be adjusted, which is flexible and convenient to fit your need. Can be worn with any Makita Tool Pouch and Holder.



**Over 45 products within the system**

**E-05418**  
Ultimate Adjustable Tool Case

**E-05416**  
Ultimate Covered Tool Tote

**E-05424**  
Reinforced Adjustable Tool Case

**E-05430**  
Ultimate Open Tool Tote

**E-05474**  
Ultimate 3-Way Universal Tool Tote

**E-05480**  
Ultimate 4-Sided Tool Tote

**E-05549**  
Ultimate Chainsaw Bag

**E-05561**  
Roll-Top All Weather Tube Bag

**E-05468**  
Ultimate Wide Mouth Tool Bag

**E-05577**  
Roll-Top All Weather Duffel Bag

**E-05452**  
Ultimate Gate Mouth Tool Bag

**E-11782**  
Ultimate Heavyweight Tool Bag

**E-05670**  
1M Guide Rail Protective Holder

**E-05664**  
1.4M / 1.5M Guide Rail Protective Holder

**E-10920**  
1.9M Guide Rail Protective Holder

**E-10936**  
3M Guide Rail Protective Holder

**E-05505**  
Technician Tool & Laptop Bag

**E-05496**  
Semi-Rigid Tool Bag

**E-05620**  
Ultimate Lunch Bag & Belt

**E-05583**  
Ultimate Smartphone Holder

**E-12980**  
Ultimate Smartphone Holder XL

**E-05309**  
Belt Loop - 3 Pack

**E-05315**  
Belt Loop - 6 Pack

**E-05278**  
Tape Measure Holder

**E-05212**  
Ultimate 4-Way Electricians Holder

**E-05228**  
Ultimate 3-Way Hammer & Tool Holder

**E-05262**  
Knife / Secateur Holder

**E-05234**  
Side Gate Hammer & Tool Holder

**E-05256**  
Universal Clip Holder

**E-05240**  
Looped Hammer & Axe Holder

**E-05599**  
Thermal Flask & Holder

**E-05608**  
Thermal Mug & Holder

**E-05103**  
Pencil Driver Holster Universal L/R Handed

**E-05153**  
Roofer & General Purpose Pouch

**E-05147**  
Ultimate 3 Pocket Fixing Pouch

**E-05181**  
Ultimate Electricians Pouch

**E-05131**  
Ultimate 2 Pocket Fixing Pouch

**E-05094**  
Drill Holster Universal L/R Handed

**E-05206**  
Zip Top Pouch - Dual Battery or Fixings

**E-05284**  
Ultimate Chisel & Tool Holder

**E-05197**  
Fixing Pouch & Hammer Holder

**E-05212**  
Ultimate 4-Way Electricians Holder

**E-05278**  
Tape Measure Holder

**E-05262**  
Knife / Secateur Holder

**E-05228**  
Ultimate 3-Way Hammer & Tool Holder

**E-05256**  
Universal Clip Holder

**E-05240**  
Looped Hammer & Axe Holder

**E-05599**  
Thermal Flask & Holder

**E-05608**  
Thermal Mug & Holder

**E-05103**  
Pencil Driver Holster Universal L/R Handed

**E-05153**  
Roofer & General Purpose Pouch

**E-05147**  
Ultimate 3 Pocket Fixing Pouch

**E-05181**  
Ultimate Electricians Pouch

**E-05131**  
Ultimate 2 Pocket Fixing Pouch

**E-05094**  
Drill Holster Universal L/R Handed

**E-05206**  
Zip Top Pouch - Dual Battery or Fixings

**E-05284**  
Ultimate Chisel & Tool Holder

**E-05197**  
Fixing Pouch & Hammer Holder

**E-05119**  
Impact Driver Holster Universal L/R Handed

**E-05125**  
Universal Pouch & Drill Holster L/R Handed

# Tool Holders 3rd Generation Technical Solutions



**Strap Belt System** with quick release buckles at the ends can be easily detached from the Tool Bags and worn on the waist as a light-duty tool belt. Fits all Tool Pouches and Holders as well as Tool Organizers.



**3 LAYERS**

**3L Technology** is a unique 3-layer combination of polyesters and foam that provides extra cushioning. Designed to be tough and weatherproof, these amazingly light polypropylene panels are made up of three composite layers joined securely in a desirable configuration. The innovative feature of these structured core panels means that they can be formed into any shape.



**WATERPROOF BOTTOM**

**Waterproof Bottom** is a high quality solution for tool bags – rigid, wear-resistant and waterproof it keeps tools dry and protected from damp and wet surfaces. The reinforced plastic base also helps you to keep your tool bag clean.



**Real Leather** is smooth on the outside with brushed suede on the inside. Strong and tough for a long life but soft and supple enough for lasting comfort, whilst providing excellent strength with added abrasion resistance. Heavy gauge leather has been selected for use in products requiring a thicker covering - 1.8 to 2.0mm - ensuring a top quality product.



**Durable Riveting** gives truly unbreakable strength. Strong one piece self-punching rivets with washers used in all high stress areas. Washers for greater strength in strategical places are used on one or both sides, up and down.



**ANTI SLIP**

**Anti-Slip Solution** minimises or even avoids workplace slip and fall accidents. The high quality polypropylene tape has a rubbery surface which helps to keep you tools in place and provides additional protection to help prolong the life of your products.



**Elastic Loops** secures the contents and keeps your tools in place while carrying. It provides great flexibility for organizing your tools and accessories. Elastic Loops have been applied to a wide variety of our products to ensure that you get maximum usage from your kit. The loops are able to adapt to perfectly suit all tools and accessories.



**Side-Gate Solution** lets you easily put the tool in without looking at the holder. An additional swing feature ensures your tool is kept at a comfortable angle. Made of stainless steel for product longevity and fixed by four rivets for extra strength.



# Blue Collection

## E-05664 - 1.4M - 1.5M Guide Rail Protective Holder

STRAP/BELT SYSTEM 3 LAYERS

	metric
height:	220 mm
length:	1565 mm
width:	45 mm
weight:	1.45 kg



## E-05125 - Universal Pouch & Drill Holster LR Handed

REAL LEATHER 3D SHAPED POUCHES DURABLE RIVETING  
STRAP/BELT SYSTEM ANTI SLIP 3 LAYERS ELASTIC LOOPS

	metric
height:	270 mm
length:	260 mm
width:	145 mm
weight:	0.55 kg



DESIGNED FOR PROFESSIONAL USE



## E-05511 - Backpack Tool Organiser

WATERPROOF BOTTOM CB BACKPACK CARRYING SYSTEM TOOL LOOPS SYSTEM  
ELASTIC LOOPS

	metric
height:	490 mm
length:	390 mm
width:	230 mm
weight:	2.56 kg



## E-05094 - Drill Holster Universal LR Handed

REAL LEATHER 3D SHAPED POUCHES DURABLE RIVETING  
STRAP/BELT SYSTEM ANTI SLIP 3 LAYERS ELASTIC LOOPS

	metric
height:	235 mm
length:	155 mm
width:	75 mm
weight:	0.13 kg



## E-05446 - Ultimate Covered Tool Tote

STRAP/BELT SYSTEM WATERPROOF BOTTOM DURABLE RIVETING ELASTIC LOOPS

	metric
height:	360 mm
length:	490 mm
width:	310 mm
weight:	2.72 kg



KEEPING YOUR TOOLS WELL PROTECTED

\*Limited quantity

\*Tools and accessories not inclusive

# Blue Collection

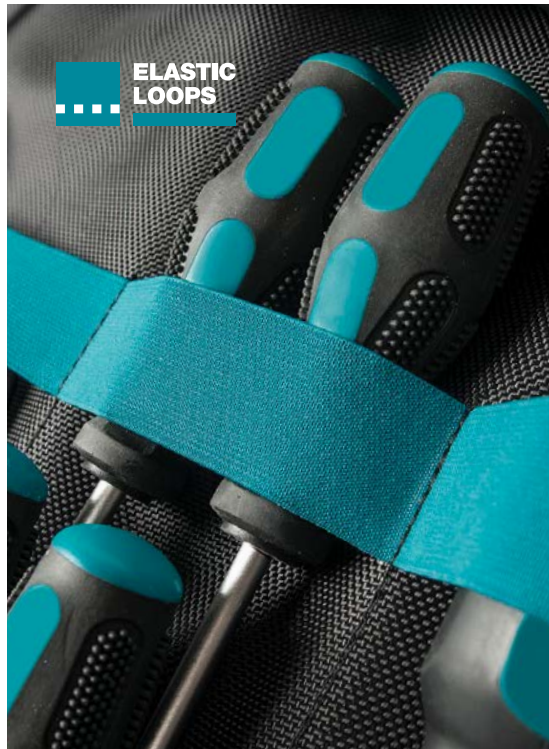

**E-05583 - Ultimate Smartphone Holder**

STRAP/BELT SYSTEM 3 LAYERS LOOP-CLIP SOLUTION ELASTIC LOOPS

	metric
height:	165 mm
length:	90 mm
width:	40 mm
weight:	0.12 kg



**E-12980 - Ultimate Smartphone Holder XL**

STRAP/BELT SYSTEM 3 LAYERS LOOP-CLIP SOLUTION ELASTIC LOOPS

	metric
height:	200 mm
length:	115 mm
width:	40 mm
weight:	0.15 kg



**E-05212 - Ultimate 4-Way Electricians Holder**

STRAP/BELT SYSTEM REAL LEATHER DURABLE RIVETING ELASTIC LOOPS

	metric
height:	205 mm
length:	185 mm
width:	55 mm
weight:	0.28 kg



**E-05103 - Pencil Driver Holster Universal LR Handed**

STRAP/BELT SYSTEM ANTI SLIP ELASTIC LOOPS

	metric
height:	320 mm
length:	85 mm
width:	60 mm
weight:	0.11 kg



**E-05658 - Ultimate Knee Pad Set**



	metric
height:	240 mm
length:	170 mm
width:	30 mm
weight:	0.28 kg



**E-05527 - Bucket Tote Tool Organiser**

ELASTIC LOOPS

	metric
height:	320 mm
length:	470 mm
width:	-
weight:	0.68 kg



\* Tools and accessories not inclusive

# Blue Collection



3D SHAPET IN MODERN DESIGN

## E-05153 - Roofer & General Purpose Pouch

- REAL LEATHER
- SIDE-GATE SOLUTION
- 3D SHAPED POUCHES
- DURABLE RIVETING
- STRAP/BELT SYSTEM
- ANTI SLIP
- 3 LAYERS
- ELASTIC LOOPS

	metric
height:	270 mm
length:	290 mm
width:	145 mm
weight:	0.66 kg



## E-05343 - Ultimate Leather Belt with Belt Loop

- REAL LEATHER
- BELT LOOP HOLDER

	metric
height:	48 mm
length:	1380 mm
width:	-
weight:	0.30 kg



## E-05175 - Ultimate Heavyweight Tool Belt Set

- BELT LOOP HOLDER
- 3D SHAPED POUCHES
- DURABLE RIVETING
- REAL LEATHER
- STRAP/BELT SYSTEM
- ANTI SLIP
- 3 LAYERS
- ELASTIC LOOPS

	metric
height:	310 mm
length:	880 mm
width:	-
weight:	1.73 kg



## E-05337 - Quick Release Belt & Belt Loop

- BELT LOOP HOLDER

	metric
height:	50 mm
length:	1550 mm
width:	-
weight:	0.25 kg



POLYETHYLENE STRAP INSIDE

## E-05309 - Belt Loop -3pcs

- STRAP/BELT SYSTEM

	metric
height:	129 mm
length:	41 mm
width:	-
weight:	0.03 kg



## P-80896 - Smart Phone Holder\*

- Universal size fits most most smart phones
- Soft internal lining to protect you phones screen
- Fits any MAKITA Tool Belt

	metric
height:	150 mm
length:	100 mm
width:	25 mm
weight:	0.09 kg



## P-80999 - Pencil Driver Holster\*

- Designed to hold cordless power tool models
- Hook-and-loop security strap ensures safe climbing ladders and scaffolding

	metric
height:	320 mm
length:	80 mm
width:	50 mm
weight:	0.12 kg



## P-71722 - Drill Holster and Pouch\*

- Unique design complete interchangeability between left and right users
- Fits cordless or main-powered drill

	metric
height:	280 mm
length:	255 mm
width:	160 mm
weight:	0.58 kg



\* Tools and accessories not inclusive

# Combination / Rotary Hammer Drill Capability Chart

		EPTA Weight (kg)																Material for drilling				Drilling/ chiselling ratio			
		0	10	20	30	40	50	60	70	80	90	100	110	120	130	140	150	160	Highly reinforced concrete	Concrete, granite, stone, brick	Metal/ wood		Working direction		
16mm series	HR166D	3.2-16 3.2-10	[Color-coded bars]																Diamond core 32 (dry type)	✓	✓✓✓	✓	↕		
	SDS-plus																								
17mm series	DHR171	3.2-17 3.2-10	[Color-coded bars]																Diamond core 32 (dry type)	✓	✓✓✓	✓	↕		
	SDS-plus																								
18mm series	HR1840/41F	3.2-18 3.2-10	[Color-coded bars]																Diamond core 32 ~ 65 (dry type)	✓	✓✓✓	✓	↕		
	SDS-plus																								
	DHR182	2.4~3.2	3.2-18 3.2-10	[Color-coded bars]																Diamond core 32 (dry type)	✓	✓✓✓	✓	↕	
20mm series	DHR202	3.2-20 4-12	[Color-coded bars]																Diamond core 32 (dry type)	✓	✓✓✓	✓	↕		
	SDS-plus																								
22mm series	DHR2230	3.2-22 4-14	[Color-coded bars]																Diamond core 32 ~ 65 (dry type)	✓	✓✓✓	✓	↕		
	SDS-plus																								
	MT870	2.5	3.2-22 4-14	[Color-coded bars]																Diamond core 32 ~ 65 (dry type)	✓	✓✓✓	✓	↕	
23mm series	DHR2300	3.2-23 4-15	[Color-coded bars]																Diamond core 32 ~ 70 (dry type)	✓	✓✓✓	✓	↕		
	SDS-plus																								
	HR2310T	2.9	3.2-23 4-15	[Color-coded bars]																Diamond core 32 ~ 70 (dry type)	✓	✓✓✓	✓	↕	
	SDS-plus																								
24mm series	HR2320T	3.2-23 4-15	[Color-coded bars]																Diamond core 32 ~ 70 (dry type)	✓	✓✓✓	✓	↕		
	SDS-plus																								
	HR2460	3.2-24 4-16	[Color-coded bars]																Diamond core 32 ~ 65 (dry type)	✓	✓✓✓	✓	↕		
	SDS-plus																								
	HR2470	2.9	3.2-24 4-16	[Color-coded bars]																Diamond core 32 ~ 65 (dry type)	✓	✓✓✓	✓	↕	
SDS-plus																									
26mm series	DHR241	3.2-20 4-12	[Color-coded bars]																Diamond core 32 (dry type)	✓	✓✓✓	✓	↕		
	SDS-plus																								
	DHR242	3.2-24 4-16	[Color-coded bars]																Diamond core 32 ~ 65 (dry type)	✓	✓✓✓	✓	↕		
	SDS-plus																								
	DHR263	3.5	3.2-26 4-18	[Color-coded bars]																Diamond core 32 ~ 65 (dry type)	✓	✓✓✓	✓	↕	
28mm series	HR2600 Series	3.2-26 4-18	[Color-coded bars]																Diamond core 32 ~ 80 (dry type)	✓	✓✓✓	✓	↕		
	SDS-plus																								
	HR2630 Series	3.2-26 4-18	[Color-coded bars]																Diamond core 32 ~ 80 (dry type)	✓	✓✓✓	✓	↕		
	SDS-plus																								
	HR2650 Series	3.2-26 4-18	[Color-coded bars]																Diamond core 32 ~ 80 (dry type)	✓	✓✓✓	✓	↕		
	SDS-plus																								
	HR2661	3.2	3.2-26 4-18	[Color-coded bars]																Diamond core 32 ~ 80 (dry type)	✓	✓✓✓	✓	↕	
SDS-plus																									
M8701	2.7	3.2-26 4-18	[Color-coded bars]																Diamond core 32 ~ 80 (dry type)	✓	✓✓✓	✓	↕		
30mm series	HR2800 Series	3.2-28 6-20	[Color-coded bars]																Diamond core 32 ~ 80 (dry type)	✓	✓✓✓	✓	↕		
	SDS-plus																								
	DHR282 Series	3.9~5.0	3.2-28 6-20	[Color-coded bars]																Diamond core 32 ~ 65 (dry type)	✓	✓✓✓	✓	↕	
30mm series	HR001G Series	3.2-28 6-20	[Color-coded bars]																Diamond core 32 ~ 65 (dry type)	✓	✓✓✓	✓	↕		
	SDS-plus																								
40mm series	HR3210FCT Series	4-32 10-22	[Color-coded bars]																Diamond core 32 ~ 90 (dry type)	✓✓✓	✓✓✓	✓	↕		
	SDS-plus																								
	HR4002	6.6	[Color-coded bars]																10-40 16-32 20-105	✓✓✓	✓✓✓		↕		
	SDS-max																								
HR4013C Series	6.2~6.8	[Color-coded bars]																10-40 16-35 20-105	✓✓✓	✓✓✓		↕			
SDS-max																									
45mm series	DHR400	7.3~8.1	[Color-coded bars]																10-40 16-35 20-105	✓✓✓	✓✓✓		↕		
	SDS-max																								
	HR005G	7.4~7.9	10-40 16-35 20-105	[Color-coded bars]																✓✓✓	✓✓✓		↕		
50mm series	HR4511C Series	8.2~9.0	[Color-coded bars]																10-45 22-40 20-125	✓✓✓	✓✓✓		↕		
	SDS-max																								
50mm series	HR5212C Series	10.9~11.9	[Color-coded bars]																19-52 25-45 20-160	✓✓✓	✓✓✓		↕		
	SDS-max																								
50mm series	HR006G Series	12.9~14.3	[Color-coded bars]																19-52 25-45 20-160	✓✓✓	✓✓✓		↕		
	SDS-max																								

approx: 50% drilling, 50% chiselling

- Tungsten Carbide-tipped usable range
- Recommended range
- Core bits

- ✓✓✓ Optimal
- ✓ Possible

# Safety Precautions

When using electric tools, basic safety precautions should always be followed to reduce the risk of fire, electric shock, and personal injury, including the following.

## /// KEEP WORK AREA CLEAN.

Cluttered areas and benches invite injuries.

## /// CONSIDER WORK AREA ENVIRONMENT.

Don't use power tools in damp or wet locations. Keep work area well lit. Don't expose power tools to rain. Don't use power tool in presence of flammable liquids or gases.

## /// KEEP CHILDREN AWAY.

All visitors should be kept away from work area. Don't let visitors touch the tool or extension cord.

## /// STORE IDLE TOOLS.

When not in use, tools should be stored in a dry, high of locked up place, out of reach of children.

## /// DON'T FORCE THE TOOL.

It will do the job better and safer at the rate for which it was intended.

## /// USE THE RIGHT TOOL.

Don't force small tools or attachments to do the job of a heavy-duty tool. Don't use tools for purposes not intended.

## /// DRESS PROPERLY.

Don't wear loose clothing or jewelry. They can be caught in moving parts. Rubber gloves and non-skid footwear are recommended when working outdoors. Wear protective hair covering to contain long hair.

## /// USE SAFETY GLASSES.

Also use face or dust mask if the cutting operation is dusty.

## /// DON'T ABUSE THE CORD.

Never carry the tool by the cord or yank it to disconnect it from the socket. Keep the cord away from heat, oil, and sharp edges.

## /// SECURE WORK.

Use clamps or a vise to hold the work. It's safer than using your hand and it frees both hands to operate the tool.

## /// DON'T OVERREACH.

Keep proper footing and balance at all times.

## /// MAINTAIN TOOLS WITH CARE.

Keep cutting tools sharp and clean for better and safer performance. Follow instructions for lubrication and changing accessories. Inspect tool cord periodically and if damaged, have it repaired by an authorized service facility. Inspect extension cords periodically and replace, if damaged. Keep handles dry, clean and free from oil and grease.

## /// DISCONNECT TOOLS.

When not in use, before servicing and when changing accessories such as blades, bits and cutters.

## /// REMOVE ADJUSTING KEYS AND WRENCHES.

Form the habit of checking to see that keys and adjusting wrenches are removed from the tool before turning it on.

## /// AVOID UNINTENTIONAL STARTING.

Don't carry a plugged-in tool with a finger on the switch. Ensure switch is OFF when plugging in.

## /// USE OUTDOOR EXTENSION CORDS.

When tool is used outdoors, use only extension cords intended for outdoor use.

## /// STAY ALERT.

Watch what you are doing. Use common sense. Don't operate tool when you are tired.

## /// CHECK DAMAGED PARTS.

Before further use of the tool, a guard or other part that is damaged should be carefully checked to determine that it will operate properly and perform its intended function. Check for alignment of moving parts, free running of moving parts, breakage of parts, mounting and any other conditions that may affect its operation. A guard or other part that is damaged should be properly repaired or replaced by an authorized service center unless otherwise indicated in this instruction manual. Have defective switches replaced by an authorized service facility. Don't use the tool if the switch does not turn it on and off.

## /// GUARD AGAINST ELECTRIC SHOCK.

Avoid body contact with earthed or grounded surfaces (e.g. pipes, radiators, ranges, refrigerators).

## /// REPLACEMENT PARTS.

When servicing a tool, use only identical replacement parts.

## /// VOLTAGE WARNING:

Before connecting the tool to a power source (receptacle, outlet, etc.) Be sure the voltage supplied is the same as that specified on the nameplate of the tool. A power source with voltage greater than that specified for the tool can result in SERIOUS INJURY to the user V as well as damage to the tool. If in doubt, DO NOT PLUG IN THE TOOL. Using a power source with voltage less than the nameplate rating is harmful to the motor.

## Note

- Makita reserves the right to change specifications of parts and accessories without notice.
- Items of standard equipment and specifications may vary by country or area.
- Net weight and dimensions may differ by the type of battery.
- Standard export color for motor housing is Makita industrial green (blue).
- Please state required voltage when ordering. These offers are subject to availability in each country. Actual product color may differ slightly from color reproduced here.
- Weight data in this catalogue is the value measured by us according to EPTA Procedure 01/ 2003.

## Warranty

Every **MAKITA** tool is thoroughly inspected and tested before leaving the factory. Subject to the following Terms and Conditions from the date of purchase, this tool is **warranty against defective materials and manufacturing defects for a period of 6 MONTHS for AC and non brushless DC tools. As for brushless DC tools it will be a period of 12 MONTHS. Same goes to Makita charger warranty, against defective materials and manufacturing defects for a period of 12 MONTHS. As for Makita Light will be a period of 6 MONTHS.**

### The period and conditions of our warranty as follows:

1. Sales receipt must be presented when servicing or warranty is required.
2. Warranty ONLY cover tools distributed by Makita Singapore Pte. Ltd. Warranty does not cover tools purchased overseas or distributed by other countries.
3. This warranty is valid base on the original purchase receipt with "Date of Purchase", "Model Number" & "Serial Number".

### This warranty will be null & void in any of the following events during the warranty period:

1. The product unit has undergone repair, attempted repair, dismantle or modification in any way whatsoever by any other person.
2. Damage resulting from use of improper accessories, non-genuine replacement parts, disassembly, tampering, alternation and repairing in any way that affects the reliability and performance.
3. Damage resulting from negligence, accident, disaster, improper storage or maintenance, abuse and misuse in evident caused by overloading the tool beyond its capacity.
4. Abnormal voltage or usage of generator, wrong usage not in accordance with the Operation Manual.
5. If the Serial Number on the tool, seal on the battery and charger has been defaced or removed.
6. If any information on the warranty card has been defaced, removed, altered, unreadable or unclear (date of purchase, Serial Number, etc.)

\*\* Makita reserved the rights of amend conditions of warranty without prior notice.

Please visit our website for Makita's Service Centre information

<http://www.makita.com.sg/servicing-the-customer>



[www.makita.com.sg](http://www.makita.com.sg)

**TRADEMARKS**



Makita Corporation and its affiliates (collectively referred to as "Makita") are the registered owners of the above trademarks and own the exclusive rights to these trademarks. A party who manufactures, advertises, offers for sale, sells, distributes, imports or exports power tools, batteries and/or related accessories using a trademark which is identical or similar to our trademarks may have infringed our trademarks. Makita take a serious view of trademark infringement and will not hesitate to take any legal action against any party who infringes our trademark rights.

**Makita Singapore Pte Ltd**

7, Changi South Street 3, Singapore 486348  
Phone : +65-6546-8700 Fax : +65-6546-8711  
Email : [msgproductteam@makita.com.sg](mailto:msgproductteam@makita.com.sg)  
Website : [www.makita.com.sg](http://www.makita.com.sg)  
Facebook : [www.facebook.com/MakitaSG](http://www.facebook.com/MakitaSG)



PRINTED IN SINGAPORE