

**Makita**®



**2024/25**  
**GENERAL CATALOGUE**



# PRODUCT CATEGORY

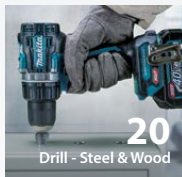

20 Drill - Steel & Wood

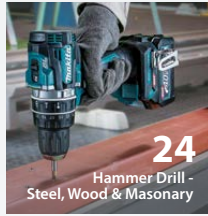

24 Hammer Drill - Steel, Wood & Masonry



26 Impact Driver



29 Impact Wrench

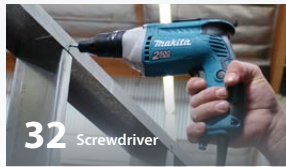

32 Screwdriver



Mixer 33

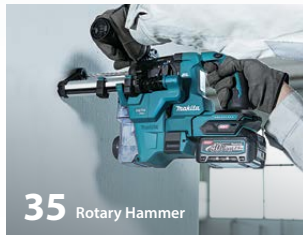

35 Rotary Hammer

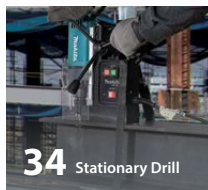

34 Stationary Drill



41 Demolition Hammer

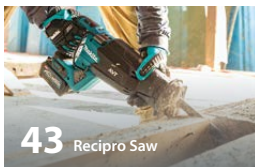

43 Recipro Saw

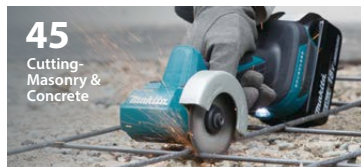

45 Cutting-Masonry & Concrete



47 Metal Cutting



Grinder 51



Sawing 63



65 Circular Saw



Jig Saw 69



71 Planing & Routing



78 Dust Extraction

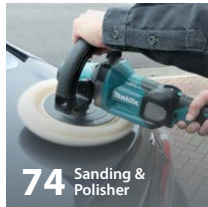

74 Sanding & Polisher



Power Cutter 88



88 Pressure Washer



90 Heat Gun

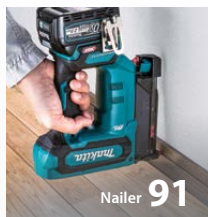

Nailer 91



93 Speciality Tools



97 Comfort/Lifestyle



96 Measuring/Leveling



107 OPE Tools



101 Lights



124 Cordless Tools For Industry



129 MT Series



Index	
<b>1</b>	
1805N	71
1911B	71
<b>2</b>	
2012NB	72
2107FK	48
2416S	50
2712	65
<b>3</b>	
3601B	73
3711	73
<b>4</b>	
4100KB	46
4100NH	46
4100NH3Z	46
4100NH3Z/B	46
4107R	46
4112HS	46
4114S	46
4114S/B	46
4131	47
4131/B	47
4327M	70
4403	73
<b>5</b>	
5008MG	69
5103N	69
5806B	68
5806B/B	68
<b>6</b>	
6305	23
6412	23
6412/B	23
6413	23
6906	30
<b>9</b>	
9031	77
9035H	77
906/B	62
9218SB	76
9237C	75
9500NB	56
9556HNG	57
9556HP/BX	57
9556HPG	57
9557HNG	58
9924DB	77
<b>A</b>	
AC001GZ <b>NEW</b>	94
AF301	92
AF506	92
AS001GZ02	80
AT1022AZ	93
<b>B</b>	
BO3710	77
BO4510H	77
BO4556	77
BO5031	75
BO6050J	74
<b>C</b>	
CA5000X	51
CC301DSYE	46
CE001GZ01	88
CE002GZ	88
CF001GZ	98
CF002GZ	97
CF003GZ <b>NEW</b>	97
CG100DZA	95
CL001GD115(RD/T+B)	85
CL001GZ04(Z/T+B)	85
CL001GZ12(Z/T+W)	85

C	
CL002GZ03(ZB)	85
CL002GZ07(ZW)	85
CL003GD114(RDW)	85
CL003GD115(RDB)	85
CL003GZ09(ZB)	85
CL003GZ14(ZW)	85
CL100DW	86
CL106FDSAW / FDZ	86
CLX224SAX1	21
CP100DSA / DZ	95
CS002GZ	47
CW001GZ	99
CW002GZ	98
CW003GZ	99
CW004GZ <b>NEW</b>	98
<b>D</b>	
DA3010F	23
DA333DSAE / DZ	23
DAS180Z	80
DBO180Z	74
DBO380RTJ / Z	76
DBO481RTJ / Z	77
DBS180Z	77
DCC500RTE / Z	45
DCF102ZX1	98
DCF203Z	98
DCF301Z	98
DCG180ZB	95
DCL184Z	84
DCL280FZB	86
DCL283FRFB / FZB	85
DCL284FRFB / FZB	85
DCL286FRFB / FZB	85
DCO181Z	72
DCS552Z	47
DCS553Z	47
DCU180Z	112
DCU601Z <b>NEW</b>	111
DCU602Z <b>NEW</b>	111
DCU603Z	112
DCU604Z	112
DCU605Z	112
DDA351Z	22
DDF083RFE / Z	22
DDF458RTE / RFE	20
DDF482RTE / RFE / Z	20
DDF484RTE / RFE / Z	20
DDF486RTE / RFE / Z	20
DDF487RFJ / Z	21
DDF489RTJ / Z <b>NEW</b>	21
DDG460ZX4	123
DF001DW	22
DF001GM201(RM2J) / GD201(RD2J) / GZ	20
DF002GD201(RD2J) / GA201(SA2J) / GZ	20
DF012DSE	22
DF0300	22
DF032DSAE / DZ	22
DF033DZ	22
DF330DWE	21
DF332DSAE / DZ	21
DF333DSAE / DZ	21
DF488D004 / DYEX4	21
DFL302FZ	127
DFL402FZ	127
DFL650FZ	127
DFN350ZJ	92
DFT025FNZ	125
DFT045FNZ	125
DFT060FNZ	126

D	
DFT060TNZ	126
DFT085FNZ	126
DFT087FNZ	126
DFT120TNZ	126
DFT127FNZ	126
DFT129FNZ	126
DG001GZ02	123
DGA406RTE / RFE / Z	56
DGA408RTJ1 / Z	56
DGA413RTE / Z	56
DGA417RTE	56
DGA417Z	56
DGA419Z	56
DGA469Z	55
DGA506RTE / Z	55
DGA508RTE / Z	55
DGA513RTE / Z	55
DGA517RTE / Z	55
DGD800Z	61
DGP180Z	93
DHG180ZK	90
DHG181ZK	90
DHK180Z	41
DHP453RFX4 / RYE	25
DHP482RTE / RFX1 / RFE / Z	24
DHP484RTE / RFE / Z	24
DHP486RTE / Z	24
DHP487RFJ / Z	25
DHP489RTJ / Z <b>NEW</b>	24
DHR183RTWJ / Z	38
DHR202RTE / Z	38
DHR242RTE / Z	37
DHR400ZKN	37
DHS660Z	67
DHS661RGJ / Z	67
DHS710Z	67
DHS900Z	67
DHW080ZK	88
DJN161Z	51
DJR183RTE / Z	44
DJR186RTE / ZK	44
DJR187RTE / ZK	44
DJR188RTJ / Z	44
DJR189RTJ / Z	44
DJR360Z	43
DJS101Z	50
DJS130Z	50
DJS161Z	50
DJV182RTE / Z	70
DJV184RTJ / Z	70
DKP181Z	71
DLM230Z	120
DLM382CF2 / Z	120
DLM460Z	120
DLM462Z	119
DLM480Z	119
DLM481Z	119
DLM530Z	119
DLM532Z	119
DLM533Z	119
DLM538Z	119
DLM539Z	119
DLW140Z	49
DLX2131JX7	21
DMC300RTJ	45
DMC300Z	45
DML805	101
DML807	105
DML809	101
DML810	104
DML811	101

D	
DML812	104
DML813	102
DML814	102
DML815	104
DML816	105
DML817	105
DMP180Z	96
DMR057	100
DMR108	100
DP4002/B	23
DP4700	23
DPB180Z	48
DPB182Z	48
DPB183Z	48
DPB184Z	48
DPJ180Z	72
DPO600RTE / Z	74
DPP200ZK	49
DPT353RTE / Z	91
DPV300RTJ / Z	75
DRC300Z	83
DRT50Z	72
DRT52Z <b>NEW</b>	73
DRV250Z	93
DS4011	23
DSC163ZK	48
DSC191Z	49
DSC251ZK	47
DSL800Z	74
DSL801Z	74
DSP600Z	66
DSP601Z	66
DSS501RTE / Z	68
DSS610RTE / Z	68
DST1212K	93
DST221Z	93
DST421ZK	93
DTC100ZK <b>NEW</b>	94
DTC101ZK <b>NEW</b>	94
DTD152RTE / RFE / Z	27
DTD153RTE / Z	27
DTD154RTE / Z	27
DTD156SYE / ZK	27
DTD157RTJ / Z	27
DTD172RFJ / RTE / Z	27
DTDA040Z	128
DTDA070Z	128
DTDA140Z	128
DTL061Z	28
DTL063Z	31
DTM51Z	95
DTM52RTJX2 / Z	94
DTR181Z	94
DTS141Z	28
DTW1001JX2 / Z	29
DTW1002JX2 / Z	29
DTW190RFE / Z	30
DTW251RTE / Z	30
DTW300RTJ / RFJ / Z	30
DTW450RTE / Z	30
DTW700RTJ / Z	30
DTW800RMJ	29
DTWA070Z	128
DTWA100Z	129
DTWA140Z	129
DTWA190Z	129
DTWA260Z <b>NEW</b>	129
DUA301ZB	110
DUB184Z	79
DUB185Z	80
DUB186Z	80



<b>D</b>	
DUB187Z	79
DUB362Z	79
DUB363ZV	79
DUC150Z <b>NEW</b>	109
DUC254Z	109
DUC306ZB	109
DUC353ZB	108
DUC355Z	108
DUC357ZX4	109
DUH502Z	113
DUH506Z	113
DUH507F001 / Z	113
DUH601Z	113
DUH604SZ	113
DUH606Z	113
DUH751Z	113
DUH754SZ	112
DUM111SYX	115
DUM604SF / Z	114
DUN461WSF / WZ	114
DUN500WZ	114
DUP361ZN	122
DUR181Z	117
DUR189Z	116
DUR193SF / Z	116
DUR1945FX2	116
DUR368LZ	116
DUR369LZ	116
DUS054Z	122
DUS108Z	122
DUS158Z	122
DUT130Z	33
DUX18Z	108
DUX60Z	107
DVC150LZ	81
DVC155LZX2	81
DVC350Z	86
DVC560PG2 / Z	82
DVC660ZX7	83
DVC665Z	83
DVC750LZX1	84
DVC860LZ	81
DVC865LZX2	82
DVC867LZX4	82
DVF104Z	123
DVF154Z	123
DVP180Z	94
DVP181ZK	94
DWR180RF / Z	31
DWT310ZK	32
<b>E</b>	
ELM3320	121
ELM3720	120
ELM4121	120
ELM4620	120
<b>F</b>	
FN001GD101(RDK) / GZ	92
FS2500	32
FS2700	32
FS4300	32
<b>G</b>	
GA003GM201(RM2J) / GD201(RD2J) / GZ	54
GA004GZ	54
GA005GZ	53
GA011GD201(RD2J) / GZ	54
GA012GZJ / GZ	54
GA013GZJ / GZ	52
GA022GZJ / GZ	54
GA023GZJ / GZ	52
GA027GZJ / GZ	54

<b>G</b>	
GA028GZJ / GZ	53
GA029GZJ / GZ	52
GA035GZ	52
GA036GZ	52
GA037GZ	51
GA038GZ	51
GA042GZJ / GZ	54
GA044GD201(RD2J) / GZ	52
GA048GZ <b>NEW</b>	54
GA050GZ <b>NEW</b>	52
GA051GZ <b>NEW</b>	52
GA4030	57
GA4031	57
GA4034	58
GA4040	57
GA4040C	57
GA4050R	57
GA4100 <b>NEW</b>	57
GA4593X01	58
GA4595	59
GA5010	59
GA5010/B	59
GA5030	59
GA5034	59
GA5050R	59
GA5080R	59
GA5091X01	60
GA5100 <b>NEW</b>	59
GA6010	60
GA6010X3/B	60
GA6020C	60
GA7020	60
GA7060	60
GA7060R/B	60
GA7070X1	60
GA7070X1/B	60
GA7081	60
GA7090 <b>NEW</b>	60
GA9020	61
GA9060	61
GA9070X1	61
GA9081	61
GA9090 <b>NEW</b>	61
GB602	62
GB801	62
GD0600	61
GD0600/B	61
GD0601	61
GD0602	62
GD0603	62
GD0603/B	62
GD0800C	62
GS5000	62
GV6010	76
<b>H</b>	
HB350	34
HB500	34
HB500/B	34
HG5030	90
HG6030K	90
HG6031VK	91
HG6530VK	91
HG6531CK	91
HK1820	41
HM001GZ03(K)	41
HM002GZ03	41
HM0810A	41
HM0810TA	42
HM0810TA/B	42
HM0870C	42
HM0870C/B	42

<b>H</b>	
HM0871C	42
HM1205C	42
HM1213C	42
HM1214C	42
HM1214C/B	42
HM1306	42
HM1306/B	42
HM1501	42
HM1511	43
HM1812	43
HM1812/B	43
HP001GM201(RM2J) / GD201(RD2J) / GZ	24
HP002GD201(RD2J) / GA201(SA2J) / GZ	24
HP0300	25
HP1630	25
HP1630/B	25
HP2050	26
HP2070	26
HP330DWE	25
HP332DSAE / DZ	25
HP333DSAE / DWYE / DYEX4 / DZ	25
HR001GD201(RD2J) / GZ	36
HR002GM201(RM2J) / GZ	36
HR003GM201(RM2J) / GZ	36
HR004GM201(RM2J) / GZ	36
HR005GM201(RM2J) / GZ	35
HR006GZ(K)	35
HR007GM201(RM2J) / GZ	36
HR008GM201(RM2J) / GZ	35
HR009GM201(RM2J) / GZ	35
HR010GD201(RD2J) / GZ <b>NEW</b>	36
HR166DSAE1 / DZ	38
HR1840J	38
HR2020	38
HR2300/B	38
HR2470X5	39
HR2470X5/B	39
HR2630/B	39
HR2630X3	39
HR2810	39
HR2810/B	39
HR3001CJ	39
HR3011FCJ	40
HR3200C	40
HR4002	40
HR4002/B	40
HR4003C	40
HR4003C/B	40
HR4013C	40
HR4501C	40
HR5202C	40
HR5202C/B	40
HR5212C	40
HS003GM201(RM2) / GZ	67
HS004GM201(RM2) / GZ	67
HS009GZ	66
HS010GZ	66
HS012GZ	67
HS0600	69
HS300DW / DZ	68
HS301DWAE / DZ	68
HS6600	68
HS7010	68
HS7600	68
HW001GZ <b>NEW</b>	88
HW102	89
HW1300	89
HW132	89
HW151	89

<b>J</b>	
JN1601	51
JN3201J	51
JR001GM201(RM2J) / GD201(RD2J) / GZ	43
JR002GM201(RM2J) / GD201(RD2J) / GZ	43
JR103DWYE	44
JR3051TK	44
JR3070CT	44
JR3070CT/B	44
JS1300	50
JS1601	50
JS1602	50
JS3201J	50
JV002GM201 / GZ <b>NEW</b>	69
JV0600K	70
JV101DSAE / DZ	70
JV103DSAJ / DZ	70
<b>K</b>	
KP001GZ	71
KP0800X	71
<b>L</b>	
LB1200F	65
LC1230	48
LC1230/B	48
LCT204	21
LD030P	97
LD050P	97
LD080P	97
LH1201FL	64
LM001CZ	119
LM001GZ	118
LM001JM101	117
LM002JM101	117
LM003GZ <b>NEW</b>	118
LM004GZ <b>NEW</b>	118
LM004JZ	117
LS002GZ	63
LS003GZ	63
LS004GZ	63
LS0714	63
LS1018L	63
LS1019L	63
LS1040	64
LS1110F <b>NEW</b>	64
LS1219L	64
LS1440	64
LW1401	49
LW1401/B	49
<b>M</b>	
M0600B	130
M0801B	130
M0801BX1	130
M0900B	131
M0910B	131
M0920B	132
M0921B	132
M1902B	134
M2300B	133
M2401B	131
M3600B	134
M3601B	133
M3700B	133
M4000B	134
M4001B	134
M4100B	131
M4301B	133
M4302B	133
M4500B	133
M5801B	133
M6001B	129



<b>M</b>	
M6500B	129
M6600XB	130
M8100B	130
M8103B	130
M8103KX2B	130
M8600B	131
M8700B	130
M8701B	130
M9002B	132
M9100B	132
M9200B	134
M9203B	134
M9204B	134
M9400B	134
M9506B	131
M9508B	132
M9510B	132
M9512B	131
M9513B	132
ML001G	104
ML002G	104
ML003G	101
ML005GX	101
ML006G	105
ML007G	104
ML009G	101
ML010G	102
ML011G	105
ML106	104
ML107	105
MLT100	65
MP001GZ	95
MP100DZ	96
MR002G	100
MR006G	100
MR010G	100
MW001GZ <b>NEW</b>	99
<b>N</b>	
N3701	73
N5900B	69
<b>P</b>	
PB002GM201(RM2K) / GZ	48
PC5000C/B	76
PC5010C	76
PC5010C/B	76
PDC01 (191A62-6 / 191A67-6)	19
PDC1200A01 / A02	19
PDC1500A01 <b>NEW</b>	19
PJ7000	72
PK5001C	76
PM001GT202(PT2) / GZ01 <b>NEW</b>	123
PO6000C	74
PT001GD201(RD2K) / GZ	91
PT354DZ	92
PV001GM101(RMX) / GZ	75
PV301DSAE	75
PV7000C	75
<b>R</b>	
RP0900	73
RT001GM202(RM2J) / GZ04	72
RT0700C / CX2	73
<b>S</b>	
SG1251J	46
SJ401	65
SK105GDZ	97
SK10GDZ	96
SK40GDZ	96
SK700GD	96
SP001GZ	65
SP6000J	66
ST002GZ <b>NEW</b>	92
<b>T</b>	
TB131	34
TD001GM201(RM2J) / GD201(RD2J) / GZ	26
TD002GZ01	26
TD003GA201 / GZ	27
TD0101F	28
TD022DSE	28
TD043DNZ	128
TD063DNZ	128
TD090DWE	28
TD110DSAE / DWYE / DZ	28
TD111DSAE / DZ	28
TL064DZ	28
TM3010CX6	95
TW001GM204(RM2JX) / GD203(RD2JX) / GZ	29
TW004GD201(RD2J) / GZ	29
TW007GM201(RM2J) / GZ	29
TW0200	30
TW0350	30
TW0350/B	30
TW1000	31
TW1000/B	31
<b>U</b>	
UA001GM102(RM) / GZ01	110
UA002GM102(RM) / GZ01	110
UB001CZ	79
UB001GM201(RMX) / GZ	78
UB002CZ01	79
UB003CZ <b>NEW</b>	78
UB100DZ	80
UB101DZ	80
UB1102	80
UB1103	80
UB1103/B	80
UC003GZ01	108
UC012GT101(RT) / GZ	108
UC014GT101(RT) / GZ	108
UC015GT101(RT) / GZ	108
UC022GZ <b>NEW</b>	108
UC100DZ	109
UC3541A	110
UC3551A	110
UC4041A	110
UC4051A	110
UC4551A	110
UH006GZ	112
UH014GZ	112
UH201DZ	114
UH353DSA / DZ	114
UM600DSYEX / DWA / DZ	115
UN460WDZ	114
UP100DZ <b>NEW</b>	122
UR003GZ	115
UR008GM101(RM) / GZ01	115
UR012GZ04	115
UR013GZ03	115
UR017GZ	116
UR100DWA / DZ	117
UR202CZ	116
UR3000	117
US053DZ	123
UT001GZ	33
UT1301	34
UT1305	34
UT1305/B	34
UV001GZ <b>NEW</b>	121
UX01GZ	107
<b>V</b>	
VC006GMZ03	81
VC008GZ04	82
VC009GZ	82
VC011GZ <b>NEW</b>	82
VC2000L	85
VC2510L	85
VC3210L	84
VC3210L/B	84
VS001GZ <b>NEW</b>	83
<b>W</b>	
WR100DSAEK / DZ	31
WT001GZ <b>NEW</b>	32
<b>V</b>	
VC003GLZ	81
VC004GLZ	81



## Safety Precautions

When using electric tools, basic safety precautions should always be followed to reduce the risk of fire, electric shock, and personal injury, including the following.

### /// KEEP WORK AREA CLEAN.

Cluttered areas and benches invite injuries.

### /// CONSIDER WORK AREA ENVIRONMENT.

Don't use power tools in damp or wet locations. Keep work area well lit. Don't expose power tools to rain. Don't use power tool in presence of flammable liquids or gases.

### /// KEEP CHILDREN AWAY.

All visitors should be kept away from work area. Don't let visitors touch the tool or extension cord.

### /// STORE IDLE TOOLS.

When not in use, tools should be stored in a dry, high of locked up place, out of reach of children.

### /// DON'T FORCE THE TOOL.

It will do the job better and safer at the rate for which it was intended.

### /// USE THE RIGHT TOOL.

Don't force small tools or attachments to do the job of a heavy-duty tool. Don't use tools for purposes not intended.

### /// DRESS PROPERLY.

Don't wear loose clothing or jewelry. They can be caught in moving parts. Rubber gloves and non-skid footwear are recommended when working outdoors. Wear protective hair covering to contain long hair.

### /// USE SAFETY GLASSES.

Also use face or dust mask if the cutting operation is dusty.

### /// DON'T ABUSE THE CORD.

Never carry the tool by the cord or yank it to disconnect it from the socket. Keep the cord away from heat, oil, and sharp edges.

### /// SECURE WORK.

Use clamps or a vise to hold the work. It's safer than using your hand and it frees both hands to operate the tool.

### /// DON'T OVERREACH.

Keep proper footing and balance at all times.

### /// MAINTAIN TOOLS WITH CARE.

Keep cutting tools sharp and clean for better and safer performance. Follow instructions for lubrication and changing accessories. Inspect tool cord periodically and if damaged, have it repaired by an authorized service facility. Inspect extension cords periodically and replace, if damaged. Keep handles dry, clean and free from oil and grease.

### /// DISCONNECT TOOLS.

When not in use, before servicing and when changing accessories such as blades, bits and cutters.

### /// REMOVE ADJUSTING KEYS AND WRENCHES.

Form the habit of checking to see that keys and adjusting wrenches are removed from the tool before turning it on.

### /// AVOID UNINTENTIONAL STARTING.

Don't carry a plugged-in tool with a finger on the switch. Ensure switch is OFF when plugging in.

### /// USE OUTDOOR EXTENSION CORDS.

When tool is used outdoors, use only extension cords intended for outdoor use.

### /// STAY ALERT.

Watch what you are doing. Use common sense. Don't operate tool when you are tired.

### /// CHECK DAMAGED PARTS.

Before further use of the tool, a guard or other part that is damaged should be carefully checked to determine that it will operate properly and perform its intended function. Check for alignment of moving parts, free running of moving parts, breakage of parts, mounting and any other conditions that may affect its operation. A guard or other part that is damaged should be properly repaired or replaced by an authorized service center unless otherwise indicated in this instruction manual. Have defective switches replaced by an authorized service facility. Don't use the tool if the switch does not turn it on and off.

### /// GUARD AGAINST ELECTRIC SHOCK.

Avoid body contact with earthed or grounded surfaces (e.g. pipes, radiators, ranges, refrigerators).

### /// REPLACEMENT PARTS.

When servicing a tool, use only identical replacement parts.

### /// VOLTAGE WARNING:

Before connecting the tool to a power source (receptacle, outlet, etc.) Be sure the voltage supplied is the same as that specified on the nameplate of the tool. A power source with voltage greater than that specified for the tool can result in SERIOUS INJURY to the user V as well as damage to the tool. If in doubt, DO NOT PLUG IN THE TOOL. Using a power source with voltage less than the nameplate rating is harmful to the motor.

## Note

- Makita reserves the right to change specifications of parts and accessories without notice.
- Items of standard equipment and specifications may vary by country or area.
- Net weight and dimensions may differ by the type of battery.
- Standard export color for motor housing is Makita industrial green (blue).
- Please state required voltage when ordering. These offers are subject to availability in each country. Actual product color may differ slightly from color reproduced here.
- Weight data in this catalogue is the value measured by us according to EPTA Procedure 01/2003.

## Warranty

Every **MAKITA** tool is thoroughly inspected and tested before leaving the factory. Subject to the following Terms and Conditions from the date of purchase, this tool is **warranty against defective materials and manufacturing defects for a period of 6 MONTHS for AC and non brushless DC tools. As for brushless DC tools it will be a period of 12 MONTHS. Same goes to Makita charger warranty, against defective materials and manufacturing defects for a period of 12 MONTHS. As for Makita Light will be a period of 6 MONTHS.**

### The period and conditions of our warranty as follows:

1. Sales receipt must be presented when servicing or warranty is required.
2. Warranty ONLY cover tools distributed by Makita Singapore Pte. Ltd. Warranty does not cover tools purchased overseas or distributed by other countries.
3. **This warranty is valid base on the original purchase receipt with "Date of Purchase", "Model Number" & "Serial Number".**

### This warranty will be null & void in any of the following events during the warranty period:

1. The product unit has undergone repair, attempted repair, dismantle or modification in any way whatsoever by any other person.
2. Damage resulting from use of improper accessories, non-genuine replacement parts, disassembly, tampering, alternation and repairing in any way that affects the reliability and performance.
3. Damage resulting from negligence, accident, disaster, improper storage or maintenance, abuse and misuse in evident caused by overloading the tool beyond its capacity.
4. Abnormal voltage or usage of generator, wrong usage not in accordance with the Operation Manual.
5. If the Serial Number on the tool, seal on the battery and charger has been defaced or removed.
6. If any information on the warranty card has been defaced, removed, altered, unreadable or unclear (date of purchase, Serial Number, etc.)

\*\* Makita reserved the rights of amend conditions of warranty without prior notice.

Please visit our website for Makita's Service Centre information

<http://www.makita.com.sg/servicing-the-customer>

**Tool ◀▶ Battery ◀▶ Battery Charger**  
**Digital communication**

**XGT is a new system with its own tools, batteries, and chargers. A combination of innovative tool design and higher output batteries provide a genuine solution for high demand industrial users.**

**Optimum power supply system and Optimum charging system**

The XGT range of tools and batteries come with a built-in program, providing digital communication between the battery and tool. Allowing not only for the battery to talk with tool but also the tool to talk to the battery. Battery technology and motor engineering that work together for optimum performance.



**Optimum charging system**

Auto maintenance system with two cooling fans for providing more optimum fast charging

**Built Tough**

High durability specifications specially designed for 40Vmax Li-Ion batteries

4-LED fuel gauge indicator

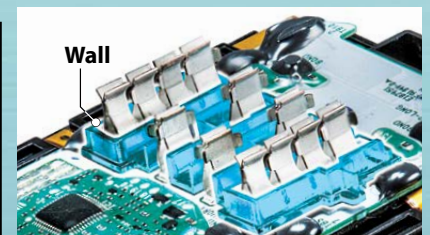
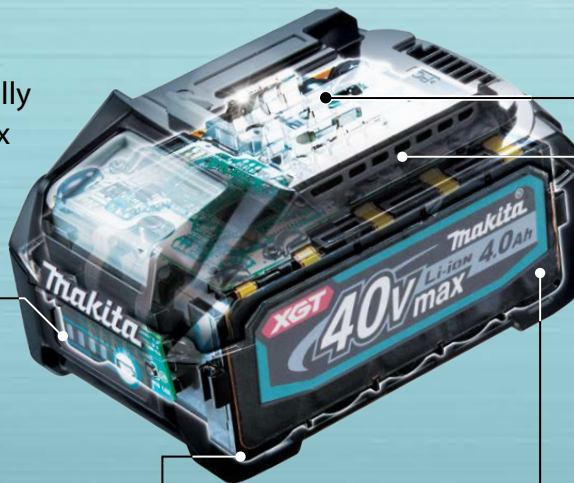

**Terminal short-circuit prevention structure**  
The protection wall is provided between terminals against water and dust.

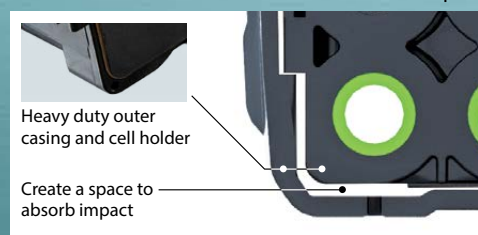

Heavy duty outer casing and cell holder  
Create a space to absorb impact

**Shock absorption structure**

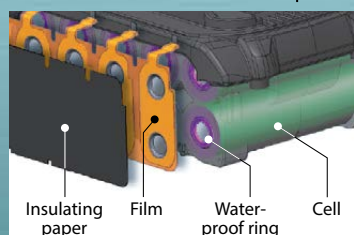

Insulating paper Film Water-proof ring Cell  
**Waterproof Triple-layer Structure**  
prevents cell failure due to water and dust.

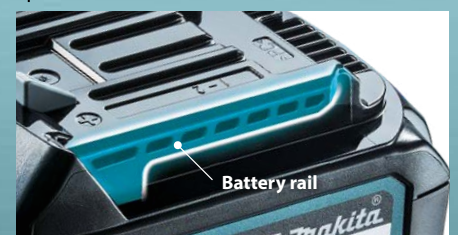

**High Rigidity Battery Rails**  
Durable slide in battery rail that holds the battery and the tools firmly and securely to withstand high power products



## 40Vmax mechanism movie

This movie was filmed in Japan.  
Models and specs may vary by country.



## Rapid Optimum Charging System

It is necessary to cool down before start charging when the battery temperature is high.  
Built-in fan circulates air through the battery before start charging and during the charging process to cool the battery for faster charge time.

The Makita Rapid Optimum Charger communicates with the battery's built-in chip throughout the charging process to optimize battery life by actively controlling current, voltage and temperature.

The optimum charging system  
Forced air cooling

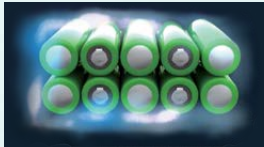

Fast charging



General charging method  
Natural heat dissipation

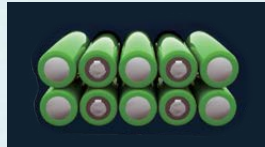

Waiting time for charging

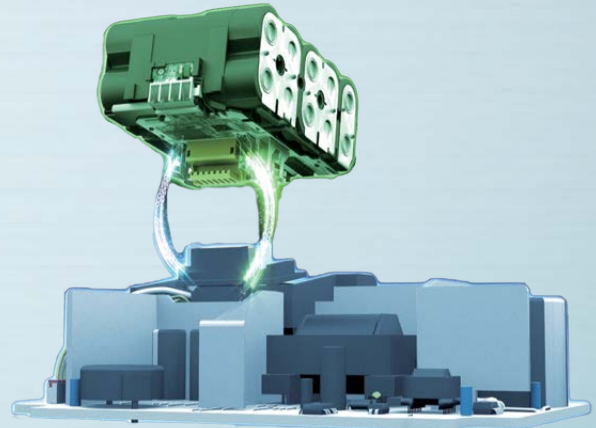

The optimum charging system

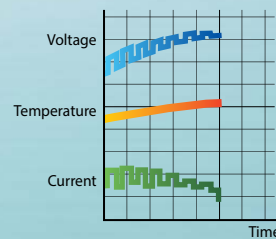

General charging method

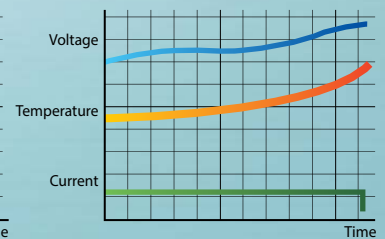

## Battery Protection Function

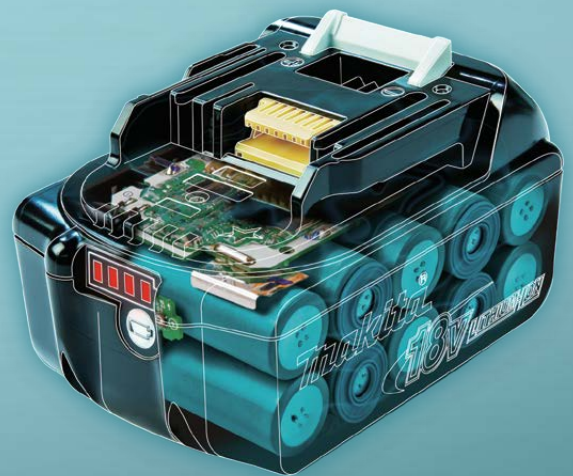
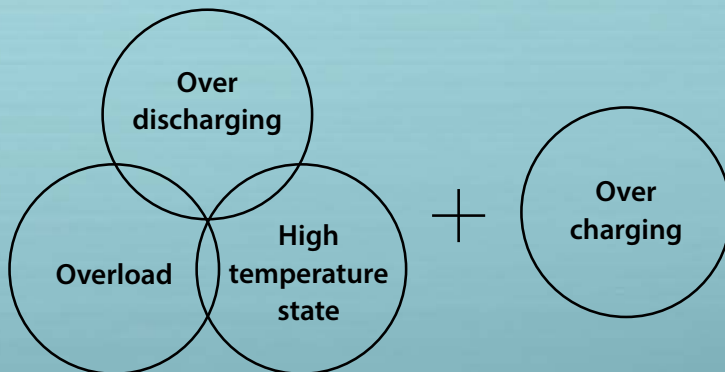

This function is communication technology that allows the tool and battery to monitor conditions and exchange data in real time to protect against Overload, Over-Discharge and Overheating.

## Firm Holding

Multi-contact terminals reduce electrical resistance and increase connection stability withstanding against vibration, and ultimately ensures Stable current supply to the tool.

**Anytime Charge**  
No Memory Effect  
No discharging required



**Shock Absorbing**  
Heavy Duty Pack

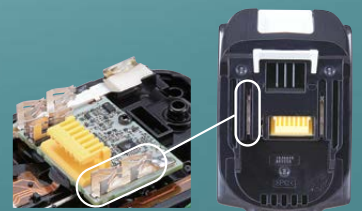

# Li-ion Battery & Charger Time Reference, Compatibility Chart

40Vmax		18V		Fast Charging		DC40RC	Fast Charging		Fast Charging		DC18SD	
 40Vmax Lithium-ion <b>XGT</b>		 18V Lithium-ion <b>LXT</b>		DC40RA (191E08-6)  DC40RB* (191N14-5) 	DC40RC (191M92-9) 	DC40RA + ADP10 (191C11-5) Compatible with LXT Li-Ion batteries 	DC40RC + ADP10 (191C11-5) Compatible with LXT Li-Ion batteries 	DC18RC (195586-8) 110V - (195582-6)  DC18RD* (196934-4)  DC18RE** (198446-3) 	DC18SD (194534-4)  DC18SH*  DC18SE (Automotive) (194621-9) 			
40Vmax Lithium-ion <b>XGT</b>	8.0Ah BL4080F (191X65-8)	76min.	170min.	-	-	-	-	-	-	-	-	
	5.0Ah BL4050F (191L47-8)	50min.	85min.	-	-	-	-	-	-	-	-	
	4.0Ah BL4040F (191O06-8) BL4040 (191B26-6)	45min.	67min.	-	-	-	-	-	-	-	-	
	2.5Ah BL4025 (191B36-3)	28min.	38min.	-	-	-	-	-	-	-	-	
	2.0Ah BL4020 (191L29-0)	22min.	30min.	-	-	-	-	-	-	-	-	
18V Lithium-ion <b>LXT</b>	6.0Ah BL1860B (197422-4)	-	-	40min.	85min.	55min.	130min.	-	-	-	-	
	5.0Ah BL1850B (197280-8)	-	-	35min.	70min.	45min.	110min.	-	-	-	-	
	4.0Ah BL1840B (197265-4)	-	-	29min.	58min.	36min.	90min.	-	-	-	-	
	3.0Ah BL1830B (197599-5)	-	-	22min.	42min.	22min.	60min.	-	-	-	-	
	2.0Ah BL1820B (197254-9)	-	-	24min.	33min.	24min.	45min.	-	-	-	-	
	1.5Ah BL1815N (196449-1)	-	-	15min.	22min.	15min.	30min.	-	-	-	-	
12Vmax Lithium-ion <b>CXT</b>	5.0Ah BL1050B (1913G0-9)	75min.	160min.	 40Vmax Lithium-ion 18V x2 Lithium-ion	35.5Ah PDC1200 360min.	43.55Ah PDC1500 450min.	 40Vmax Lithium-ion 18V x2 Lithium-ion 18V Lithium-ion Power by up to four 18V LXT Batteries					
	4.0Ah BL1041B (197406-2)	60min.	130min.									
	2.0Ah BL1021B (197396-9)	30min.	70min.									
	1.5Ah BL1016 (197393-5)	22min.	50min.									
64Vmax Lithium-ion	10.0Ah BL64100 (191Y69-6)	300min.	10.8V Lithium-ion	1.3Ah BL1013 (196066-7)	50min.	<b>G-Series</b> 18V  14.4V 		DC18WA (195424-4) 				
	4.0Ah BL6440 (191R06-8)	120min.	7.2V Lithium-ion	1.5Ah BL0715 (198000-3)	35min.	18V Lithium-ion	1.5Ah BL1815G   BL1415G (198186-3)   (198192-8)	70min.				
						14.4V Lithium-ion	2.0Ah BL1820G (191N69-0)	90min.				

\* DC40RB / DC18RD / DC18SH: Two Port Multi Fast Charger \*\* DC18RE: CXT & LXT Dual port Fast Charger



## MAKPAC Power Source Kit



<b>QADPSKG1</b> (191V23-2)	Fast Charger (DC40RC), 2X40Vmax - 2.0Ah Batteries (BL4020), Makpac	
<b>QAEPSKG1</b> (191V31-3)	Fast Charger (DC40RC), 2X40Vmax - 2.5Ah Batteries (BL4025), Makpac	
<b>MKP1G001</b> (191J85-8)	Rapid Charger (DC40RA), 2X40Vmax - 2.5Ah Batteries (BL4025), Makpac	
<b>MKP1G002</b> (191K01-6)	Rapid Charger (DC40RA), 2X40Vmax - 4.0Ah Batteries (BL4040), Makpac	
<b>MKPPSKG2</b> (191V42-8)	Rapid Charger (DC40RA), 2X40Vmax - 5.0Ah Batteries (BL4050F), Makpac	
<b>QAAPSKG3</b> (191U06-6)	Dual Port Multi Rapid Charger (DC40RB), 2X40Vmax - 4.0Ah Batteries (BL4040), Makpac	
<b>QABPSKG3</b> (191U20-2)	Dual Port Multi Rapid Charger (DC40RB), 2X40Vmax - 5.0Ah Batteries (BL4050F), Makpac	
<b>QAPSKG3</b> (1910A2-5)	Dual Port Multi Rapid Charger (DC40RB), 2X40Vmax - 8.0Ah Batteries (BL4080F), Makpac	
<b>QACPSKG3</b> (191U34-1)	Dual Port Multi Rapid Charger (DC40RB), 4X40Vmax - 4.0Ah Batteries (BL4040), Makpac	
<b>QADPSKG3</b> (191U48-0)	Dual Port Multi Rapid Charger (DC40RB), 4X40Vmax - 5.0Ah Batteries (BL4050F), Makpac	

## MAKPAC Power Source Kit



<b>MKP1RF182</b> (197974-5)	Rapid Charger (DC18RC), 2X18V - 3.0Ah Batteries (BL1830B), Makpac	
<b>MKP1RT182</b> (197803-2)	Rapid Charger (DC18RC), 2X18V - 5.0Ah Batteries (BL1850B), Makpac	
<b>MKP1RG182</b> (198119-8)	Rapid Charger (DC18RC), 2X18V - 6.0Ah Batteries (BL1860B), Makpac	
<b>MKP3PT182</b> (198182-1)	Dual Port Rapid Charger (DC18RD), 2X18V - 5.0Ah Batteries (BL1850B), Makpac	
<b>MKP3PG182</b> (198081-7)	Dual Port Rapid Charger (DC18RD), 2X18V - 6.0Ah Batteries (BL1860B), Makpac	
<b>MKP3PT184</b> (197627-6)	Dual Port Rapid Charger (DC18RD), 4X18V - 5.0Ah Batteries (BL1850B), Makpac	
<b>MKP3PG184</b> (198095-6)	Dual Port Rapid Charger (DC18RD), 4X18V - 6.0Ah Batteries (BL1860B), Makpac	

## MAKPAC Power Source Kit



<b>MKP1SY122</b> (197654-3)	Fast Charger (DC10SB), 2X12Vmax - 1.5Ah Batteries (BL1016), Makpac	
<b>MKP1SA122</b> (191K13-9)	Fast Charger (DC10SB), 2X12Vmax - 2.0Ah Batteries (BL1021B), Makpac	
<b>MKP1SM122</b> (191K12-1)	Fast Charger (DC10SB), 2X12Vmax - 4.0Ah Batteries (BL1041B), Makpac	

**XGT**

# 40V Li-ion max

High Power

Durability

Digital Communication

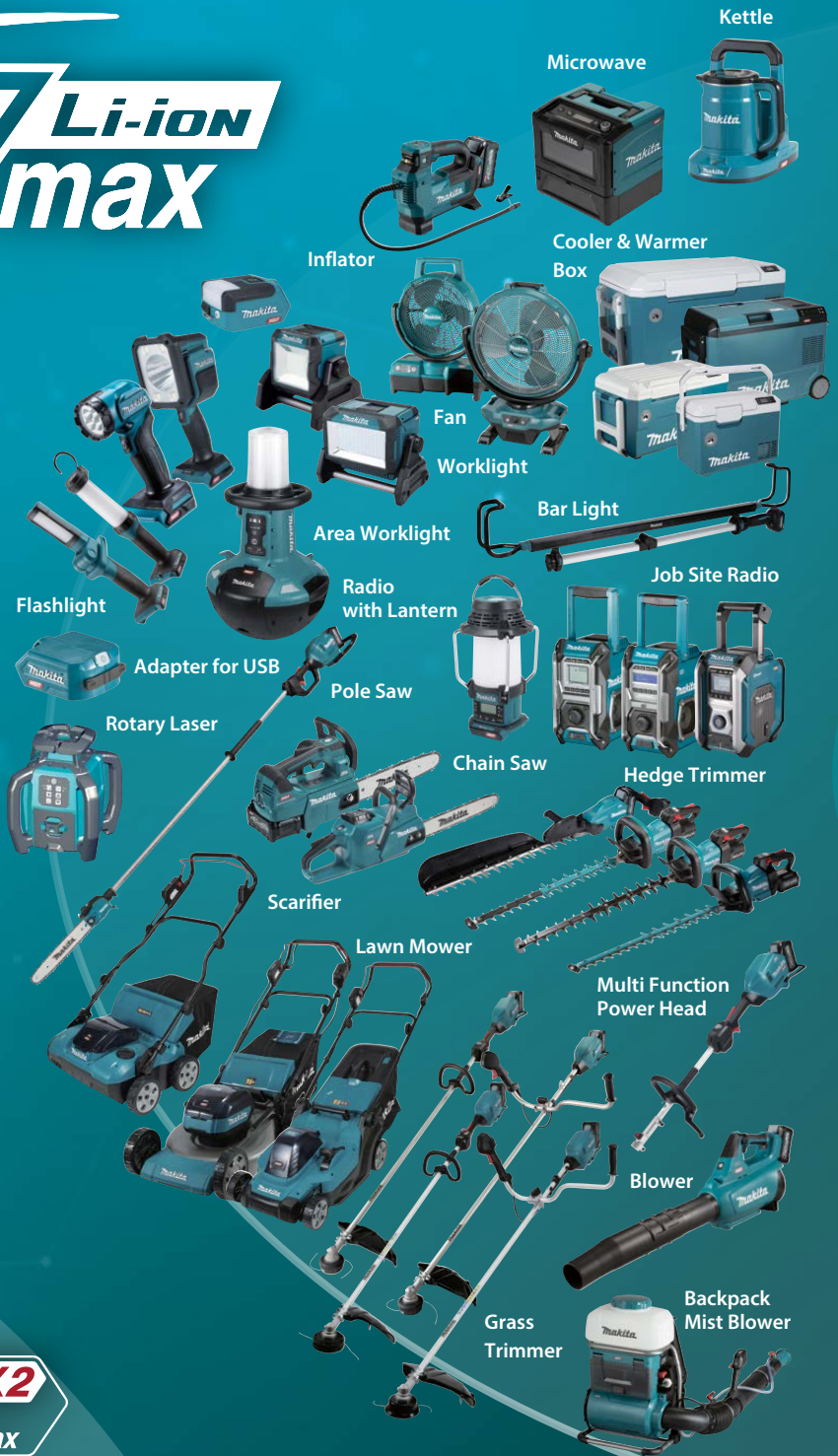

**XGT**

# 40V Li-ion max

**XGT X2**  
80V max

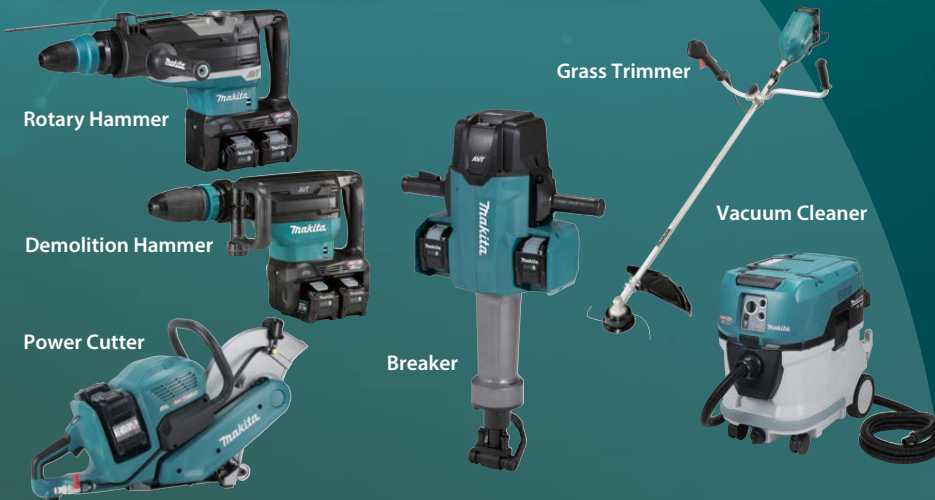

## Battery

BL4020  
2.0Ah

BL4025 /  
BL4025F  
2.5Ah

BL4040 /  
BL4040F  
4.0Ah







Impact Driver

Driver Drill

Hammer Driver Drill

Rotary Hammer

Demolition Hammer

Combination Hammer

Shear Wrench

Brad Nailer

Impact Wrench

Angle Drill

Polisher

Air Compressor



Earth Auger

Mixer

Concrete Vibrator

Angle Grinder

Rear Handle Saw

Circular Saw

Plunge Cut Saw

# 210+ TOOLS

Random Orbit Sander

Orbital Sander

Slide Compound Miter Saw

Metal Cutter

Dust Blower

Recipro Saw

Steel Rod Cutter

Steel Rod Cutter

High Pressure Washer

Backpack Vacuum Cleaner

Planer

Jig Saw

Portable Band Saw

Vacuum Sweeper

Vacuum Cleaner

Upright Cleaner

Cleaner

Trimmer

^ Some models are not for local sale

## Charger

BL4050F 5.0Ah

BL4080F 8.0Ah

DC40RA

DC40RB

DC40WA

DC40RC

ADP10



Adapter for LXT Battery



# 18V LITHIUM-ION



18V Lithium-ion

- Recipro Saw
- Rear Handle Saw
- Portable Cut-off
- Plunge Cut Saw
- Power Cutter
- Angle Grinder
- Rotary Hammer
- Combination Hammer
- Slide Compound Miter Saw
- Circular Saw
- Wall Scanner
- Caulking Gun
- Heat Gun
- Vacuum Pump
- Grease Gun
- Angle Drill
- Shear Wrench
- Backpack Vacuum Cleaner
- Fan Jacket
- Heated Jacket
- Heated Base Layer Shirt
- Cooler & Warmer Box
- Coffee Maker
- Inflator
- Upright Cleaner
- Fan Vest
- Heated Vest
- Worklight
- Heated Blanket
- LED Worklight
- Fan
- Rotary Laser
- Bar Light
- Radio with Lantern
- Job Site Speaker
- Worklight
- Flashlight
- LED Flashlight
- Pruning Shears
- Job Site Radio
- Pruning Saw
- Blower
- Blower Vacuum
- Wheelbarrow
- Chain Saw
- Lawn Mower
- Brad Nailer
- Planer
- Hedge Trimmer
- Grass Shear
- Garden Sprayer
- String Trimmer
- Portable Vacuum Cleaner
- Robotic Cleaner
- Vacuum Cleaner
- Rebar Tying Tool
- Rivet Gun
- Grass Trimmer
- Cleaner
- Dust Blower
- Drywall Saw
- Circular Saw
- Multi Function Power Head
- Cyclone Cleaner
- Vacuum Cleaner
- Stapler
- Cut-Out Tool
- Pin Nailer
- Finish Nailer
- Plate Joiner
- Jig Saw







Chain Saw

Pole Saw

Grass Trimmer

Pruning Shears

Earth Auger

Lawn Mower

Vacuum Pump

High Pressure Washer

Wheelbarrow

Portable Power Pack

Impact Wrench

Vacuum Cleaner

Blower

Kettle

Hedge Trimmer

Multi Function Power Head

Concrete Vibrator

Mixer

4 Mode Impact Driver

Screwdriver

Driver Drill

Oil-Pulse Driver

Auto Feed Screwdriver

Angle Impact Wrench

Impact Driver

Angle Drill

Angle Impact Driver

Ratchet Wrench

Hammer Driver Drill

Rotary Hammer

Die Grinder

Sander Polisher

Power Scraper

Combination Hammer

Steel Rod Cutter

Multi Tool

Random Orbit Polisher

Angle Grinder

Recipro Saw

Metal Shear

Finishing Sander

Angle Grinder

Drywall Sander

Random Orbit Sander

Threaded Rod Cutter

Compact Cut Off

Belt Sander

Nibbler

Cable Cutter

Cutter

Metal Cutter

Portable Band Saw

Slide Compound Miter Saw

Compound Miter Saw

18V x2

440+ TOOLS

6.0Ah 5.0Ah 4.0Ah 3.0Ah 2.0Ah 1.5Ah

^ Some models are not for local sale

Expand Your Lithium Line Up



# 12V<sub>max</sub> LITHIUM-ION

**100+ TOOLS**  
4.0Ah 2.0Ah 1.5Ah

**EXPAND YOUR LITHIUM-ION LINEUP**

- Driver Drill
- Hammer Driver Drill
- Impact Driver
- Angle Drill
- Impact Wrench
- Rotary Hammer
- Ratchet Wrench
- Circular Saw
- Multi Cutter
- Threaded Rod Cutter
- Cutter
- Angle Impact Driver
- Recipro Saw
- Drywall Saw
- Multi tool
- Pin Nailer
- Multi tool
- Jig Saw
- Stapler
- Sander Polisher
- Garden Sprayer
- Caulking Gun
- Pruning Shears
- Pruning Saw
- Hedge Trimmer
- Blower
- Grass Trimmer
- Grass Shear
- Blower
- Inflator
- Blower
- LED Worklight
- Worklight
- Cordless Cleaner
- Worklight
- Fan Jacket
- Fan Vest
- Fan
- Heated Jacket
- Heated Vest
- Heated Base Layer Shirt
- Heated Blanket
- Green 4-point Cross Line Laser
- Red 4-point Cross Line Laser
- Multi Line Laser
- Rotary Laser
- Job Site Speaker
- Job Site Radio
- Adapter for USB



^ Some models are not for local sale





# 10.8V Lithium-ion



# 7.2V Lithium-ion



^ Some models are not for local sale

# A wide variety of Lithium-ion Garden Tools

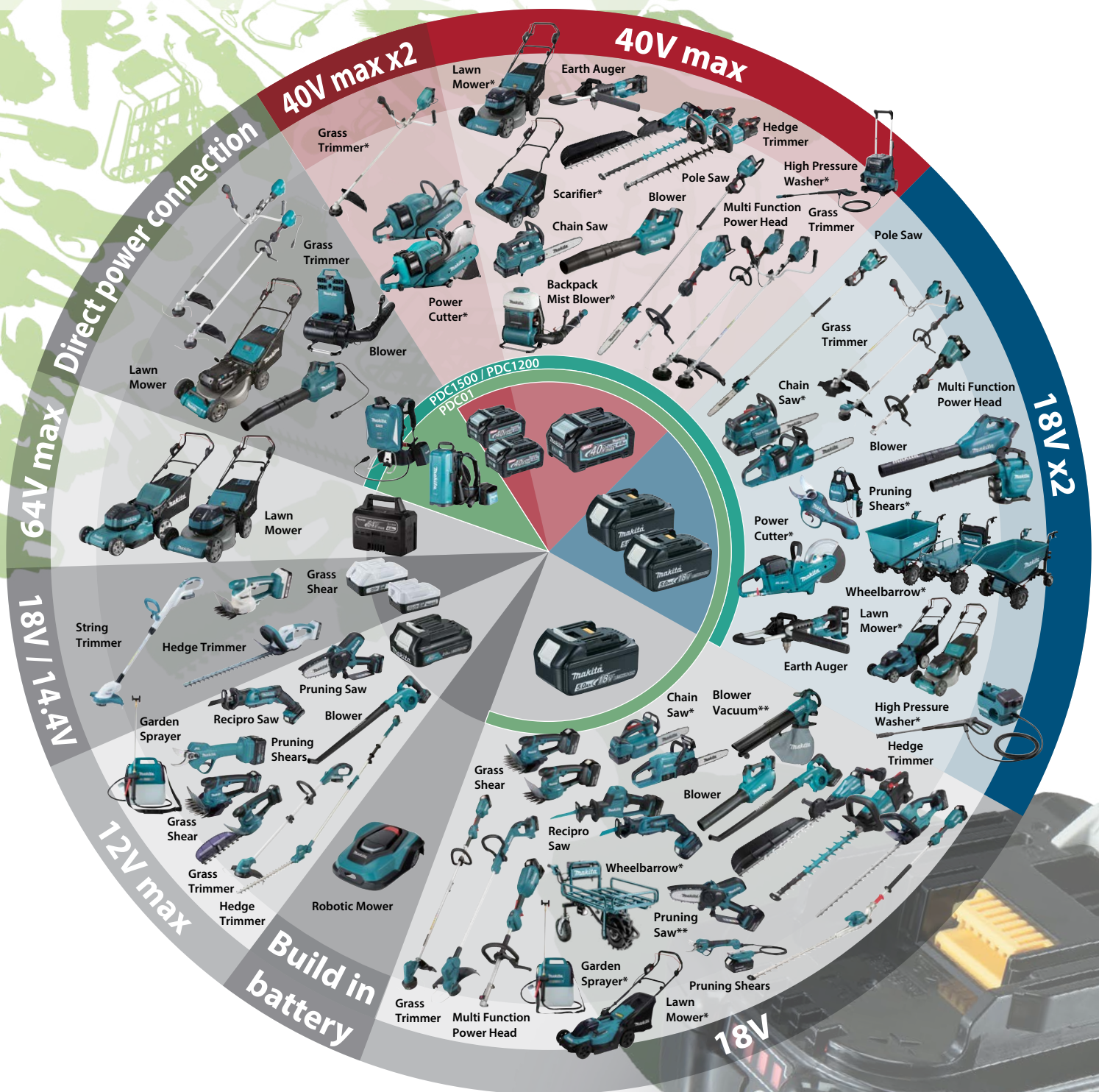

\* These models are not compatible with Portable Power Pack (PDC1500, PDC1200, PDC01)  
 Only rear handle type chainsaws are compatible  
 \*\* These models are not compatible with Portable Power Pack (PDC1500, PDC1200)  
 ^ Some models are not for local sale



## Portable Power Pack

### 1,500Wh-class high capacity

Portable Power Pack  
**PDC1500**

**More robust appearance and increased strength**

Achieved by:

- New stand with increased strength obtained by using a larger diameter metal pipe
- Metalized junctions between battery and harness



**Height-adjustable waist belt**



**Quickly removable harness**



**Reflectors**

**Compatible with a wide range of applications**  
(both in backpack and stationary styles)



**PDC1500**



**PDC1200**



**Charger DC4001**

Part No. 191L01-2

Charging time

PDC1500: 450 min.

PDC1200: 360 min.



**PDC01**

**Powered by up to four 18V LXT batteries**  
**432 Wh high capacity**  
(with 4 pcs. of BL1860B)  
(Batteries sold separately)



**IPX4**

### PDC1200A01 / A02 Portable Power Pack

1,200 Wh high capacity



Capacity	33.5 Ah
Energy Capacity	1,206 Wh
Number of Cells	100
Charging Time (hours)	6
Power Supply Cord	Battery Side: 1.1 m (3.6 ft) Adapter Side: 0.6 m (2.0 ft)
Dimensions (L x W x H)	w/o Harness: 369 x 261 x 139 mm (14-1/2 x 10-1/4 x 5-1/2") w/ Harness: 428 x 261 x 164 mm (16-7/8 x 10-1/4 x 6-1/2")
Net weight	8.8 kg (19.4 lbs.)

40Vmax 18V x2 XGT LXT IPX4 WG

Harness, Charger. \* PDC1200A01 (1x 18V+18V Adaptor)

## Power Converter

### Transform DC power into AC power instantly!

- Power converter powered by Makita portable power pack
- Turns DC power into AC power, is optimal for a wide range of applications
- Battery charging or use of corded tools in outdoor job sites where AC outlet is not available
- Emergency power source of outdoor leisure activities
- 7-stage output indication by 7 LED lamps
- Can be connected firmly with accessories of MAKPAC system, allowing for easy transportation on MAKPAC trolley or cart



Power Converter  
**BAC01**



### PDC1500A01 Portable Power Pack

**New**

1,500Wh-class High Capacity, High Output Power



Capacity	43.55 Ah
Energy capacity	1,567.8 Wh
Number of cells	130
Charging time	450 min.
Dimensions (L x W x H)	w/o Harness: 369 x 312 x 131 mm (14-1/2 x 12-1/4 x 5-1/8")
Net weight	10.9 - 12.9 kg (24.0 - 28.4 lbs.)*
Power supply cord	Battery side: 1.2 m (3.9 ft) Adapter side: 0.6 m (2.0 ft)

40Vmax 18V x2 XGT LXT IPX4 WG 1

Harness, Charger. \*not covered by EPTA-Procedure

### PDC01 (191A62-6 / 191A67-6) Portable Power Pack

Powered by up to four 18V LXT batteries

Li-ion Ah 6.0 | 5.0 | 3.0 | 1.5



Capacity	24 / 12 Ah
Energy Capacity	432 Wh
Dimensions (L x W x H)	400x195x132mm (15-3/4"x7-5/8"x5-3/16")
Net weight	1.7 kg (5.6 lbs.)

18V x2 18V XGT LXT IPX4

Harness, Adapter. \* 191A62-6 (18V+18V and 18V Adaptor), 191A67-6 (18V + 18V Adaptor only)

# DRILL

## Steel & Wood

### PRODUCTS



#### DF001GM201(RM2J) / GD201(RD2J) / GZ 13mm (1/2") Cordless Driver Drill

Excellent in Continuous Heavy-Duty Work

Li-ion Ah 8.0 5.0 4.0 2.5 2.0



Capacity	Steel: 20mm (13/16") Wood (Auger-Bit): 50mm (2") Wood (Self-Feed Bit): 76mm (3") Wood (Hole Saw): 152mm (6")
Chuck Capacity	1.5 - 13mm (1/16 - 1/2")
No Load Speed (RPM)	High / Low: 0 - 2,600 / 0 - 650
Max Fastening Torque	Hard / Soft: 140 / 68 N·m
Max lock torque	125 N·m (1,100 in.lbs.)
Dimensions (L x W x H)	w/ BL4025: 181x86x275 mm w/ BL4040: 181x86x282 mm
Net weight	2.7 - 3.0 kg (5.9 - 6.6 lbs.)

40Vmax



XGT BL AFT XPT

Side Handle, Belt Clip, (+/-) Bit, Bit Holder, Charger, Battery, Z: Battery and Charger are sold separately

#### DF002GD201(RD2J) / GA201(SA2J) / GZ 13mm (1/2") Cordless Driver Drill

Compact and ergonomic design at only 170 mm (6-11/16") long

Li-ion Ah 5.0 4.0 2.5 2.0



Capacity	Steel/Wood: 13/38mm (1/2"/1-1/2") Chuck Capacity 1.5 - 13mm (1/16 - 1/2")
No Load Speed (RPM)	High / Low: 0 - 2,200 / 0 - 600
Max Fastening Torque	Hard / Soft: 64 / 30 N·m (570 / 270 in.lbs.)
Max lock torque	65 N·m (580 in.lbs.)
Dimensions (L x W x H)	w/ BL4025: 170x86x265 mm w/ BL4040: 170x86x290 mm
Net weight	1.9 - 2.8 kg (4.2 - 6.2 lbs.)

40Vmax



XGT BL AFT XPT

(+/-) Bit, Belt Clip, Battery, Charger, Z: Battery and Charger are sold separately

#### DDF486RTE / RFE / Z 13mm (1/2") Cordless Driver Drill

18V LXT BL Brushless Cordless 13 mm (1/2") 125 N·m (1,100 in.lbs.)

Li-ion Ah 6.0 5.0 3.0 1.5



Capacity	Steel: 13 mm (1/2"), Wood (Auger-Bit): 50 mm (2") Wood (Self-Feed Bit): 76 mm (3") Wood (Hole Saw): 152mm (6"), Sliding Board: 170 mm (6-11/16")
Chuck capacity	1.5 - 13 mm (1/16 - 1/2")
No Load Speed (RPM)	High / Low: 0 - 2,100 / 0 - 550
Max Fastening Torque	Hard / Soft: 130 / 65 N·m
Max lock torque	125 N·m (1,100 in.lbs.)
Dimensions (L x W x H)	w/ BL1830B / BL1850B / BL1860B: 178 x 81 x 265 mm
Net weight	2.3 - 2.6 kg (5.1 - 5.7 lbs.)

18V



LXT BL XPT

Depth Gauge, Side Handle, Belt Clip, (+/-) Bit, Bit Holder, Charger, Battery, Z: Battery and Charger are sold separately

#### DDF458RTE / RFE 13mm (1/2") Cordless Driver Drill

Cordless 13 mm (1/2") 84 N·m (750 in.lbs.) Driver Drill

440

Li-ion Ah 6.0 5.0 3.0 1.5



Capacity	Steel: 13 mm (1/2") Wood: 76 mm (3")
No Load Speed (RPM)	High: 0 - 2,000 Low: 0 - 400
Max Fastening Torque	Hard / Soft: 91 / 58 N·m
Max lock torque	84 N·m (750 in.lbs.)
Dimensions (L x W x H)	225x79x259 mm (8-7/8"x3-1/8"x10-1/4")
Net weight	2.1 - 2.5 kg (4.7 - 5.4 lbs.)

18V



LXT XPT

Charger, Battery, (+/-) Bit, Side Grip, Z: Battery and Charger are sold separately

#### DDF484RTE / RFE / Z 13mm (1/2") Cordless Driver Drill

Cordless 13 mm (1/2") 60 N·m (530 in.lbs.) Driver Drill

Li-ion Ah 6.0 5.0 3.0 1.5



Capacity	Steel / Wood: 13 / 38 mm (1/2" / 1-1/2")
Chuck capacity	1.5 - 13 mm (1/16 - 1/2")
No Load Speed (RPM)	High / Low: 0 - 2,000 / 0 - 500
Max Fastening Torque	Hard / Soft: 54 / 30 N·m (480 / 270 in.lbs.)
Max lock torque	60 N·m (530 in.lbs.)
Sound Power Level	N/A dB(A)
Dimensions (L x W x H)	172x79x261 mm (6-3/4"x3-1/8"x10-1/4")
Net weight	1.5 kg (3.4 lbs.)

18V



LXT BL XPT

(+/-) bit 2-45, Belt clip, Battery, Fast Charger, Z: Battery and Charger are sold separately

#### DDF482RTE / RFE / Z 13mm (1/2") Cordless Driver Drill

Developed as the successor to the current model DDF456

440

Li-ion Ah 6.0 5.0 3.0 1.5



Capacity	Steel / Wood: 13 / 38 mm (1/2" / 1-1/2")
Chuck capacity	1.5 - 13 mm (1/16 - 1/2")
No Load Speed (RPM)	High / Low: 0 - 1,900 / 0 - 600
Max Fastening Torque	Hard / Soft: 62 / 36 N·m (550 / 320 in.lbs.)
Max lock torque	54 N·m (480 in.lbs.)
Dimensions (L x W x H)	185x79x249 mm (7-1/4"x3-1/8"x9-3/4")
Net weight	1.5 kg (3.3 lbs.)

18V



LXT XPT

Fast Charger, Battery Cartridge, (+) (-) Bit, Z: Battery and Charger are sold separately



**DDF489RTJ / Z** 13mm (1/2") Cordless Driver Drill **New**

18V LXT BL Cordless 13 mm (1/2"), Excellent drilling capacity

Li-ion Ah 6.0 | 5.0 | 3.0 | 1.5



Capacity	Steel: 13 mm (1/2"), Wood (Auger-Bit): 38 mm (1-1/2"), Wood (Self-Feed Bit): 51 mm (2"), Wood (Hole Saw): 51 mm (2"), Siding Board: 70 mm (2-3/4")
Chuck capacity	1.5 - 13 mm (1/16 - 1/2")
No Load Speed (RPM)	High / Low: 0 - 1,800 / 0 - 550
Max Fastening Torque	Hard / Soft: 73 / 40 N-m
Max lock torque	80 N-m (700 in.lbs.)
Dimensions (L x W x H)	w/ BL1830B / BL1850B / BL1860B: 174 x 81 x 261 mm
Net weight	1.8 - 2.5 kg (4.0 - 5.5 lbs.)

18V **LXT BL XPT**

Belt clip, (+/-) Bit, Battery, Charger, Z: Battery and Charger are sold separately

**DDF487RFJ / Z** 13mm (1/2") Cordless Driver Drill

18V LXT BL Brushless Cordless 13 mm (1/2") 40 N-m (350 in.lbs.)

Li-ion Ah 6.0 | 5.0 | 3.0 | 1.5



DDF487RFJ  
1

Capacity	Steel / Wood (Auger Bit) / Wood (Self-Feed Bit) / Wood (Hole Saw): 13 / 36 / 35 / 51 mm (1/2 / 1-7/16 / 1-3/8 / 2")
Chuck Capacity	1.5 - 13 mm (1/16 - 1/2")
No Load Speed (RPM)	High / Low: 0 - 1,700 / 0 - 500
Max Fastening Torque	Hard / Soft: 40 / 25 N-m
Max Lock Torque	40 N-m (350 in.lbs.)
Dimensions (L x W x H)	w/ BL1830B / BL1850B / BL1860B: 150 x 81 x 248 mm (5-7/8 x 3-1/16 x 9-3/4")
Net weight	1.3 - 1.6 kg (2.9 - 3.5 lbs.)

18V **LXT BL XPT**

Belt Clip, (+/-) Bit, Battery, Charger, Z: Battery and Charger are sold separately

**DF488D004 / DYEX4** 13mm (1/2") Cordless Driver Drill

18V Li-Ion Cordless 13 mm (1/2") 38 N-m (340 in.lbs.) Driver Drill, G-Battery

Li-ion Ah 2.0 | 1.5



Capacity	Steel: 13 mm (1/2") Wood: 36 mm (1-7/16")
No Load Speed (RPM)	High: 0 - 1,400 Low: 0 - 400
Max Fastening Torque	Hard / Soft: 42 / 24 N-m
Max lock torque	38 N-m (340 in.lbs.)
Dimensions (L x W x H)	221 x 83 x 240 mm (8-3/4 x 3-1/4 x 9-1/2")
Net weight	1.7 kg (3.7 lbs.)

18V **G-Series**

(+/-) Bit, Battery, Charger

**DF332DSAE / DZ** 10mm (3/8") Cordless Driver Drill

Extremely Compact and Lightweight

Li-ion Ah 5.0 | 4.0 | 2.0 | 1.5



DF332DSAE  
2  
DF332DZ  
4

Capacity	Steel: 10 mm (3/8") Wood: 28 mm (1-1/8")
Chuck Capacity	0.8 - 10 mm (1/32 - 3/8")
No Load Speed (RPM)	High: 0 - 1,500 Low: 0 - 450
Max Fastening Torque	Hard: 35 N-m Soft: 21 N-m
Max Lock Torque	32 N-m (280 in.lbs.)
Max Output	250W
Dimensions (L x W x H)	154x66x217mm (6-1/16"x2-5/8"x8-1/2")
Net Weight	1 - 1.2 kg (2.3 - 2.6 lbs)

12Vmax **CXT BL XPT**

Battery, Charger, Battery cover, Belt clip, Phillips bit, DZ: Battery and Charger are sold separately

**DF333DSAE / DZ** 10mm (3/8") Cordless Driver Drill

12Vmax CXT Li-Ion Cordless 28 N-m (250 in.lbs.) Driver Drill

Li-ion Ah 5.0 | 4.0 | 2.0 | 1.5



DF333DSAE  
2  
DF333DZ  
4

Capacity	Steel / Wood: 10 / 21 mm (3/8" / 13/16")
Chuck capacity	0.8 - 10 mm (1/32 - 3/8")
No Load Speed (RPM)	High / Low: 0 - 1,700 / 0 - 450
Max Fastening Torque	Hard / Soft: 30 / 14 N-m (270 / 130 in.lbs.)
Max lock torque	28 N-m (250 in.lbs.)
Dimensions (L x W x H)	w/ BL1016/BL1021B: 179x66x212 mm w/ BL1041B: 179x66x229 mm
Net weight	1.1 - 1.2 kg (2.4 - 2.7 lbs.)

12Vmax **CXT**

Phillips Bit, Belt Clip, Battery, Charger, DZ: Battery and Charger are sold separately

**DF330DWE** 10mm (3/8") Cordless Driver Drill

Lightweight and compact but with 2-speed gear selection

Li-ion Ah 1.3



Capacity	Steel: 10 mm (3/8") Wood: 21 mm (13/16")
No Load Speed (RPM)	High: 0 - 1,300 Low: 0 - 350
Max Fastening Torque	Hard / Soft: 24 / 14 N-m
Dimensions (L x W x H)	189x53x183mm (7-7/16"x2-1/16"x7-1/4")
Net Weight	1.0kg (2.2lbs)

10.8V **5**

Battery Charger, Battery Cartridge, Phillips Bit, Holster

**CORDLESS COMBO KIT**

**DLX2131JX7**

**18V LITHIUM-ION**



Casing x1  
DTH152Z x1  
DHP482Z x1  
BL1830B x3  
DC18RC x1

**CLX224SAX1**

**12Vmax LITHIUM-ION**



Aluminium Casing x1  
TD110DZ x1  
DC10SB x1  
DF333DZ x1  
BL1021B x2

**LCT204**

**10.8V LITHIUM-ION**



Aluminium Casing x1  
DC10WA x2  
BL1013 x1  
DF330DZ x1  
TD090DZ x1



**DDF083RFE / Z 13mm (1/2") Cordless Driver Drill**

Ultra-compact and slim design

Li-ion Ah 6.0 | 5.0 | 3.0 | 1.5



DDF083RFE

2

DDF083Z

6

Capacity	Steel / Wood: 13 / 36 mm (1/2" / 1-7/16")
Chuck capacity	6.35mm (1/4")
No Load Speed (RPM)	High / Low: 0 - 1,700 / 0 - 500
Max Fastening Torque	Hard / Soft: 40 / 23 N-m (350 / 210 in.lbs.)
Max lock torque	40 N-m (350 in.lbs.)
Sound Power Level	77 dB(A)
Dimensions (L x W x H)	124x79x247mm (4-7/8"x3-1/8"x9-3/4")
Net weight	1.1 kg (2.4 lbs)

18V



LXT BL XPT

Belt Clip, Battery, Fast Charger, Phillips bit, Z: Battery and Charger are sold separately

**DF032DSAE / DZ 10mm (3/8") Cordless Driver Drill**

BL motor delivers 35 N-m of max torque

Li-ion Ah 5.0 | 4.0 | 2.0 | 1.5



DF032DSAE

2

DF032DZ

4

Capacity	Steel: 10mm (3/8") Wood: 28mm (1-1/8")
Chuck Capacity	6.35mm (1/4")
No Load Speed (RPM)	High: 0-1,500 Low: 0-450
Max Fastening Torque	Hard: 35 N-m Soft: 21 N-m
Max Lock Torque	32 N-m (280 in.lbs.)
Max Output	250W
Dimensions (L x W x H)	124x66x217mm (4-7/8"x2-5/8"x8-1/2")
Net Weight	0.88 kg (1.9 - 2.3lbs)

12Vmax



XPT BL XPT

Battery, Charger, Battery cover, Belt clip, Phillips bit, DZ: Battery and Charger are sold separately

**DF033DZ 10mm (3/8") Cordless Driver Drill**

12Vmax CXT Li-Ion Cordless 28 N-m (250 in.lbs.) Driver Drill

Li-ion Ah 5.0 | 4.0 | 2.0 | 1.5



Capacity	Steel / Wood: 10 / 21 mm (3/8" / 13/16")
Chuck capacity	6.35 mm (1/4")
No Load Speed (RPM)	High / Low: 0 - 1,700 / 0 - 450
Max Fastening Torque	Hard / Soft: 30 / 14 N-m (270 / 130 in.lbs.)
Max lock torque	28 N-m (250 in.lbs.)
Dimensions (L x W x H)	w/ BL1016/BL1021B: 149x66x212 mm w/ BL1041B: 149x66x229 mm
Net weight	0.92 - 1.1 kg (2.0 - 2.4 lbs.)

12Vmax



CXT

Phillips Bit, Belt Clip, Battery, Charger, DZ: Battery and Charger are sold separately

**DF012DSE Cordless Driver Drill**

7.2V Li-Ion Cordless 5 mm (3/16") Driver Drill

Li-ion Ah 1.5



Capacity	Steel: 5 mm (3/16") Wood: 6 mm (1/4")
No Load Speed (RPM)	High: 650 Low: 200
Max Fastening Torque	Hard / Soft: 5.6 / 3.6 N-m
Dimensions Straight Type (L x W)	273x44mm (10-3/4"x1-3/4")
Dimensions Pistol Type (L x W x H)	218x44x142mm (8-5/8"x1-3/4"x5-5/8")
Net Weight	0.56 kg (1.21 lbs.)

7.2V



5

Bit set, Battery, Charger

**DF001DW In-Line Cordless Screwdriver**

3.6V Li-Ion Cordless Screwdriver, Built-in Battery

Li-ion Ah 1.5



No Load Speed (RPM)	220
Max Fastening Torque	Hard: 4.0 N-m (35 in.lbs.) Soft: 3.0 N-m (27 in.lbs.)
Max Lock Torque	6.0 N-m (53 in.lbs.)
Charging Time (hours)	3 - 5
Dimensions (L x W x H)	Straight Style: 287 x 47 x 51 mm Pistol Style: 205x47x51 mm (8-1/8"x1-7/8"x2")
Net Weight	0.36 kg (0.79 lbs)

3.6V



5

Bit set, AC Adaptor

**DF0300 10mm (3/8") Driver Drill**

10 mm (3/8") 320 W Driver Drill with Keyless Chuck

411



Continuous rating input	320W
Capacity	Steel / Wood: 10 / 28mm (3/8" / 1-1/8")
Chuck Capacity	1.0 - 10 mm (1/32 - 3/8")
No Load Speed (RPM)	High / Low: 0 - 1,500 / 0 - 450
Max Fastening Torque	Hard / Soft: 56.0 / 21.0 N-m (500 / 190 in.lbs.)
Max lock torque	42.0 N-m (370 in.lbs.)
Sound Power Level	91 dB(A)
Dimensions (L x W x H)	220x67x206 mm (8-5/8"x2-5/8"x8-1/8")
Net weight	1.2 kg (2.7 lbs.)
Power supply cord	2.5 m (8.2 ft)



6

Bit

**DDA351Z 10mm (3/8") Cordless Angle Drill**

18V LXT Li-Ion Cordless 10 mm (3/8") Angle Drill, Keyless Chuck

440

Li-ion Ah 6.0 | 5.0 | 3.0 | 1.5



Capacity	Steel: 10 mm (3/8") Wood: 25 mm (1")
No Load Speed (RPM)	0-1,800
Dimensions (L x W x H)	326x79x115 mm (12-7/8"x3-1/8"x4-1/2")
Net Weight	1.6 - 1.9 kg (4.2 - 3.5 lbs.)

18V



LXT 5

Charger, Battery, Side Grip, Z: Battery and Charger are sold separately



**DA333DSAE / DZ 10mm (3/8") Cordless Angle Drill**

12Vmax CXT Li-Ion Cordless 10 mm (3/8") Angle Drill, Keyless Chuck

Li-ion Ah 5.0 4.0 2.0 1.5



Capacity	Steel: 10 mm (3/8") Wood: 12 mm (1/2")
No Load Speed (RPM)	0 - 1,100
Head Height	84 mm (3-5/16")
Center Height	23.5 mm (15/16")
Dimensions (L x W x H)	313x68x95 mm (12-3/8"x2-11/16"x3-3/4")
Net Weight	1.2 - 1.4 kg (2.7 - 3.0 lbs)



12Vmax



Bit, Belt Clip, Battery, Charger, DZ: Battery and Charger are sold separately

**DA3010F 10mm (3/8") Angle Drill**

Compact and light body weighs only 1.4kg (3.1lbs)

419



Continuous Rating Input	450W
Capacity	Steel: 10 mm (3/8") Wood: 25 mm (1")
No Load Speed (RPM)	0-2,400
Overall Length	270 mm (10-5/8")
Net Weight	1.6kg (3.5lbs)
Power Supply Cord	2.5m (8.2ft)



Chuck Key S10, Grip 36 Complete

**6412 10mm (3/8") Drill**

Compact and lightweight, yet with enough power

64

110V

6412/B



Continuous Rating Input	450W
Capacity	Steel: 10 mm (3/8") Wood: 25 mm (1")
No Load Speed (RPM)	0 - 3,400
Dimensions (L x W x H)	228x64x183mm (9"x2-1/2"x7-1/4")
Net Weight	1.3kg (2.9lbs)
Power Supply Cord	2.0m (6.6ft)



Chuck Key

**6413 10mm (3/8") Drill**

Compact and lightweight, yet with enough power

64



Continuous Rating Input	450W
Capacity	Steel: 10 mm (3/8") Wood: 25 mm (1")
No Load Speed (RPM)	0-3,400
Dimensions (L x W x H)	234x64x183mm (9-1/4"x2-1/2"x7-1/4")
Net Weight	1.3kg (2.9lbs)
Power Supply Cord	2.0m (6.6ft)



**6305 13mm (1/2") Drill**

13 mm (1/2") 850 W Drill with Keyed Chuck

303



Continuous rating input	850W
Capacity	Steel: 13 mm (1/2") Wood: 30 mm (1-3/16")
No Load Speed (RPM)	1,450
Dimensions (L x W x H)	346x84x152 mm (13-5/8"x3-5/16"x6")
Net weight	2.8 kg (6.2 lbs.)
Power supply cord	2.5 m (8.2 ft)



Chuck Key, Depth Gauge, Side Grip

**DP4002/B 13mm (1/2") Drill**

Lightweight aluminum gear housing for durability

419



Continuous rating input	750W
Capacity	Steel: 13 mm (1/2") Wood: 38 mm (1-1/2")
No Load Speed (RPM)	0-700
Overall Length	304 mm (12")
Net weight	2.7 kg (5.8 lbs.)
Power supply cord	2.5 m (8.2 ft)



**DP4700 13mm (1/2") Drill**

Heavy-duty performance drill for professionals

64



Continuous Rating Input	510W
Capacity	Steel: 13 mm (1/2") Wood: 36 mm (10-7/8")
No Load Speed (RPM)	0-550
Overall Length	275 mm (10-7/8")
Net Weight	2.2kg (4.8lbs)
Power Supply Cord	2.5m (8.2ft)



Chuck Key, Side Grip

**DS4011 13mm (1/2") Drill**

New aesthetic design

411



Continuous Rating Input	750W
Capacity	Steel: 13 mm (1/2") Wood: 36 mm (1-7/16")
No Load Speed (RPM)	600
Dimensions (L x W x H)	340x83x401mm (13-3/8"x3-1/4"x15-3/4")
Net Weight	2.8kg (6.3lbs)
Power Supply Cord	2.5m (8.2ft)



Chuck Key, Side Grip

# HAMMER DRILL

Steel, Wood & Masonry

## PRODUCTS



### HP001GM201(RM2J) / GD201(RD2J) / GZ 13mm (1/2") Cordless Hammer Driver Drill

Delivers 35% or more higher speed than previous model

Li-ion Ah 8.0 5.0 4.0 2.5 2.0



Capacity	Steel: 20 mm (13/16") Wood (Auger-Bit): 50 mm (2") Wood (Self-Feed Bit): 76 mm (3") Wood (Hole Saw): 152 mm (6") Masonry: 20 mm (13/16")
Chuck Capacity	1.5 - 13 mm (1/16 - 1/2")
Impacts Per Minute (IPM)	High/Low: 0 - 39,000 / 0 - 9,750
No Load Speed (RPM)	High/Low: 0 - 2,600 / 0 - 650
Max Fastening Torque	Hard/Soft: 140 / 68 N·m
Max lock torque	125 N·m (1,100 in.lbs.)
Dimensions (L x W x H)	w/BL402S: 182x86x275 mm w/BL4040: 182x86x282 mm
Net weight	2.7 - 3.0 kg (6.0 - 6.6 lbs.)

40Vmax **LXT BL AFT XPT**

Depth Gauge, Side Handle, Belt Clip, (+/-) Bit, Bit Holder, Charger, Battery, Z: Battery and Charger are sold separately

### HP002GD201(RD2J) / GA201(SA2J) / GZ 13mm (1/2") Cordless Hammer Driver Drill

Compact and ergonomic design at only 180 mm (7-1/8") long

Li-ion Ah 5.0 4.0 2.5 2.0



Capacity	Steel/Wood/Masonry: 13/38/13 mm (1/2/1-1/2/1/2") 1.5 - 13 mm (1/16 - 1/2")
Chuck Capacity	1.5 - 13 mm (1/16 - 1/2")
Impacts Per Minute (IPM)	High/Low: 0 - 33,000 / 0 - 9,000
No Load Speed (RPM)	High/Low: 0 - 2,200 / 0 - 600
Max Fastening Torque	Hard/Soft: 64/30 N·m (570/270 in.lbs.)
Max lock torque	65 N·m (580 in.lbs.)
Dimensions (L x W x H)	w/BL402S: 180x86x265 mm w/BL4040: 180x86x290 mm
Net weight	2.0 - 2.9 kg (4.4 - 6.4 lbs.)

40Vmax **LXT BL AFT XPT**

Belt Clip, (+/-) Bit, Battery, Charger, Z: Battery and Charger are sold separately

### DHP486RTE / Z 13mm (1/2") Cordless Hammer Driver Drill

18V LXT BL Brushless Cordless 13 mm (1/2") 125 N·m (1,100 in.lbs.)

Li-ion Ah 6.0 5.0 3.0 1.5



Capacity	Steel: 13 mm (1/2"), Wood (Auger-Bit): 50 mm (2") Masonry: 16 mm (5/8"), Siding Board: 170 mm (6-11/16")
Chuck capacity	1.5 - 13 mm (1/16 - 1/2")
Impacts Per Minute (IPM)	High/Low: 0 - 31,500 / 0 - 8,250
No Load Speed (RPM)	High/Low: 0 - 2,100 / 0 - 550
Max Fastening Torque	Hard/Soft: 130 / 65 N·m
Max lock torque	125 N·m (1,100 in.lbs.)
Dimensions (L x W x H)	w/BL1830B/BL1850B/BL1860B: 178x81x265 mm
Net weight	2.3 - 2.7 kg (5.1 - 6.0 lbs.)

18V **LXT BL AFT XPT**

Depth Gauge, Side Handle, Belt Clip, (+/-) Bit, Bit Holder, Charger, Battery, Z: Battery and Charger are sold separately

### DHP484RTE / RFE / Z 13mm (1/2") Cordless Hammer Driver Drill

Cordless 13 mm (1/2") 60 N·m (530 in.lbs.) Hammer Driver Drill

Li-ion Ah 6.0 5.0 3.0 1.5



Capacity	Steel: 13 mm (1/2") Wood: 38 mm (1-1/2") Masonry: 13 mm (1/2")
Impacts Per Minute (IPM)	High/Low: 0 - 30,000 / 0 - 7,500
No Load Speed (RPM)	High/Low: 0 - 2,000 / 0 - 500
Max Fastening Torque	Hard/Soft: 54 / 30 N·m (480 / 270 in.lbs.)
Max lock torque	60 N·m (530 in.lbs.)
Sound Power Level	99 dB(A)
Dimensions (L x W x H)	182x79x261 mm
Net weight	(7-1/8"x3-1/8"x10-1/4") 1.6 kg (3.5 lbs)

18V **LXT BL AFT XPT**

Fast Charger, Battery Cartridge, (+/-) Bit, Side Grip, Z: Battery and Charger are sold separately

### DHP482RTE / RFX1 / RFE / Z 13mm (1/2") Cordless Hammer Driver Drill

Extremely compact tool size

440 mm

Li-ion Ah 6.0 5.0 3.0 1.5



Capacity	Steel: 13 mm (1/2") Wood: 38 mm (1-1/2") Masonry: 13 mm (1/2")
Impacts Per Minute (IPM)	High/Low: 0 - 28,500 / 0 - 9,000
No Load Speed (RPM)	High/Low: 0 - 1,900 / 0 - 600
Max Fastening Torque	Hard/Soft: 62 / 36 N·m (550 / 320 in.lbs.)
Max lock torque	54 N·m (480 in.lbs.)
Dimensions (L x W x H)	198x79x249 mm
Net weight	(7-3/4"x3-1/8"x9-3/4") 1.5 kg (3.4 lbs)

18V **LXT XPT**

Battery, Fast Charger, (+/-) Bit 2-45, Belt clip, Z: Battery and Charger are sold separately

### DHP489RTJ / Z 13mm (1/2") Cordless Hammer Driver Drill

New

18V LXT BL Cordless 13 mm (1/2"), Excellent drilling capacity

Li-ion Ah 6.0 5.0 3.0 1.5



Capacity	Steel: 13 mm (1/2"), Wood (Auger-Bit): 38 mm (1-1/2"), Masonry: 16 mm (5/8"), Siding Board: 70 mm (2-3/4")
Chuck capacity	1.5 - 13 mm (1/16 - 1/2")
Impacts Per Minute (IPM)	High/Low: 0 - 27,000 / 0 - 8,250
No Load Speed (RPM)	High/Low: 0 - 1,800 / 0 - 550
Max Fastening Torque	Hard/Soft: 73 / 40 N·m
Max lock torque	80 N·m (700 in.lbs.)
Dimensions (L x W x H)	w/w/BL1830B/BL1850B/BL1860B: 175x81x261 mm
Net weight	1.8 - 2.5 kg (4.0 - 5.5 lbs.)

18V **LXT BL AFT XPT**

Belt clip, (+/-) Bit, Battery, Charger, Z: Battery and Charger are sold separately





**DHP487RFJ / Z**  
13mm (1/2") Cordless Hammer Driver Drill

18V LXT BL Brushless Cordless 13 mm (1/2") 40 N-m (350 in.lbs.)

Li-ion Ah 6.0 5.0 3.0 1.5



DHP487RFJ

5

DHP487Z

6

Capacity	Steel/Wood (Auger Bit) / Wood (Self-Feed Bit) / Wood (Hole Saw) / Masonry: 13 / 36 / 35 / 51 / 13 mm (1/2-1-7/16 / 1-3/8 / 2 / 1-1/2")
Chuck Capacity	1.5-13 mm (1/16 - 1/2")
Impacts Per Minute (IPM)	High/Low: 0 - 25,500 / 0 - 7,500
No Load Speed (RPM)	High/Low: 0 - 1,700 / 0 - 500
Max Fastening Torque	Hard / Soft: 40 / 25 N-m
Max Lock Torque	40 N-m (350 in.lbs.)
Dimensions (L x W x H)	w/BL1830B / BL1850B / BL1860B: 164 x 81 x 248 mm
Net weight	1.4 - 1.7 kg (3.1 - 3.7 lbs.)

18V



LXT BL XPT

Belt Clip, (+/-) Bit, Battery, Charger, Z: Battery and Charger are sold separately

**DHP453RFX4 / RYE**  
13mm (1/2") Cordless Hammer Driver Drill

Extremely compact tool size

Li-ion Ah 6.0 5.0 3.0 1.5



Capacity	Steel: 13 mm (1/2") Wood: 36 mm (1-7/16") Masonry: 13 mm (1/2")
Impacts Per Minute (IPM)	High: 0-19,500 Low: 0-6,000
No Load Speed (RPM)	High: 0-1,300 Low: 0-400
Max Fastening Torque	Hard / Soft: 42 / 27 N-m
Max lock torque	38 N-m (340 in.lbs.)
Dimensions (L x W x H)	240x79x244mm (9-7/16"x3-1/8"x9-5/8")
Net weight	1.7kg (3.7lbs)

18V



4

Fast Charger, Battery, (+/-) Bit, Z: Battery and Charger are sold separately

**HP332DSAE / DZ** 10mm (3/8") Cordless Hammer Driver Drill

Compact and Ergonomic Design at Only 193 mm Long

Li-ion Ah 5.0 4.0 2.0 1.5



Capacity	Steel: 10mm (3/8") Wood: 28mm (1-1/8") Masonry: 8mm (5/16")
Chuck capacity	0.8 - 10 mm (1/32 - 3/8")
Impacts Per Minute (IPM)	High: 0 - 22,500 Low: 0 - 6,750
No Load Speed (RPM)	High: 0 - 1,500 Low: 0 - 450
Max Fastening Torque	Hard: 35 N-m Soft: 21 N-m
Max Lock Torque	32 N-m (280 in.lbs.)
Dimensions (L x W x H)	168x66x217mm (6-5/8"x2-5/8"x8-1/2")
Net Weight	1.1 - 1.3 kg (2.4 - 2.8 lbs)

12Vmax



CXT BL XPT

Battery, Charger, Battery cover, Belt clip, Phillips bit, DZ: Battery and Charger are sold separately

**HP333DSAE / DWYE / DYEX4 / DZ**  
10mm (3/8") Cordless Hammer Driver Drill

12Vmax CXT Li-Ion Cordless 10 mm (3/8") 28 N-m (250 in.lbs.)

Li-ion Ah 5.0 4.0 2.0 1.5



HP333DZ  
4  
HP333DSAE / DWYE  
2

Capacity	Steel / Wood / Masonry: 10 / 21 / 8 mm (3/8" / 13/16" / 5/16")
Impacts Per Minute (IPM)	High / Low: 0 - 25,500 / 0 - 6,750
No Load Speed (RPM)	High / Low: 0 - 1,700 / 0 - 450
Max Fastening Torque	Hard / Soft: 30 / 14 N-m
Max lock torque	28 N-m (250 in.lbs.)
Dimensions (L x W x H)	w/BL1016/BL1021B: 193x66x212 mm w/BL1041B: 193x66x229 mm
Net weight	1.1 - 1.3 kg (2.4 - 2.9 lbs.)

12Vmax



CXT

Phillips Bit, Belt Clip, Battery, Charger, DZ: Battery and Charger are sold separately

**HP330DWE** 10mm (3/8") Cordless Hammer Driver Drill

Hammer drill mode

Li-ion Ah 1.3



Capacity	Steel: 10 mm (3/8") Wood: 21 mm (13/16") Masonry: 8 mm (5/16")
Impacts Per Minute (IPM)	High: 0-22,500 Low: 0-6,000
No Load Speed (RPM)	High: 0-1,500 Low: 0-400
Max Fastening Torque	Hard / Soft: 24 / 12 N-m
Dimensions (L x W x H)	201x53x183mm (7-7/8"x2-1/16"x7-1/4")
Net Weight	1.1 kg (2.3lbs)

10.8V



2

Charger, Battery Cartridge, Phillips Bit, Holster, DZ: Battery and Charger are sold separately

**HP0300** 10mm (3/8") Hammer Driver Drill

10 mm (3/8") 320 W Hammer Driver Drill with Keyless Chuck

411



Continuous rating input	320W
Capacity	Concrete / Steel / Wood: 8 / 10 / 28mm (5/16" / 3/8" / 1-1/8")
Chuck Capacity	1.0 - 10 mm (1/32 - 3/8")
No Load Speed (RPM)	High / Low: 0 - 1,500 / 0 - 450
Blows Per Minute (BPM)	High / Low: 0 - 22,500 / 0 - 6,750
Max Fastening Torque	Hard / Soft: 56.0 / 21.0 N-m (500 / 190 in.lbs.)
Max lock torque	42.0 N-m (370 in.lbs.)
Dimensions (L x W x H)	235x67x206 mm (9-1/4"x2-5/8"x8-1/8")
Net weight	1.3 kg (2.8 lbs.)
Power supply cord	2.5 m (8.2 ft)

Bit



6

**HP1630** 16mm (5/8") Hammer Drill

High power 710W motor

85

110V  
HP1630/B



Continuous Rating Input	710W
Capacity	Concrete: 16 mm (5/8") Steel: 13 mm (1/2") Wood: 30 mm (1-3/16")
No Load Speed (RPM)	0 - 3,200
Impacts Per Minute (IPM)	0 - 48,000
Sound Power Level	108 dB(A)
Dimensions (L x W x H)	296x75x204mm (11-5/8"x2-15/16"x8")
Net Weight	2.1 kg (4.6 lbs)
Power Supply Cord	2.0 m (6.6 ft)

Side Grip, Chuck Key (HP1630)



6

**HP2050** 20mm (3/4") 2-Speed Hammer Drill

Slender and compact body with durable metal gear housing

419



Continuous Rating Input Capacity	720W Concrete: 20 mm (3/4") Steel Hi : 8mm (5/16") Steel Lo : 13mm (1/2") Wood Hi : 25mm (1") Wood Lo : 40mm (1-9/16")
Impacts Per Minute (IPM)	High: 0-58,000 Low: 0-24,000
No Load Speed (RPM)	High: 0-2,900 Low: 0-1,200
Overall Length	362 mm (14-1/4")
Net Weight	2.5kg (5.6lbs)
Power Supply Cord	2.5m (8.2ft)



Chuck Key, Side Grip, Depth Rod

**HP2070** 20mm (3/4") 2-Speed Hammer Drill

1,010W Power in slender and compact body with durable metal gear housing

419



Continuous Rating Input Capacity	1,010W Concrete: 20 mm (3/4") Steel High : 8mm (5/16") Steel Low : 16mm (5/8") Wood High : 25mm (1") Wood Low: 40mm (1-9/16")
Impacts Per Minute (IPM)	High: 0-58,000 Low: 0-24,000
No Load Speed (RPM)	High: 0-2,900 Low: 0-1,200
Overall Length	364 mm (14-3/8")
Net Weight	2.6kg (5.7lbs)
Power Supply Cord	2.5m (8.2ft)



Chuck Key, Side Grip, Depth Rod

# IMPACT DRIVER

## PRODUCTS



**TD001GM201 (RM2J) / GD201 (RD2J) / GZ**  
Cordless Impact Driver

High Power 220 N-m

Li-ion Ah 5.0 | 4.0 | 2.5 | 2.0



TD001GM201 / GD201 / GZ



Capacity- Machine screw	M4 - M8 (5/32" - 5/16")
Standard Bolt	M5 - M16 (3/16" - 5/8")
High Strength Bolt	M5 - M14 (3/16" - 9/16")
Coarse thread (in length):	22 - 125 mm (7/8" - 4-7/8")
Hex Shank	6.35 mm (1/4")
No Load Speed (RPM)	0 - 3,700 / 3,200 / 2,100 / 1,100
Impacts Per Minute (IPM)	0 - 4,400 / 3,600 / 2,600 / 1,100
Max Fastening Torque	220 N-m (1,950 in.lbs.)
Fastening Torque	Hard / Med / Soft: 170 / 50 / 20 N-m
Dimensions (L x W x H)	w/ BL4025: 120x86x245 mm w/ BL4040: 120x86x250 mm
Net weight	1.7 - 2.0 kg (3.7 - 4.4 lbs.)

40Vmax



Phillips Bit, Belt Clip, Battery, Charger, Z: Battery and Charger are sold separately

photo: TD002G

Max fastening torque

# 220 N·m

## Dual spring technology

Optimal impact blow suppresses increase in recoil and vibration, which occur after the tool starts impact blow.

**4-speed power selection**

**6 Assist modes**

**TD002GZ01** Cordless Impact Driver

New

Cordless Wood/Bolt/T-Mode 220 N-m (1,950 in.lbs.) Impact Driver

Li-ion Ah 8.0 | 5.0 | 4.0 | 2.5 | 2.0



Capacity- Machine screw	M4 - M8 (5/32" - 5/16")
Standard Bolt	M5 - M16 (3/16" - 5/8")
High Strength Bolt	M5 - M14 (3/16" - 9/16")
Coarse thread (in length):	22 - 125 mm (7/8" - 4-7/8")
Hex Shank	6.35 mm (1/4")
No Load Speed (RPM)	0 - 3,700 / 3,200 / 2,100 / 1,100 / 1,800 / 2,700 / 3,700
Impacts Per Minute (IPM)	0 - 4,600 / 3,600 / 2,600 / 1,400 / 4,600 / N/A / 4,600
Max Fastening Torque	220 N-m (1,950 in.lbs.)
Fastening Torque	Hard / Med / Soft: 170 / 50 / 20 N-m
Dimensions (L x W x H)	w/ BL4025: 119x86x247mm w/ BL4050F: 119x86x278mm
Net weight	1.7 - 2.9 kg (3.7 - 6.4 lbs.)

40Vmax



Belt clip, Battery, Charger, Z: Battery and Charger are sold separately

**Wood mode**

**Bolt mode**

**Teks screw**



**TD003GA201(SA2J) / GZ Cordless Impact Driver**

Max fastening torque: 210 N-m

Li-ion Ah 8.0 5.0 4.0 2.5 2.0



Capacity - Machine screw	M4 - M8 (5/32" - 5/16")
Standard Bolt	M5 - M16 (3/16" - 5/8")
High Tensile Bolt	M5 - M14 (3/16" - 9/16")
Coarse thread (in length):	22 - 125 mm (7/8" - 4-7/8")
Hex Shank	6.35 mm (1/4")
No Load Speed (RPM)	0 - 3,700 / 3,200 / 2,100 / 1,100 / 2,400
Impacts Per Minute (IPM)	0 - 4,100 / 3,600 / 2,600 / 1,400 / N/A
Max Fastening Torque	210 N-m (1,860 in.lbs.)
Fastening Torque	Hard / Med / Soft: 170 / 50 / 20 N-m
Dimensions (L x W x H)	w/BL4025: 121x86x245 mm
Net weight	w/BL4050F: 121x86x274 mm 1.7 - 2.9 kg (3.7 - 6.4 lbs.)

40Vmax



Belt clip, Battery, Charger, Z: Battery and Charger are sold separately

**DTD172RFJ / RTE / Z Cordless Impact Driver**

18V LXT BL Brushless Cordless Wood/Bolt/T-Mode 180 N-m Impact Driver

Li-ion Ah 6.0 5.0 3.0 1.5



Capacity - Machine screw	M4 - M8 (5/32" - 5/16")
Standard Bolt	M5 - M16 (3/16" - 5/8")
High Tensile Bolt	M5 - M14 (3/16" - 9/16")
Coarse thread (in length):	22 - 125 mm (7/8" - 4-7/8")
Hex Shank	6.35 mm (1/4")
No Load Speed (RPM)	0 - 3,600 / 3,200 / 2,100 / 1,100 / 1,800 / 3,600 / 2,900 / 3,600
Impacts Per Minute (IPM)	0 - 3,800 / 3,600 / 2,600 / 1,100 / 3,800 / 3,800 / N/A / 2,600
Max Fastening Torque	180 N-m (1,590 in.lbs.)
Dimension (L x W x H)	114 x 81 x 236 mm
Net weight	1.2 - 1.5 kg (2.7 - 3.5 lbs.)

18V



Phillips Bit, Belt Clip, Battery, Charger, Z: Battery and Charger are sold separately

**DTD154RTE / Z Cordless Impact Driver**

ULTRA-COMPACT and ergonomic design at only 117 mm long

Li-ion Ah 6.0 5.0 3.0 1.5



Capacity - Machine screw	M4 - M8 (5/32" - 5/16")
Standard Bolt	M5 - M16 (3/16" - 5/8")
High Tensile Bolt	M5 - M14 (3/16" - 9/16")
Coarse thread (in length):	22 - 125 mm (7/8" - 4-7/8")
Hex Shank	6.35 mm (1/4")
No Load Speed (RPM)	0 - 3,600 / 0 - 2,100 / 0 - 1,100
Impacts Per Minute (IPM)	0 - 3,800 / 0 - 2,600 / 0 - 1,100
Max Fastening Torque	175 N-m (1,550 in.lbs.)
Sound Power Level	107 dB(A)
Dimensions (L x W x H)	117 x 79 x 236 mm
Net weight	(4-5/8" x 3-1/8" x 9-1/4") 1.2 kg (2.7 lbs)

18V



Belt clip, Battery, Fast Charger, Z: Battery and Charger are sold separately



**DTD153RTE / Z Cordless Impact Driver**

High Performance with Brushless DC Motor

Li-ion Ah 6.0 5.0 3.0 1.5



Capacity - Machine screw	M4 - M8 (5/32" - 5/16")
Standard Bolt	M5 - M16 (3/16" - 5/8")
High Tensile Bolt	M5 - M14 (3/16" - 9/16")
Coarse thread (in length):	22 - 125 mm (7/8" - 4-7/8")
Hex Shank	6.35 mm (1/4")
No Load Speed (RPM)	0 - 3,400
Impacts Per Minute (IPM)	0 - 3,600
Max Fastening Torque	170 N-m (1,500 in.lbs.)
Sound Power Level	107 dB(A)
Dimensions (L x W x H)	126 x 79 x 238 mm
Net weight	(5" x 3-1/8" x 3-3/8") 1.3 kg (2.8 lbs)

18V



Fast Charger, Battery Cartridge, Z: Battery and Charger are sold separately

**DTD152RTE / RFE / Z Cordless Impact Driver**

Delivers 2,900 max RPM and 165 N-m (1,460 in.lbs.) of max torque

448 Wh

Li-ion Ah 6.0 5.0 3.0 1.5



Capacity - Machine screw	M4 - M8 (5/32" - 5/16")
Standard Bolt	M5 - M16 (3/16" - 5/8")
High Tensile Bolt	M5 - M12 (3/16" - 1/2")
Coarse thread (in length):	22 - 125 mm (7/8" - 4-7/8")
Hex Shank	6.35 mm (1/4")
No Load Speed (RPM)	0 - 2,900
Impacts Per Minute (IPM)	0 - 3,500
Max Fastening Torque	165 N-m (1,460 in.lbs.)
Sound Power Level	104 dB(A)
Dimensions (L x W x H)	137 x 79 x 238 mm
Net weight	(5-3/8" x 3-1/8" x 3-3/8") 1.3 kg (2.8 lbs)

18V



Belt clip, Battery, Fast Charger, Z: Battery and Charger are sold separately

**DTD156SYE / ZK Cordless Impact Driver**

18V LXT Li-Ion Cordless 155 N-m (1,370 in.lbs.) Impact Driver

5 Wh

Li-ion Ah 6.0 5.0 3.0 1.5



Capacity - Machine screw	M4 - M8 (5/32" - 5/16")
Standard Bolt	M5 - M14 (3/16" - 9/16")
High Tensile Bolt	M5 - M12 (3/16" - 1/2")
Coarse thread (in length):	22 - 125 mm (7/8" - 4-7/8")
Hex Shank	6.35 mm (1/4")
No Load Speed (RPM)	0 - 2,500
Impacts Per Minute (IPM)	0 - 3,000
Max Fastening Torque	155 N-m (1,370 in.lbs.)
Sound Power Level	103 dB(A)
Dimensions (L x W x H)	43 x 79 x 241 mm
Net weight	(5-5/8" x 3-1/8" x 9-1/2") 1.3 - 1.6 kg (2.9 - 3.6 lbs.)

18V



Belt Clip, Battery, Fast Charger Bit, Z: Battery and Charger are sold separately

**DTD157RTJ / Z Cordless Impact Driver**

Anti-bit wobbling structure

Li-ion Ah 6.0 5.0 3.0 1.5



Capacity - Machine screw	M4 - M8 mm (5/32" - 5/16")
Standard Bolt	M5 - M14 (3/16" - 9/16")
High Tensile Bolt	M5 - M12 (3/16" - 1/2")
Coarse thread (in length):	22 - 90 mm (7/8" - 3-1/2")
Hex Shank	6.35 mm (1/4")
No Load Speed (RPM)	Hard/Soft: 0-3,000 / 0-1,300
Impacts Per Minute (IPM)	Hard/Soft: 0-3,900 / 0-1,600
Max Fastening Torque	140 N-m (1,240 in.lbs.)
Dimensions (L x W x H)	133 x 81 x 232 mm
Net weight	(5-1/4" x 3-1/16" x 9-1/8") 1.2 - 1.5 kg (2.7 - 3.3 lbs.)

18V



Belt Clip, Battery, Fast Charger, Z: Battery and Charger are sold separately

## TD111DSA / DZ Cordless Impact Driver Drill

Ultra compact and slim design at only 135 mm (5-5/16") long

Li-ion Ah 5.0 4.0 2.0 1.5

TD111DSA  
2TD111DZ  
4

Capacity- Machine screw	M4 - M8 (5/32" - 5/16")
Standard Bolt	M5 - M14 (3/16" - 9/16")
High Tensile Bolt	M5 - M12 (3/16" - 1/2")
Coarse thread (in length):	22 - 90mm (7/8" - 3-1/2")
Hex Shank	6.35 mm (1/4")
No Load Speed (RPM)	High: 0 - 3,000 Low: 0 - 1,300
Impacts Per Minute (IPM)	High: 0 - 3,900 Low: 0 - 1,600
Max Fastening Torque	135 N-m (1,200 in.lbs.)
Dimensions (L x W x H)	135x66x210mm (5-5/16"x2-5/8"x8-1/4")
Net Weight	0.97 - 1.1kg (2.1 - 2.5lbs)

12Vmax



Battery, Charger, Belt Clip, Phillips Bit, DZ: Battery and Charger are sold separately

## TD110DSA / DWYE / DZ Cordless Impact Driver Drill

12Vmax CXT Li-Ion Cordless 110 N-m (970 in.lbs.) Impact Driver

Li-ion Ah 5.0 4.0 2.0 1.5

TD110DSA / DWYE  
4TD110DZ  
3

Capacity- Machine screw	M4 - M8mm (5/32" - 5/16")
Standard Bolt	M5 - M12 (3/16" - 1/2")
High Tensile Bolt	M5 - M10 (3/16" - 3/8")
Coarse thread (in length):	22 - 90mm (7/8" - 3-1/2")
Hex Shank	6.35 mm (1/4")
No Load Speed (RPM)	0 - 2,600
Impacts Per Minute (IPM)	0 - 3,500
Max Fastening Torque	110 N-m (970 in.lbs.)
Dimensions (L x W x H)	153x66x204mm (6"x2-5/8"x8-1/8")
Net Weight	1 - 1.2kg (2.3 - 2.6 lbs)

12Vmax

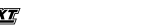

Battery, Charger, Battery cover, Belt clip, Phillips bit, DZ: Battery and Charger are sold separately

## TD090DWE Cordless Impact Driver

High operation efficiency with 10.8V Li-ion battery

Li-ion Ah 1.3



Capacity- Machine screw	M4 - M8 (5/32" - 5/16")
Standard Bolt	M5 - M12 (3/16" - 1/2")
High Tensile Bolt	M5 - M10 (3/16" - 3/8")
Coarse thread (in length):	22 - 90mm (7/8" - 3-1/2")
No Load Speed (RPM)	0 - 2,400
Impacts Per Minute (IPM)	0 - 3,000
Max Fastening Torque	90 N-m (800 in.lbs.)
Dimensions (L x W x H)	155x54x178mm (6-1/8"x2-1/8"x7")
Net Weight	0.92kg (2.0lbs)

10.8V



5

Battery Charger, Battery Cartridge, Holster

## TD022DSE Cordless Impact Driver

Compact and lightweight for easy handling

Li-ion Ah 1.5



Capacity- Machine screw	M3 - M8 (1/8" - 5/16")
Standard Bolt	M3 - M8 (1/8" - 5/16")
High Tensile Bolt	M3 - M6 (1/8" - 1/4")
Coarse thread (in length):	22 - 45mm (7/8" - 1-3/4")
Hex Shank	6.35 mm (1/4")
No Load Speed (RPM)	0 - 2,450
Impacts Per Minute (IPM)	0 - 3,000
Max Fastening Torque	25 N-m (220 in.lbs.)
Dimensions Straight Type (L x W x H)	282x42x52mm (11-1/8"x1-5/8"x2-1/16")
Dimensions Pistol Type (L x W x H)	227x42x142mm (8-15/16"x1-5/8"x5-5/8")
Net Weight	0.55 - 0.56 kg (1.2 lbs)

7.2V



4

Holster, Bit set, Battery, Charger

## DTS141Z Cordless Oil-Pulse Driver

18V LXT BL Brushless Cordless Oil-Pulse Driver

Li-ion Ah 6.0 5.0 3.0 1.5

DTS141RTE  
4

Capacity - Machine screw	M4 - M8 (5/32" - 5/16")
Standard Bolt	M5 - M8 (3/16 - 5/16")
High Strength Bolt	M5 - M6 (3/16 - 1/4")
Coarse thread (in length):	22 - 125 mm (7/8" - 4-7/8")
No Load Speed (RPM)	0 - 3,200/0 - 2,000/0 - 1,200
Impacts Per Minute (IPM)	0 - 2,700/0 - 2,200/0 - 1,400
Max Fastening Torque	40 N-m (355 in.lbs.)
Dimensions (L x W x H)	136 x 79 x 240 mm (5-3/8 x 3-1/8 x 9-1/2")
Net weight	1.3 - 1.6 kg (2.8 - 3.5 lbs.)

18V



Charger, Battery, Z: Battery and Charger are sold separately

## TD0101F Impact Driver

Compact design for perfect handling

411



Continuous Rating Input	230W
Capacity- Machine screw	M4 - M8 (5/32" - 5/16")
Standard Bolt	M5 - M14 (3/16" - 9/16")
High Tensile Bolt	M5 - M10 (3/16" - 3/8")
Coarse thread (in length):	22 - 90mm (7/8" - 3-1/2")
Driving Shank (Hex)	6.35mm (1/4")
Impacts Per Minute (IPM)	0 - 3,200
No Load Speed (RPM)	0 - 3,600
Max Fastening Torque	100 N-m (74 ft.lbs.)
Dimensions (L x W x H)	184x67x192mm (7-1/4"x2-5/8"x7-9/16")
Net Weight	0.99kg (2.2lbs)
Power Supply Cord	2.5m (8.2ft)



Phillips Bit

## DTL061Z Cordless Angle Impact Driver

Compact angle head for easy access in tight places

Li-ion Ah 6.0 5.0 3.0 1.5



Capacity - Machine screw	M4 - M8 (5/32" - 5/16")
Standard Bolt	M4 - M12 (5/32" - 1/2")
High Tensile Bolt	M4 - M8 (5/32" - 5/16")
Coarse thread (in length):	22 - 75 mm (7/8" - 2-31/32")
Hex Shank	6.35 mm (1/4")
No Load Speed (RPM)	0 - 2,000
Impacts Per Minute (IPM)	0 - 3,000
Max Fastening Torque	60 N-m (530 in.lbs.)
Dimensions (L x W x H)	387x78x116 mm (15-1/4"x3-1/16"x4-9/16")
Net weight	1.4 - 2.0 kg (3.1 - 4.3 lbs)

18V



5

Z: Battery and Charger are sold separately

## TL064DZ Cordless Angle Impact Driver

12Vmax CXT Li-Ion Cordless 60 N-m (530 in.lbs.) Angle Impact Driver

Li-ion Ah 5.0 4.0 2.0 1.5



Capacity	Machine Screw: M4 - M8 (5/32" - 5/16") Standard Bolt: M4 - M12 (5/32" - 1/2") High Tensile Bolt: M4 - M8 (5/32" - 5/16") Coarse thread (in length): 22 - 75 mm (7/8" - 2-31/32")
Hex Shank	6.35 mm (1/4")
No Load Speed (RPM)	0 - 2,000
Impacts Per Minute (IPM)	0 - 3,000
Max Fastening Torque	60 N-m (530 in.lbs.)
Dimensions (L x W x H)	361x66x86 mm (14-1/4"x2-5/8"x3-3/8")
Net Weight	1.2 - 1.6 kg (2.7 - 3.6 lbs)

12Vmax



5

Phillips Bit, Belt Clip, Battery, Charger, DZ: Battery and Charger are sold separately



# IMPACT WRENCH

## PRODUCTS



### TW001GM204(RM2JX) / GD203(RD2JX) / GZ 19mm (3/4") Cordless Impact Wrench

Over 2,000 N-m of nut-busting torque

Li-ion Ah 5.0 4.0 2.5 2.0



TW001GZ  
4  
TW001GM204/  
GM203  
1

<b>Fastening Capacities</b>	Standard Bolt: M12 - M36 (1/2" - 1-7/16") High Strength Bolt: M10 - M27 (3/8" - 1-1/16")
<b>Square Drive</b>	19 mm (3/4")
<b>No Load Speed (RPM)</b>	Max / Hard / Med / Soft: 0 - 1,800 / 0 - 1,400 / 0 - 1,150 / 0 - 950
<b>Impacts Per Minute (IPM)</b>	Max / Hard / Med / Soft: 0 - 2,500 / 0 - 2,400 / 0 - 2,200 / 0 - 1,900
<b>Max Fastening Torque</b>	1,800 N-m (1,330 ft.lbs.)
<b>Dimensions (L x W x H)</b>	w/ BL4025: 217x94x297 mm w/ BL4040: 217x94x303 mm
<b>Net weight</b>	3.9 - 4.2 kg (8.6 - 9.3 lbs.)

40Vmax



Belt Clip, Battery, Charger, Z: Battery and Charger are sold separately

### TW007GM201(RM2J) / GZ 12.7mm (1/2") Cordless Impact Wrench

Increased torque 730 N-m (540 ft.lbs.)

Li-ion Ah 5.0 4.0 2.5 2.0



1

<b>Fastening Capacities</b>	Standard Bolt: M10 - M24 (3/8" - 1") High Strength Bolt (Grade 10.9): M10 - M16 (3/8" - 5/8") High Strength Bolt (Grade F10T): M12, M16 (7/16, 5/8")
<b>Square Drive</b>	12.7 mm (1/2")
<b>No Load Speed (RPM)</b>	Max / Hard / Mid / Soft: 0 - 2,300 / 1,900 / 1,200 / 600
<b>Impacts Per Minute (IPM)</b>	Max / Hard / Mid / Soft: 0 - 2,900 / 2,700 / 1,900 / 1,200
<b>Max Fastening Torque</b>	730 N-m (540 ft.lbs.)
<b>Dimensions (L x W x H)</b>	w/ BL4025: 170 x 86 x 285 mm
<b>Net weight</b>	2.7 - 3.3 kg (6.0 - 7.3 lbs.)

40Vmax



Belt Clip, Battery, Charger, Z: Battery and Charger are sold separately

### TW004GD201(RD2J) / GZ 12.7mm (1/2") Cordless Impact Wrench

Increased motor speed under load delivers higher torque

Li-ion Ah 5.0 4.0 2.5 2.0



TW004GZ  
4  
TW004GD201  
1

<b>Fastening Capacities</b>	Standard Bolt: M10 - M20 (3/8" - 3/4") High Strength Bolt: M10 - M16 (3/8" - 5/8")
<b>Square Drive</b>	12.7 mm (1/2")
<b>No Load Speed (RPM)</b>	Max / Hard / Med / Soft: 0 - 3,200 / 2,600 / 1,800 / 1,000
<b>Impacts Per Minute (IPM)</b>	Max / Hard / Med / Soft: 0 - 4,000 / 3,400 / 2,600 / 1,800
<b>Max Fastening Torque</b>	350 N-m (260 ft.lbs.)
<b>Dimensions (L x W x H)</b>	w/ BL4025: 144 x 86 x 248 mm w/ BL4040: 144 x 86 x 253 mm
<b>Net weight</b>	1.9 - 2.2 kg (4.2 - 4.9 lbs.)

40Vmax



Belt Clip, Battery, Charger, Z: Battery and Charger are sold separately

### DTW1001JX2 / Z 19mm (3/4") Cordless Impact Wrench

Electronic 3 stage impact power selection reduces fault tightening

Li-ion Ah 6.0 5.0 3.0 1.5



<b>Fastening Capacities</b>	Standard Bolt: M12 - M30 (1/2" - 1-1/4") High Tensile Bolt: M10 - M24 (3/8" - 1")
<b>Square Drive</b>	19 mm (3/4")
<b>No Load Speed (RPM)</b>	Hard / Medium / Soft: 0 - 1,800 / 0 - 1,000 / 0 - 900
<b>Impacts Per Minute (IPM)</b>	Hard / Medium / Soft: 0 - 2,200 / 0 - 2,000 / 0 - 1,800
<b>Max Fastening Torque</b>	1,050 N-m (780 ft.lbs.)
<b>Sound Power Level</b>	109 dB(A)
<b>Dimensions</b>	229x91x289mm (L x W x H)
<b>Net weight</b>	3.4kg (7.6 lbs)

18V



Fast charger, Battery cartridge (Tool does not come with socket), Z: Battery and Charger are sold separately

### DTW1002JX2 / Z 12.7mm (1/2") Cordless Impact Wrench

Most POWERFUL 1,200 N-m (890 ft.lbs.) 1/2" Impact Wrench

Li-ion Ah 6.0 5.0 3.0 1.5



DTW1002Z  
4

<b>Fastening Capacities</b>	Standard Bolt: M12 - M30 (1/2" - 1-1/4") High Tensile Bolt: M10 - M24 (3/8" - 1")
<b>Square Drive</b>	12.7 mm (1/2")
<b>No Load Speed (RPM)</b>	Hard / Medium / Soft: 0 - 1,800 / 0 - 1,000 / 0 - 900
<b>Impacts Per Minute (IPM)</b>	Hard / Medium / Soft: 0 - 2,200 / 0 - 2,000 / 0 - 1,800
<b>Max Fastening Torque</b>	1,200 N-m (890 ft.lbs.)
<b>Sound Power Level</b>	108 dB(A)
<b>Dimensions</b>	229x91x289mm (L x W x H)
<b>Net weight</b>	3.3kg (7.3 lbs)

18V



Fast charger, Battery cartridge (Tool does not come with socket), Z: Battery and Charger are sold separately

### DTW800RMJ 11.1mm (7/16") Cordless Impact Wrench

Cordless 3-Speed 7/16" (11.2mm) 800 N-m (590 ft.lbs.) Impact Wrench

Li-ion Ah 6.0 5.0 3.0 1.5



4

<b>Fastening Capacities</b>	Standard Bolt: M12 - M24 (1/2" - 1") High Tensile Bolt: M10 - M22 (3/8" - 7/8")
<b>Hex Shank</b>	11.1 mm (7/16")
<b>No Load Speed (RPM)</b>	Hard / Medium / Soft: 0 - 1,800 / 0 - 1,000 / 0 - 900
<b>Impacts Per Minute (IPM)</b>	Hard / Medium / Soft: 0 - 2,200 / 0 - 2,000 / 0 - 1,800
<b>Max Fastening Torque</b>	800 N-m (590 ft.lbs.)
<b>Sound Power Level</b>	106 dB(A)
<b>Dimensions</b>	229x91x303mm (L x W x H)
<b>Net weight</b>	3.4kg (7.6 lbs)

18V



Fast charger, Battery cartridge (Tool does not come with socket), Z: Battery and Charger are sold separately

## DTW700RTJ / Z 12.7mm (1/2") Cordless Impact Wrench

BL motor delivers 700 N-m (520 ft.lbs.) of max torque

Li-ion Ah 6.0 5.0 3.0 1.5



DTW700RTJ

1

4

Fastening Capacities	Standard Bolt:	M10 - M24 (3/8" - 1")
	High Strength Bolt:	M10 - M16 (3/8" - 5/8")
Square Drive		12.7 mm (1/2")
No Load Speed (RPM)	Max / Hard / Mid / Soft:	0 - 2,200 / 1,900 / 1,200 / 500
Impacts Per Minute (IPM)	Max / Hard / Mid / Soft:	0 - 2,700 / 2,400 / 1,700 / 1,000
	Max Fastening Torque	700 N-m (520 ft.lbs.)
Dimensions (L x W x H)	w/ BL1830B / BL1850B / BL1860B:	170x81x276 mm (6-11/16"x3-3/16"x10-7/8")
	Net weight	2.3 - 2.7 kg (5.1 - 6.0 lbs.)

18V



LXT BL XPT

Belt Clip, Battery, Charger, Z: Battery and Charger are sold separately

## DTW450RTE / Z 12.7mm (1/2") Cordless Impact Wrench

Maximum fastening torque of 440N.m (3,900in.lbs)

441

Li-ion Ah 6.0 5.0 3.0 1.5



DTW450Z

5

1

Fastening Capacities	Standard Bolt:	M12 - M22 (1/2" - 7/8")
	High Tensile Bolt:	M12 - M16 (1/2" - 5/8")
Square Drive		12.7 mm (1/2")
No Load Speed (RPM)		1,600
Impacts Per Minute (IPM)		2,200
Max Fastening Torque		440 N-m (325 ft.lbs.)
Sound Power Level		105 dB(A)
Dimensions (L x W x H)		266x82x290mm
	Net weight	3.4kg (7.5lbs)

18V



Fast Charger, Battery Cartridge, Z: Battery and Charger are sold separately (Tool does not come with socket)

## DTW300RTJ / RFJ / Z 12.7mm (1/2") Cordless Impact Wrench

BL motor delivers 330 N-m (240 ft.lbs.) of max torque

Li-ion Ah 6.0 5.0 3.0 1.5



DTW300RTJ

1

Fastening Capacities	Standard Bolt:	M10 - M20 (3/8" - 3/4")
	High Strength Bolt:	M10 - M16 (3/8" - 5/8")
Square Drive		12.7 mm (1/2")
No Load Speed (RPM)	Max / Hard / Mid / Soft:	0 - 3,200 / 0 - 2,600 / 0 - 1,800 / 0 - 1,000
Impacts Per Minute (IPM)	Max / Hard / Mid / Soft:	0 - 4,000 / 0 - 3,400 / 0 - 2,600 / 0 - 1,800
	Max Fastening Torque	330 N-m (240 ft.lbs.)
Dimensions (L x W x H)	w/ BL1830B / BL1850B / BL1860B:	144x81x246 mm (5-5/8"x3-3/16"x9-11/16")
	Net weight	1.5 - 1.8 kg (3.4 - 4.1 lbs.)

18V



LXT BL XPT

Belt Clip, Battery, Charger, Z: Battery and Charger are sold separately

## DTW251RTE / Z 12.7mm (1/2") Cordless Impact Wrench

High torque to weight ratio at 230N.m (2,040in.lbs)

448

Li-ion Ah 6.0 5.0 3.0 1.5



4

Fastening Capacities	Standard Bolt:	M10 - M16 (3/8" - 5/8")
	High Tensile Bolt:	M10 - M14 (3/8" - 9/16")
Square Drive		12.7 mm (1/2")
No Load Speed (RPM)		0 - 2,100
Impacts Per Minute (IPM)		0 - 3,200
Max Fastening Torque		230 N-m (170 ft.lbs.)
Sound Power Level		105 dB(A)
Dimensions (L x W x H)		165x79x234mm
	Net weight	1.5kg (3.3lbs)

18V



Fast Charger, Battery Cartridge, Z: Battery and Charger are sold separately (Tool does not come with socket)

## DTW190RFE / Z 12.7mm (1/2") Cordless Impact Wrench

190 N-m (140 ft.lbs.) of Max torque optimal for scaffold building

Li-ion Ah 6.0 5.0 3.0 1.5



2

Fastening Capacities	Standard Bolt:	M8 - M16 (5/16" - 5/8")
	High Tensile Bolt:	M8 - M12 (5/16" - 1/2")
Square Drive		12.7 mm (1/2")
No Load Speed (RPM)		0 - 2,300
Impacts Per Minute (IPM)		0 - 3,000
Max Fastening Torque		190 N-m (140 ft.lbs.)
Sound Power Level		105 dB(A)
Overall Length		176 mm (6-15/16")
Net weight		1.4 kg (3.2 lbs)

18V



Fast Charger, Battery Cartridge, Z: Battery and Charger are sold separately

## TW0200 12.7mm (1/2") Impact Wrench

Aluminum hammer case with high durability (200N.m [150ft.lbs])

411



5

Continuous Rating Input	380W	
Fastening Capacities	Standard Bolt:	M10 - M16 (3/8" - 5/8")
	High Tensile Bolt:	M10 - M12 (3/8" - 1/2")
Square Drive		12.7 mm (1/2")
No Load Speed (RPM)		0 - 2,200
Impacts Per Minute (IPM)		0 - 2,200
Max Fastening Torque		200 N-m (150 ft.lbs.)
Sound Power Level		104 dB(A)
Dimensions (L x W x H)		251 x 72 x 220mm
	Net Weight	2.1kg (4.7lbs)
Power Supply Cord		2.5m (8.2ft)

Socket (24mm)

## TW0350 12.7mm (1/2") Impact Wrench

Incredibly high torque of 350N.m (260ft.lbs)

411

110V

TW0350/B



4

Continuous Rating Input	400W	
Fastening Capacities	Standard Bolt:	M12 - M22 (1/2" - 7/8")
	High Tensile Bolt:	M12 - M16 (1/2" - 5/8")
Square Drive		12.7 mm (1/2")
No Load Speed (RPM)		2,000
Impacts Per Minute (IPM)		2,000
Max Fastening Torque		350 N-m (260 ft.lbs.)
Sound Power Level		104 dB(A)
Dimensions (L x W x H)		283x87x233mm
	Net Weight	3.0kg (6.6lbs)
Power Supply Cord		2.5m (8.2ft)



Socket

## 6906 19mm (3/4") Impact Wrench

Powerful torque of 588N.m(441ft.lbs) for super-duty applications

100



1

Continuous Rating Input	850W	
Capacity	Standard Bolt:	M16 - M22 (5/8" - 7/8")
	High Tensile Bolt:	M16 - M20 (5/8" - 3/4")
Square Drive		19 mm (3/4")
No Load Speed (RPM)		1,700
Impacts Per Minute (IPM)		1,600
Max Fastening Torque		588 N-m (441 ft.lbs.)
Sound Power Level		109 dB(A)
Overall Length		327 mm (12-7/8")
Net Weight		5.6kg (12.3lbs)
Power Supply Cord		2.5m (8.2ft)

Side Grip, Socket



**TW1000 25.4mm (1") Impact Wrench**

Huge 1,000 N-m (738 ft.lbs.) of Power for Industrial Applications



**110V**  
**TW1000/B**



Continuous Rating Input	1,200W
Fastening Capacities	Standard Bolt: M24-M30(15/16"-1-3/16")
	High Tensile Bolt: M22-M24(7/8"-15/16")
	Square Drive 25.4 mm (1")
No Load Speed (RPM)	1,400
Impacts Per Minute (IPM)	1,500
Max Fastening Torque	1,000 N-m (738 ft.lbs.)
Sound Power Level	114 dB(A)
Dimensions (L x W x H)	382x110x290mm (15"x4-5/16"x11-3/8")
Net Weight	8.8kg (19.4lbs)
Power Supply Cord	2.5m (8.2ft)



Socket 41-80, Side Grip

**DWR180RF / Z**

9.5mm / 6.35mm (3/8 / 1/4") Cordless Ratchet Wrench

18V LXT Li-Ion Cordless 47.5 N-m (420 in.lbs.) Ratchet Wrench

Li-ion Ah 6.0 | 5.0 | 3.0 | 1.5



Capacity	Standard Bolt: M5 - M12 (3/16 - 1/2")
	High Strength Bolt: M5 - M10 (3/16 - 3/8")
	Square Drive 9.5 / 6.35 mm (3/8 / 1/4")
No Load Speed (RPM)	0 - 800
Max Fastening Torque	47.5 N-m (420 in.lbs.)
Dimensions (L x W x H)	w/ BL1830B / BL1850B / BL1860B: 369 x 79 x 87 mm (14-1/2 x 3-1/8 x 3-7/16")
Net weight	1.2 - 1.6 kg (2.6 - 3.5 lbs.)

18V



6

Socket Adapter, Battery, Charger, Tool Bag, Z: Battery and Charger are sold separately

**WR100DSAOK / DZ**

9.5mm / 6.35mm (3/8 / 1/4") Cordless Ratchet Wrench

Compatible with variable sockets with socket adapter

Li-ion Ah 5.0 | 4.0 | 2.0 | 1.5



WR100DSAOK



Capacity	Standard Bolt: M5 - M12 (3/16" - 1/2")
	High Tensile Bolt: M5 - M10 (3/16" - 3/8")
	Square Drive 9.5 / 6.35 mm (3/8" / 1/4")
No Load Speed (RPM)	0 - 800
Max Fastening Torque	47.5 N-m (420 in.lbs.)
Dimensions (L x W x H)	w/ BL1016/BL1021B: 341x67x63 mm (13-7/16"x2-5/8"x2-1/2") w/ BL1041B: 341x67x84 mm (13-7/16"x2-5/8"x3-5/16")
Net weight	1.0 - 1.2 kg (2.3 - 2.7 lbs.)

12Vmax



Socket Adapter, Battery, Charger, Tool Bag, DZ: Battery and Charger are sold separately

**DTL063Z 9.5mm (3/8") Cordless Angle Impact Wrench**

Compact angle head for easy access to bolts in tight places

Li-ion Ah 6.0 | 5.0 | 3.0 | 1.5



Fastening Capacities	Standard Bolt: M4 - M12 (5/32" - 1/2")
	High Tensile Bolt: M4 - M8 (5/32" - 5/16")
	Square Drive 9.5 mm (3/8")
No Load Speed (RPM)	0 - 2,000
Impacts Per Minute (IPM)	0 - 3,000
Max Fastening Torque	60 N-m
Sound Power Level	99 dB(A)
Dimensions (L x W x H)	387x78x116 mm (15-1/4"x3-1/16"x4-9/16")
Net weight	1.4 - 2.0 kg (3.1 - 4.3 lbs.)

18V



5

Z: Battery and Charger are sold separately

**Lightweight design**



**XPT**

**Higher maneuverability**

photo: WT001G

Max. Torque shear bolt capacity  
**M22**

- High strength torque shear bolt (HTB): **M16, M20, M22**
- Super high strength torque shear bolt (SHTB): **M16, M20**
- A325 Torque shear bolt: **5/8, 3/4, 7/8"**
- A490 Torque shear bolt: **5/8, 3/4"**

Battery capacity warning lamp



**BL MOTOR**  
High power with BL motor

WT001G

\* **5.5 kg**  
battery: BL4040  
\* Without Sleeve



Predecessor Model  
\* **7.1 kg**  
battery: BL1860Bx2

Hook designed for use with shoulder belt to carry the tool  
Shoulder belt (for transportation)



Bolt-tip ejection lever

enables easy ejection of removed bolt-tip left in the socket of the machine.



**Large work amount**

Fastening capacity of M22 Torque shear bolt: Battery: BL4025 **Approx. 150 pcs**  
Battery: BL4040 **Approx. 250 pcs**

**WT001GZ** Cordless Shear Wrench

New

40Vmax XGT BL Brushless Cordless 804 N-m (593 ft.lbs.) Shear Wrench

Li-ion Ah 8.0 | 5.0 | 4.0 | 2.5 | 2.0



Capacity	High strength torque shear bolt (HTB): M16, M20, M22 (5/8, 3/4, 7/8")
No Load Speed (RPM)	17 min <sup>-1</sup>
Max Fastening Torque	804 N-m (593 ft.lbs.)
Sound Power Level	82 dB(A)
Dimensions (L x W x H)	w/ M22 Sleeve, w/ BL4040: 270 x 95 x 340 mm (10-5/8 x 3-3/4 x 13-3/8")
Net weight	5.2 - 5.9 kg (11.5 - 13 lbs.)

40Vmax



Screwdriver, Shoulder belt, Outer sleeve, Inner sleeve, Battery, Charger, Z: Battery and Charger are sold separately

**DWT310ZK** Cordless Shear Wrench

High-speed fastening beyond AC tool

Li-ion Ah 6.0 | 5.0 | 3.0 | 1.5



Capacity	Bolt: M16, M20, M22 (5/8" 3/4" 7/8")
No Load Speed (RPM)	14
Max Fastening Torque	804 N-m (593 ft.lbs.)
Sound Power Level	94 dB(A)
Dimensions (L x W x H)	296x130x377 mm (11-5/8"x5-1/8"x14-7/8")
Net weight	6.5 - 7.1 kg (14.3 - 15.7 lbs.)

18V x2



1

Screwdriver, Battery, Fast Charger, Z: Battery and Charger are sold separately

# SCREW-DRIVER

## PRODUCTS



**FS2500** Screwdriver

Best possible tool body for screwdriving

419



Continuous Rating Input	570W
Capacity	Drywall screw: 5mm (3/16") Self-Drilling Screw: 6mm (1/4")
Driving Shank (Hex)	6.35mm (1/4")
No Load Speed (RPM)	0-2,500
Sound Power Level	94 dB(A)
Dimensions (L x W x H)	280x70x207mm (11"x2-3/4"x8-1/8")
Net Weight	1.5kg (3.3lbs)
Power Supply Cord	2.5m (8.2ft)

Dimensions: for countries providing noise suppressor



Magnetic Socket Bit

**FS2700** Screwdriver

6 Stage torque adjustment for a wide range of applications

419



Continuous Rating Input	570W
Capacity	Machine screw: 8mm (5/16") Wood screw: 6.2mm (1/4") Self-Drilling Screw: 6mm (1/4")
Driving Shank (Hex)	6.35mm (1/4")
No Load Speed (RPM)	0-2,500
Sound Power Level	94 dB(A)
Dimensions (L x W x H)	301x70x207mm (11-7/8"x2-3/4"x8-1/8")
Net Weight	1.8kg (4.0lbs)
Power Supply Cord	2.5m (8.2ft)

Dimensions: for countries providing noise suppressor



Phillip Insert Bit



**FS4300** Drywall Screwdriver

Silent clutch for quiet operation

419



Continuous Rating Input	570W
Capacity	Drywall screw: 5mm (3/16") Self-Drilling Screw: 6mm (1/4")
Driving Shank (Hex)	6.35mm (1/4")
No Load Speed (RPM)	0-4,000
Sound Power Level	93 dB(A)
Dimensions (L x W x H)	279x65x207mm (11"x2-9/16"x8-1/8")
Net Weight	1.4kg (3.1lbs)
Power Supply Cord	2.5m (8.2ft)

Dimensions: for countries providing noise suppressor and connect bit 60



Phillips Insert Bit (2pcs.), Magnetic Bit Holder



# MIXER

## PRODUCTS



**XGT**  
**40Vmax**  
Li-ion

Photo: UT001G

**Heavy duty operation such as mixing concrete**

Maximum Blade Diameter  
**240 mm**



**BL MOTOR**

Low speed  
**0-500 min<sup>-1</sup>**

High speed  
**0-920 min<sup>-1</sup>**

**Mechanical 2-speed gearing**  
**+**  
**Variable speed control by dial**



### UT001GZ Cordless Mixer

40Vmax XGT BL Cordless 240 mm (9-1/2") Variable 2-Speed Mixer

Li-ion Ah 8.0 | 5.0 | 4.0 | 2.5 | 2.0

Blade Diameter	240 mm (9-1/2")
No Load Speed (RPM)	High / Low: 0 - 920 / 0 - 500
Max Output	1,200 W
Dimensions (L x W x H)	w/ Cover S, w/ BL4020 / BL4025 / BL4040: 373 x 458 x 235 mm (14-3/4 x 18 x 9-1/4")
Net Weight	5.7 - 7.0 kg (12.6 - 15.4 lbs.)



40Vmax



Mixing blade, Battery, Charger, Z: Battery and Charger are sold separately

### DUT130Z Cordless Mixer

Variable 2-Speed Mixer

Li-ion Ah 6.0 | 5.0 | 3.0 | 1.5

Blade Diameter	165 mm (6-1/2")
No Load Speed (RPM)	High / Low: 0 - 1,300 / 0 - 350
Shank Size Of Tool Holder Portion	M12 or M14
Dimensions (L x W x H)	w/ Mixing Blade: 916x89x231 mm (36"x3-1/2"x9-1/8") w/o Mixing Blade: 320x89x231 mm (12-5/8"x3-1/2"x9-1/8")
Net Weight	2.6kg (5.7lbs) 2.5 - 2.8 kg (5.6 - 6.3 lbs.)



18V



Mixing Blade, Shaft, Grip, Front Cover, Wrenches, Battery, Charger, Z: Battery and Charger are sold separately

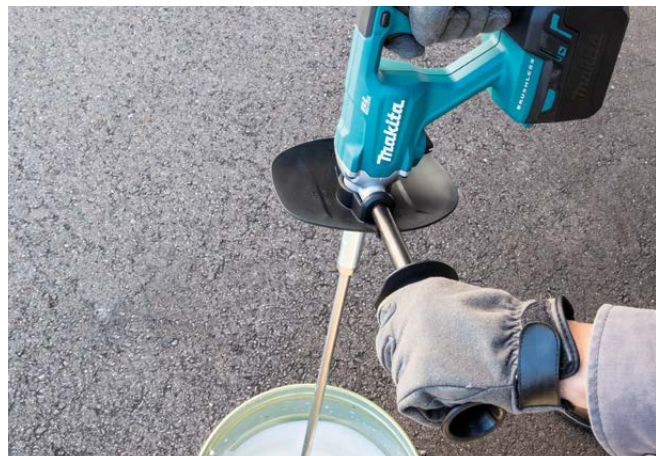

## UT1301 Power Mixer

Ideal for stirring of resin, paints and adhesives at high speeds

106

Continuous Rating Input	700W
Blade Diameter	130 mm (5-1/8")
No Load Speed (RPM)	1,300
Overall Length	820 mm (32-1/4")
Net Weight	3.6 kg (7.9 lbs)
Power Supply Cord	2.5 m (8.2 ft)



3

Mixing Blade, Hex Wrench, Wrench

## UT1305 Mixer

850W Heavy duty and high speed mixer

303

110V  
UT1305/B

Continuous Rating Input	850W
Blade Diameter	165 mm (6-1/2")
No Load Speed (RPM)	1,300
Shank Size Of Tool	M12
Holder Portion	
Dimensions (L x W x H)	942x87x152mm (37"x3-7/16"x6")
Net Weight	2.6kg (5.7lbs)
Power Supply Cord	2.5m (8.2ft)



1

Wrenches, Side Grip, Mixing Blade, Shaft

## STATIONARY DRILL

## PRODUCTS



## HB500 50mm (2") Magnetic Drill

Heavy duty Magnetic Drill

EIB106C

110V  
HB500/B

Capacity	Steel: 50 mm (2")
Chuck Capacity	16mm (5/8")
No Load Speed (RPM)	350 / 650
Magnetic Clamping Force	Minimum 9,300N (950kg)
Dimensions (L x W x H)	290x150x450mm (11-3/8"x5-7/8"x17-3/4")
Net Weight	18.5kg



1

Quick release arbor, Small oil cup assembly and clip, Safety guard, Polyester safety strap, Integral oil feed steady allen keys

## HB350 35mm (1-3/8") Magnetic Drill

Compact and lightweight for easy transport

UD00EBD002

Continuous Rating Input	1,050W
Capacity	Steel: 35 mm (1-3/8")
No Load Speed (RPM)	850
Magnetic Clamping Force	8,000 N
Dimensions (L x W x H)	270 x 110 x 330 mm
Net Weight	11.5 kg



1

Small oil cup assembly and clip, Safety guard, Polyester safety strap, Allen keys

## TB131 13mm (1/2") Drilling Machine 13mm

Compact drilling machine

Continuous rating input	250W
Capacity	Steel: 13mm (1/2") Wood: 24mm (15/16")
No Load Speed (RPM)	570, 890, 1,300, 1,900, 2,670 (50Hz), 690, 1,070, 1,560, 2,280, 3,200 (60Hz)
Net weight	20kg (44lbs)
Power supply cord	1.75m (5.7ft)



1

Chuck Key, Wrench





# ROTARY HAMMER

## PRODUCTS



### HR006GZ(K) 52mm (2-1/16") Cordless Rotary Hammer

Powerful BL motor delivers 20 J of impact energy

Li-ion Ah 8.0 | 5.0 | 4.0 | 2.5 | 2.0



Impact Energy	EPTA-Procedure 05/2009: 21.4 J
Capacity	Concrete (w/ TCT Bit): 52 mm
Blows Per Minute (BPM)	1,100 - 2,250
No Load Speed (RPM)	150 - 310
Max Output	2,600 W
Dimensions (L x W x H)	w/ BL4040: 610 x 140 x 337 mm (24 x 5-1/2 x 13-1/4")
Net weight	12.9 - 14.3 kg (28.4 - 31.5 lbs.)

40Vmax x2



Side Handle, Side Grip, Depth Gauge, Grease vessel, Z: Battery and Charger are sold separately

### HR005GM201(RM2K) / GZ(K) 40mm (1-9/16") Cordless Rotary Hammer

8.0 Joules (EPTA) Impact Energy Delivers High Performance

Li-ion Ah 8.0 | 5.0 | 4.0 | 2.5 | 2.0



Impact Energy	EPTA-Procedure 05/2009: 8 J
Capacity	Concrete (w/ TCT Bit): 40 mm
Blows Per Minute (BPM)	1,450 - 2,900
No Load Speed (RPM)	250 - 500
Sound Power Level	102 dB(A)
Vibration Level	Hammer Drilling into Concrete: 5.0 m/s <sup>2</sup>
Dimensions (L x W x H)	w/ BL4025: 484 x 115 x 286 mm w/ BL4040: 500 x 115 x 286 mm
Net weight	7.4 - 8.2 kg (16.3 - 18.1 lbs.)

40Vmax



Side Handle, Side Grip, Depth Gauge, Bit Grease, Cloth, Battery, Charger, Z: Battery and Charger are sold separately

### HR008GM201(RM2K) / GZ 30mm (1-3/16") Cordless Combination Hammer

New

Cordless 30 mm (1-3/16") Combination Hammer, SDS-PLUS Bits, Quick Change Drill Chuck

Li-ion Ah 8.0 | 5.0 | 4.0 | 2.5 | 2.0



Impact Energy	EPTA-Procedure: 3.9 J
Capacity	Concrete / Steel / Wood / Core Bit / Diamond Core Bit (Dry Type): 30 / 13 / 32 / 80 / 80 mm (1-3/16 / 1/2 / 1-1/4 / 3-1/8 / 3-1/8")
Blows Per Minute (BPM)	0 - 4,500
No Load Speed (RPM)	0 - 840
Chuck Capacity	1.5 - 13 mm (1/16 - 1/2")
Dimensions (L x W x H)	w/ BL4040: 422 x 103 x 242 mm (16-5/8 x 4-1/16 x 9-1/2")
Net weight	5.2 - 6.2 kg (11.5 - 13.7 lbs.)

40Vmax



Side Grip, Depth Gauge, Battery, Charger, Z: Battery and Charger are sold separately

### HR009GM201(RM2K) / GZ 30mm (1-3/16") Cordless Combination Hammer

New

Cordless 30 mm (1-3/16") Combination Hammer, SDS-PLUS Bits, Quick Change Drill Chuck

Li-ion Ah 8.0 | 5.0 | 4.0 | 2.5 | 2.0



Impact Energy	EPTA-Procedure: 3.9 J
Capacity	Concrete / Steel / Wood / Core Bit / Diamond Core Bit (Dry Type): 30 / 13 / 32 / 80 / 80 mm (1-3/16 / 1/2 / 1-1/4 / 3-1/8 / 3-1/8")
Blows Per Minute (BPM)	0 - 4,500
No Load Speed (RPM)	0 - 840
Chuck Capacity	1.5 - 13 mm (1/16 - 1/2")
Dimensions (L x W x H)	w/ BL4040: 422 x 103 x 242 mm (16-5/8 x 4-1/16 x 9-1/2")
Net weight	5.2 - 6.2 kg (11.5 - 13.7 lbs.)

40Vmax



Quick Change Drill Chuck, Side Grip, Depth Gauge, Battery, Charger, Z: Battery and Charger are sold separately

## Dust Extraction System HEPA filter



HR007G + DX15 (191X39-9)

HR001G + DX12 (191E52-3)  
HR003G + DX12 (191E52-3)

HR002G + DX14 (191E58-1)  
HR004G + DX14 (191E58-1)

HR008G + DX10 (191F95-1)  
HR3011FC + DX10 (191F95-1)

HR009G + DX11 (191G00-4)

**HR001GD201(RD2J) / GZ**  
28mm (1-1/8") Cordless Combination Hammer

Excellent tool balance for easy handling and control

Li-ion Ah 5.0 4.0 2.5 2.0



HR001GD201



HR001GZ



Impact Energy Capacity	EPTA-Procedure 05/2009: 2.8 J Concrete / Steel / Wood / Core Bit / Diamond Core Bit (Dry Type): 28 / 13 / 32 / 54 / 65 mm
Blows Per Minute (BPM)	0 - 5,000
No Load Speed (RPM)	0 - 980
Dimensions (L x W x H)	w/ BL4025: 358x102x232mm (14-1/8"x4"x9-1/8") w/ BL4040: 373x102x238mm (14-3/4"x4"x9-3/8")
Net weight	3.9 - 4.6kg

40Vmax



Side Grip, Depth Gauge, Battery, Charger, Z: Battery and Charger are sold separately

**HR002GM201(RM2J) / GZ**  
28mm (1-1/8") Cordless Combination Hammer

Excellent tool balance for easy handling and control

Li-ion Ah 5.0 4.0 2.5 2.0



HR002GM201

HR002GZ



Quick change drill chuck



Impact Energy Capacity	EPTA-Procedure 05/2009: 2.9 J Concrete / Steel / Wood / Core Bit / Diamond Core Bit (Dry Type): 28 / 13 / 32 / 54 / 65 mm
Blows Per Minute (BPM)	0 - 5,000
No Load Speed (RPM)	0 - 980
Dimensions (L x W x H)	w/ BL4025: 389x102x232mm (15-1/4"x4"x9-1/8") w/ BL4040: 404x102x238mm (15-7/8"x4"x9-3/8")
Net weight	4.1 - 4.6 kg

40Vmax



Side Grip, Depth Gauge, Battery, Charger, Z: Battery and Charger are sold separately

**HR003GM201(RM2J) / GZ**  
28mm (1-1/8") Cordless Combination Hammer

Anti-Vibration Technology (AVT) for extremely low vibration

Li-ion Ah 5.0 4.0 2.5 2.0



HR003GM201



HR003GZ



Impact Energy Capacity	EPTA-Procedure 05/2009: 2.8 J Concrete / Steel / Wood / Core Bit / Diamond Core Bit (Dry Type): 28 / 13 / 32 / 54 / 65 mm
Blows Per Minute (BPM)	0 - 5,000
No Load Speed (RPM)	0 - 980
Dimensions (L x W x H)	w/ BL4025: 358x121x232mm (14-1/8"x4-3/4"x9-1/8") w/ BL4040: 373x102x238mm (14-3/4"x4"x9-3/8")
Net weight	3.9 - 4.6kg

40Vmax



Side Grip, Depth Gauge, Battery, Charger, Z: Battery and Charger are sold separately

**HR004GM201(RM2J) / GZ**  
28mm (1-1/8") Cordless Combination Hammer

Anti-Vibration Technology (AVT) for extremely low vibration

Li-ion Ah 5.0 4.0 2.5 2.0



HR004GM201

HR004GZ



Quick change drill chuck



Impact Energy Capacity	EPTA-Procedure 05/2009: 2.9 J Concrete / Steel / Wood / Core Bit / Diamond Core Bit (Dry Type): 28 / 13 / 32 / 54 / 65 mm
Blows Per Minute (BPM)	0 - 5,000
No Load Speed (RPM)	0 - 980
Dimensions (L x W x H)	w/ BL4025: 389x102x232mm (15-1/4"x4"x9-1/8") w/ BL4040: 404x102x238mm (15-7/8"x4"x9-3/8")
Net weight	4.0 - 4.5 kg

40Vmax



Side Grip, Depth Gauge, Battery, Charger, Z: Battery and Charger are sold separately

**HR007GM201(RM2J) / GZ**  
28mm (1-1/8") Cordless Combination Hammer

Cordless 28mm D-handle combination hammer

Li-ion Ah 5.0 4.0 2.5 2.0



Impact Energy Capacity	EPTA-Procedure 05/2009: 3.0 J Concrete / Steel / Wood / Core Bit / Diamond Core Bit (Dry Type): 28 / 13 / 32 / 54 / 65 mm
Blows Per Minute (BPM)	0 - 5,000
No Load Speed (RPM)	0 - 980
Vibration Level	Hammer Drilling into Concrete: 7.5 m/s <sup>2</sup> Chiselling Function w/ Side Grip: 8.6 m/s <sup>2</sup> Drilling into Metal: 2.8 m/s <sup>2</sup>
Dimensions (L x W x H)	w/ BL4040: 473 x 101 x 240 mm (18-5/8 x 4 x 9-1/2")
Net weight	3.8 - 4.8 kg (8.4 - 10.6 lbs.)

40Vmax



Side Grip, Depth Gauge, Battery, Charger, Cloth, Grease vessel, Z: Battery and Charger are sold separately

**HR010GD201(RD2J) / GZ**  
20mm (13/16") Cordless Combination Hammer

New

40Vmax XGT BL AWS AVT Cordless 20 mm (13/16") Combination Hammer, SDS-PLUS

Li-ion Ah 5.0 4.0 2.5 2.0



Impact Energy Capacity	EPTA-Procedure 05/2009: 2.0 J Concrete (w/ TCT bit) / Steel / Wood: 20 mm / 13 mm / 26 mm
Blows Per Minute (BPM)	0 - 5,000
No Load Speed (RPM)	0 - 1,510
Dimensions (L x W x H)	w/ BL4020 / BL4025: 289 x 93 x 217 mm w/ BL4040: 304 x 93 x 223 mm w/ BL4050F: 323 x 93 x 244 mm
Net weight	2.9 - 4.5 kg (6.4 - 9.9 lbs.)

40Vmax



Side grip, Depth gauge, Battery, Charger, Z: Battery and Charger are sold separately

**Vibration absorbing housing**

**Anti-vibration side grip**

**AVT**  
Anti-Vibration Technology

Low vibration

HR010G: **10.0** m/s<sup>2</sup>

DHR183: **7.5** m/s<sup>2</sup>

Measuring point: at Side grip

— Test conditions —

- Downward drilling, Depth: 80mm
- Drill diameter: ø10.0mm
- Concrete compressive strength: 40N/mm<sup>2</sup> (According to IEC62841-2-6.)

**3 operation modes**

- ⌚ Rotation
- ⌚⌚ Rotation + Hammering
- ⌚ Hammering



Equipped with **HEPA filter**

**DX16**  
(1911P2-6)







**DHR400ZKN 40mm (1-9/16") Cordless Rotary Hammer**

High Power similar to AC Tool

Li-ion Ah 6.0 5.0 3.0 1.5



Impact Energy experimental conditions	EPTA-Procedure 05/2009: 8.0 J 11.4 J
Capacity	Concrete (w/T.C. bit): 40 mm Concrete (w/Core bit): 105 mm
Blows Per Minute (BPM)	1,450 - 2,900
No Load Speed (RPM)	250 - 500
Sound Power Level	102 dB(A)
Dimensions (L x W x H)	473x120x285 mm (18-5/8"x4-3/4"x11-1/4")
Net weight	7.3 - 8.1 kg (16.1 - 17.9 lbs)

18V x2



LXT BL AFT  
AWS AVT SOFT NOLOAD XPT

Side Handle, Side Grip, Depth Gauge, Bit Grease, Cloth, Wireless Unit, Battery, Fast Charger, Z: Battery and Charger are sold separately

**DHR242RTE / Z 24mm (15/16") Cordless Combination Hammer**

Efficient Brushless DC motor provides higher productivity

Li-ion Ah 6.0 5.0 3.0 1.5



DHR242RTE / Z

Impact Energy	2 J
Capacity	Concrete: 24 mm (15/16") Steel: 13 mm (1/2") Wood: 27 mm (1-1/16")
Impacts Per Minute (IPM)	0-4,700
No Load Speed (RPM)	0-950
Sound Power Level	101 dB(A)
Dimensions (L x W x H)	328x85x213 mm (12-7/8"x3-3/8"x8-3/8")
Net weight	3.1 - 3.8 kg (6.7 - 8.4 lbs)

18V



LXT BL XPT

Fast Charger, Battery Cartridge, Depth Gauge, Side Grip, Z: Battery and Charger are sold separately (Tool does not come with bit)



DHR242 + DX06 (199561-6)

HEPA filter

Under load

**AVT**  
ANTI VIBRATION TECHNOLOGY

Active dynamic vibration absorber

- ensures operation with extremely low vibration.
- allows tool design with flat body sides for better handling

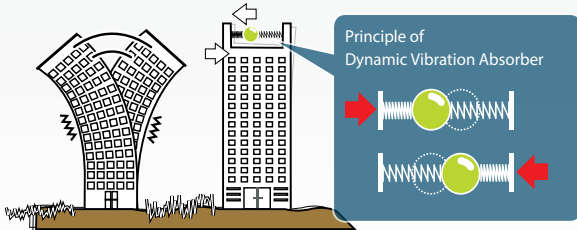
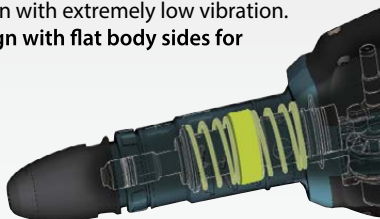

During no-load

**SOFT NO LOAD**

Suppression of motor speed

- reduces vibration of tool body when idling, accordingly decreases the amount of vibration to operator's hands during a day's operation
- minimizes deflection of bit tip from aiming point when starting chipping

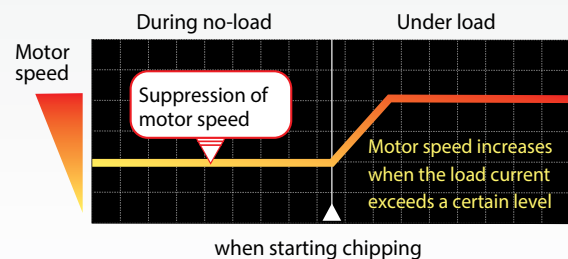

**DHR202RTE / Z 20mm (13/16") Cordless Combination Hammer**

40 different chisel positions for increased comfort and performance

441

Li-ion Ah 6.0 | 5.0 | 3.0 | 1.5



Capacity	Concrete: 20 mm (13/16") Steel: 13 mm (1/2") Wood: 26 mm (1")
Impacts Per Minute (IPM)	0-4,000
No Load Speed (RPM)	0 - 1,100
Sound Power Level	101 dB(A)
Dimensions (L x W x H)	358 x 84 x 259 mm
Net weight	3.2 - 4 kg (7.1 - 8.8 lbs.)

18V



Charger, Battery, Side Grip, Depth Gauge



**HEPA filter**



HR010G + DX16  
DHR183 (1911P2-6)



**DHR183RTWJ / Z 18mm (11/16") Cordless Rotary Hammer**

18V LXT BL AVT Cordless 18 mm (11/16") Rotary Hammer, SDS-PLUS, LED light

Li-ion Ah 6.0 | 5.0 | 3.0 | 1.5



Impact Energy	EPTA-Procedure 05/2009: 1.7 J
Capacity	Concrete: 18 mm (11/16") Steel: 13 mm (1/2") Wood: 24 mm (15/16")
Blows Per Minute (BPM)	0 - 5,000
No Load Speed (RPM)	0 - 1,100
Dimensions (L x W x H)	w/ BL1830B / BL1840B / BL1850B / BL1860B: 288 x 89 x 216 mm (11- 3/8 x 3-1/2 x 8-1/2")
Net weight	1.9 - 2.9 kg (4.2 - 6.4 lbs.)

18V



Side grip, Depth gauge, Battery, Charger, Z: Battery and Charger are sold separately

**HR166DSAE1 / DZ 16mm (5/8") Adapted for SDS-PLUS bits**

12Vmax CXT BL Brushless Cordless 16 mm (5/8") Rotary Hammer, SDS-PLUS Bits

Li-ion Ah 5.0 | 4.0 | 2.0 | 1.5

HR166DSAE1



Impact Energy	1.1 J
Capacity	Concrete: 16 mm (5/8") Steel: 10 mm (3/8") Wood: 13 mm (1/2")
Blows Per Minute (BPM)	0 - 4,800
No Load Speed (RPM)	0 - 680
Sound Power Level	97 dB(A)
Dimensions (L x W x H)	250x74x187 mm
Net Weight	1.8 - 2.4kg (4.1 - 5.4lbs)

12Vmax



Battery, Charger, DZ: Battery and Charger are sold separately

**HR1840J 18mm (11/16") Rotary Hammer**

2-Mode operation for "Rotation Only" or "Hammering with Rotation"

459



Continuous Rating Input	470W
Capacity	Our experimental conditions: 1.4 J Concrete (with T.C.T. bit): 18mm (11/16") Steel: 13 mm (1/2") Wood: 24 mm (15/16")
Blows Per Minute (BPM)	0 - 4,800
No Load Speed (RPM)	0 - 1,900
Dimensions (L x W x H)	285x75x208mm (11-1/4"x3"x8-3/16")
Net Weight	2.0 - 2.4 kg (4.3 - 5.3 lbs.)

2 modes



Depth Gauge, Side Grip

**HR2020 20mm (3/4") Rotary Hammer**

Simple and solid construction, yet powerful performance

419



Continuous Rating Input	710W
Capacity	Concrete: 20 mm (3/4") Steel: 13 mm (1/2") Wood: 32 mm (1-1/4")
Blows Per Minute (BPM)	0 - 4,050
No Load Speed (RPM)	0 - 1,050
Overall Length	352 mm (13-7/8")
Net Weight	2.3 kg (5.1 lbs)
Power Supply Cord	2.5kg (8.2ft)



Depth Gauge, Side Grip

**HR2300/B 23mm (7/8") Rotary Hammer**

Easy-to-grip handle ergonomically designed to give maximum power thrust

325



Continuous Rating Input	720W
Capacity	Concrete: 23 mm (7/8") Steel: 13 mm (1/2") Wood: 32 mm (1-1/4")
Blows Per Minute (BPM)	0-4,600
No Load Speed (RPM)	0-1,200
Sound Power Level	101 dB(A)
Dimensions (L x W x H)	356x77x209mm (14"x3"x8-1/4")
Net Weight	2.7 - 3.1 kg (5.9 - 6.9lbs)
Power Supply Cord	2.5kg (8.2ft)



Side Grip, Depth Gauge (Tool does not come with bit)



**HR2470X5 24mm (15/16") Combination Hammer**

High durability in mechanical parts, motor and carbon brush 325

**110V**

**HR2470X5/B**



Continuous Rating Input Capacity	780W Concrete: 24 mm (15/16") Core Bit: 54 mm (2-1/8") Steel: 13 mm (1/2") Wood: 32 mm (1-1/4")
Blows Per Minute (BPM)	0 - 4,500
No Load Speed (RPM)	0 - 1,100
Sound Power Level	101 dB(A)
Dimensions (L x W x H)	370x84x214 mm (14-1/2"x3-5/16"x8-3/8")
Net Weight	2.9 - 3.3kg (6.4 - 7.3lbs)
Power Supply Cord	2.5kg (8.2ft)



Side Handle, Depth Gauge, Quick Change Drill Chuck



**NEMESIS II**

**nemesis II drill bit for SDS-PLUS Hammers**

Five-star range



**Centering tip**

Stable and secure drilling

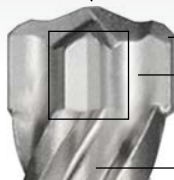

**Wearing mark**

Indicator for evaluating the dimensional stability of the anchor holes

**Innovated flute geometry**

Faster drilling

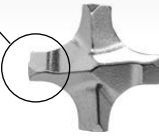

**Rebar chamfer**

Reduce shock in reinforcement strikes

**Solid TCT (5 - 10mm)**  
**One piece TCT (11 - 16mm)**  
**Three piece TCT (18 - 32mm)**

- \*One piece solid carbide tip (5-10mm)
- \*No seizing up on hitting reinforcing steel
- \*Ensure precision drill holes
- \*Drills more precisely
- \*Low vibration and high fracture resistance

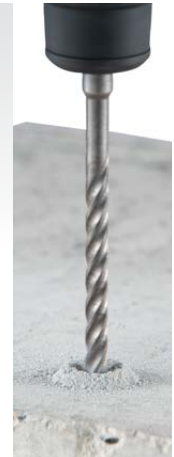

**HR2630X3 26mm (1") Combination Hammer**

26mm (1") Combination Hammer 325

**110V**

**HR2630/B**



Continuous Rating Input Capacity	800W Concrete: 26 mm (1") Core Bit: 68 mm (2-11/16") Diamond Core Bit (Dry Type): 80 mm (3-1/8") Steel: 13 mm (1/2") Wood: 32 mm (1-1/4")
Blows Per Minute (BPM)	0 - 4,600
No Load Speed (RPM)	0 - 1,200
Sound Power Level	101 dB(A)
Dimensions (L x W x H)	385x77x209 mm (15-1/8"x3"x8-1/4")
Net Weight	3.0 kg (6.6 lbs)
Power Supply Cord	2.5 m (8.2 ft)



Side Grip, Depth Gauge

Tool does not come with bit

**HR2810 28mm (1-1/8") Combination Hammer**

3 operation modes - hammering, hammering with rotation, rotation 325

**110V**

**HR2810/B**



Continuous Rating Input Capacity	800W Concrete (with T.C.T. bit): 28mm (1-1/8") Steel: 13 mm (1/2") Wood: 32 mm (1-1/4")
Blows Per Minute (BPM)	0-4,500
No Load Speed (RPM)	0-1,100
Sound Power Level	100 dB(A)
Dimensions (L x W x H)	314x89x225 mm (12-3/8"x3-1/2"x8-7/8")
Net Weight	3.4 - 3.8kg (7.5 - 8.5lbs)
Power Supply Cord	4.0 m (13.1 ft)

Tool does not come with bit



Side Grip, Depth Gauge

**HR3001CJ 30mm (1-3/16") Combination Hammer**

Drilling efficiency drastically increased by redesigned hammering mechanism 350



Continuous Rating Input Capacity	1,050W EPTA-Procedure 05/2009: 3.9 J Our experimental conditions: 4.5 J
Capacity	Concrete (w/ TCT Bit): 30 mm (1-3/16") Concrete (w/ Core Bit): 80 mm (3-1/8") Concrete (w/ Diamond Core Bit): 80 mm (3-1/8") Steel: 13 mm (1/2") Wood: 32 mm (1-1/4")
Blows Per Minute (BPM)	0 - 4,500
No Load Speed (RPM)	0 - 840
Dimensions (L x W x H)	369 x 98 x 226 mm
Net Weight	4.1 - 4.5 kg (9.0 - 9.9 lbs.)
Power Supply Cord	4.0 m (13.1 ft)



Depth Gauge, Side Grip

## HR3011FCJ 30mm (1-3/16") Combination Hammer

Powerful yet with low vibration due to 2 Counterweights

350



Continuous Rating Input	1,050W
Impact Energy	EPTA-Procedure 05/2009: 3.9 J Our experimental conditions: 4.5 J
Capacity	Concrete (w/ TCT Bit): 30 mm (1-3/16") Concrete (w/ Core Bit): 80 mm (3-1/8") Concrete (w/ Diamond Core Bit): 80 mm (3-1/8") Steel: 13 mm (1/2") Wood: 32 mm (1-1/4")
Blows Per Minute (BPM)	0 - 4,500
No Load Speed (RPM)	0 - 840
Dimensions (L x W x H)	369 x 98 x 242 mm
Net Weight	4.4 - 4.8 kg (9.7 - 10.6 lbs)
Power Supply Cord	4.0 m (13.1 ft)



Depth Gauge, Side Grip

## HR3200C 32mm (1-1/4") Combination Hammer

3 operation modes - hammering, hammering with rotation, rotation

350



Continuous Rating Input	850W
Capacity	Concrete (with T.C.T. bit): 32mm (1-1/4") Steel: 13 mm (1/2") Wood: 32 mm (1-1/4")
Blows Per Minute (BPM)	1,650-3,300
No Load Speed (RPM)	315-630
Dimensions	398x108x239 mm (15-5/8"x4-1/4"x9-3/8")
Net Weight	4.8 - 5.2 kg (10.5 - 11.5 lbs)
Power Supply Cord	5.0m (16.4ft)



Depth Gauge, Side Grip, Grease Vessel

## HR4002 40mm (1-9/16") Rotary Hammer

High efficiency by high speed

350

110V

HR4002/B



Continuous Rating Input	1,050W
Capacity	Concrete (with T.C.T. bit): 40mm (1-9/16") Concrete (with Core bit): 105mm (4-1/8")
Blows Per Minute (BPM)	2,500
No Load Speed (RPM)	680
Sound Power Level	103 dB(A)
Dimensions	458x114x256mm (18"x4-1/2"x10-1/8")
Net Weight	6.6 - 6.8 kg (14.6 - 15.0 lbs)
Power Supply Cord	5.0m (16.4ft)



Side Grip, Bit Grease, Depth Gauge

## HR4003C 40mm (1-9/16") Rotary Hammer

Most powerful and efficient in the class

350

110V

HR4003C/B



Continuous Rating Input	1,100W
Capacity	Concrete (with T.C.T. bit): 40mm (1-9/16") Concrete (with Core bit): 105mm (4-1/8")
Blows Per Minute (BPM)	1,450 - 2,900
No Load Speed (RPM)	250-500
Dimensions	479x106x263mm (18-11/16"x4-3/8"x10-3/8")
Net Weight	6.2 kg (13.8 lbs)
Power Supply Cord	5.0m (16.4ft)



Depth Gauge, Side Handle, Bit Grease

## HR4013C 40mm (1-9/16") Rotary Hammer

High efficiency and unrivalled low level of vibration

350



Continuous Rating Input	1,100W
Capacity	Concrete (with T.C.T. bit): 40mm (1-9/16") Concrete (with Core bit): 105mm (4-1/8")
Blows Per Minute (BPM)	1,450 - 2,900
No Load Speed (RPM)	250 - 500
Dimensions	479x112x263mm (18-11/16"x4-3/8"x10-3/8")
Net Weight	6.8 - 6.9 kg (14.9 - 15.3 lbs)
Power Supply Cord	5.0m (16.4ft)

Tool does not come with bit



Depth Gauge, Side Handle, Bit Grease

## HR4501C 45mm (1-3/4") Rotary Hammer

High performance and durability

175



Continuous Rating Input	1,350W
Capacity	Concrete (with T.C.T. bit): 45mm (1-3/4") Concrete (with Core bit): 125mm (5")
Blows Per Minute (BPM)	1,250 - 2,750
No Load Speed (RPM)	130 - 280
Dimensions	458x121x288mm (18"x4-3/4"x11-3/8")
Net Weight	8.2 - 8.4 kg (18.1 - 18.5 lbs)
Power Supply Cord	5.0m (16.4ft)

Tool does not come with bit



Side Handle(D), Side Grip, Depth Gauge, Grease Vessel

## HR5202C 52mm (2-1/16") Rotary Hammer

High efficiency and durability

175

110V

HR5202C/B



Continuous Rating Input	1,510W
Capacity	Concrete (with T.C.T. bit): 52mm (2") Concrete (with Core bit): 160mm (6-5/16")
Blows Per Minute (BPM)	1,100 - 2,250
No Load Speed (RPM)	150 - 310
Sound Pressure Level	99 dB(A)
Sound Power Level	110 dB(A)
Dimensions	599x134x287mm (23-1/2"x5-1/4"x11-1/4")
Net Weight	10.9 - 11.1 kg (24.1-24.4 lbs)
Power Supply Cord	5.0m (16.4ft)

Tool does not come with bit



Side handle (D), Side grip, Depth gauge, Grease vessel

## HR5212C 52mm (2-1/16") Rotary Hammer

High efficiency and unrivalled low level of vibration

175



Continuous Rating Input	1,510W
Capacity	Concrete (with T.C.T. bit): 52mm (2") Concrete (with Core bit): 160mm (6-5/16")
Blows Per Minute (BPM)	1,100 - 2,250
No Load Speed (RPM)	150 - 310
Dimensions	599x140x287mm (23-1/2"x5-1/2"x11-1/4")
Net Weight	11.9-12.0 kg (26.2-26.5 lbs)
Power Supply Cord	5.0m (16.4ft)

Tool does not come with bit



Side Handle (D), Side Grip, Depth Gauge, Grease Vessel



# DEMOLITION HAMMER

## PRODUCTS



### DHK180Z Cordless Power Scraper

18V LXT BL AVT Cordless Power Scraper, SDS-PLUS Bits

Li-ion Ah 6.0 5.0 3.0 1.5



Impact Energy	EPTA-Procedure 05/2009: 3.1 J Our experimental conditions: 3.9 J
Blows Per Minute (BPM)	0 - 3,200
Vibration Level	Chiselling: 4.5 m/s <sup>2</sup>
Sound Pressure Level	83 dB(A)
Sound Power Level	94 dB(A)
Dimensions (L x W x H)	368x99x211mm (14-1/2"x3-7/8"x8-5/16")
Net weight	3.3 - 3.6 kg (7.3 - 7.9 lbs.)

18V



Bull Point, Scaling chisel (for tile), Hook, Battery, Charger, Z: Battery and Charger are sold separately

### HK1820 Power Scraper

Compact and lightweight. One-touch sliding chuck

350 W



Continuous Rating Input	550W
Blows Per Minute (BPM)	0-3,200
Dimensions (L x W x H)	351x102x203mm (13-3/4"x4"x8")
Net Weight	3.4kg (7.5lbs)
Power Supply Cord	5.0m (16.4ft)



Bull Point, Scaling Chisel, Scaling Chisel (For Tile), Hook Complete

### HM002GZ03(K) Cordless Demolition Hammer

40Vmax X2 & BL motor for 20.0 J high power

Li-ion Ah 8.0 5.0 4.0 2.5 2.0



Impact Energy	EPTA-Procedure 05/2009: 20.9 J
Blows Per Minute (BPM)	950 - 1,900
Max Output	2,600W
Shank Diameter	18mm (11/16")
Dimensions (L x W x H)	w/BL4025: 574 x 146 x 324mm (22-5/8 x 5-3/4 x 12-3/4") w/BL4040: 574 x 146 x 324mm (22-5/8 x 5-3/4 x 12-3/4")
Net weight	12.0 - 13.3 kg (26.5 - 29.3 lbs.)

1

40Vmax x2



Grease for bit, Side Handle, Battery, Charger, Z: Battery and Charger are sold separately

### HM001GZ03(K) Cordless Demolition Hammer

High power and compact

Li-ion Ah 8.0 5.0 4.0 2.5 2.0



Impact Energy	EPTA-Procedure 05/2009: 9.4 J
Blows Per Minute (BPM)	0 - 2,650
Shank Diameter	18mm (11/16")
Sound Power Level	100 dB(A)
Dimensions (L x W x H)	w/BL4025: 481 x 113 x 258mm (19 x 4-7/16 x 10-1/8") w/BL4040: 496 x 113 x 258mm (19-1/2 x 4-7/16 x 10-1/8")
Net weight	6.3 - 7.1 kg (13.9 - 15.7 lbs.)

1

40Vmax



Bit Grease, Cloth, Battery, Charger, Z: Battery and Charger are sold separately



### HM0810A 17mm (11/16") Hex Shank Demolition Hammer

Perfect combination of power, durability and compact design

105 W



Continuous Rating Input	900W
Blows Per Minute (BPM)	2,900
Sound Power Level	103 dB(A)
Overall Length	410 mm (16-1/8")
Net Weight	6.7kg (14.7lbs)
Power Supply Cord	5.0m (16.4ft)



Bull Point, Hex Wrench, Side Grip

**HM0810TA**

17mm (11/16") Hex Shank Demolition Hammer

Perfect combination of power, durability and compact design

105

110V

**HM0810TA/B**

Continuous Rating Input	900W
Blows Per Minute (BPM)	2,900
Sound Power Level	103 dB(A)
Overall Length	410 mm (16-1/8")
Net Weight	6.7kg (14.7lbs)
Power Supply Cord	5.0m (16.4ft)



Bull Point, Hex Wrench, Side Grip

**HM0870C** Demolition Hammer

High durability and excellent demolition performance

350

110V

**HM0870C/B**

Continuous Rating Input	1,100W
Blows Per Minute (BPM)	1,100-2,650
Sound Power Level	98 dB(A)
Dimensions (L x W x H)	449x109x230mm (17-3/4"x4-1/4"x9")
Net Weight	5.1-5.3kg (11.1-11.6lbs)
Power Supply Cord	5.0m (16.4ft)

Tool does not come with bull point



Grease for Bit, Side Handle

**HM0871C** Demolition Hammer

AVT (Anti-Vibration Technology) ensures extra-low vibration performance

350



Continuous Rating Input	1,100W
Blows Per Minute (BPM)	1,100-2,650
Sound Power Level	97 dB(A)
Vibration Level	Chiseling: 8.0 m/s <sup>2</sup>
Dimensions (L x W x H)	466x116x230mm (18-3/8"x4-9/16"x9")
Net Weight	5.6-5.8kg (12.4-12.8lbs)
Power Supply Cord	5.0m (16.4ft)

Tool does not come with bull point



Grease for Bit, Side Handle

**HM1205C** Demolition Hammer

19.1 J Demolition Hammer, SDS-MAX Bits

175



Continuous Rating Input	1,510W
Blows Per Minute (BPM)	950 - 1,900
Dimensions (L x W x H)	576x128x265mm (22-3/4"x5"x10-3/8")
Net Weight	9.7kg (21.4lbs)
Power Supply Cord	5.0m (16.4ft)



Bull Point, Bit Grease, Side Handle

**HM1213C** Demolition Hammer

AVT (Anti-Vibration Technology) ensures extra-low vibration performance

175



Continuous Rating Input	1,510W
Blows Per Minute (BPM)	950-1,900
Sound Power Level	95 dB(A)
Dimensions (L x W x H)	576x149x265mm (22-3/4"x5-7/8"x10-3/8")
Net Weight	10.8kg (23.6lbs)
Power Supply Cord	5.0m (16.4ft)



Bull Point, Bit Grease, Side Handle

**HM1214C** Demolition Hammer

Comfortable operation at hammering downward

175



Continuous Rating Input	1,510W
Blows Per Minute (BPM)	950-1,900
Sound Power Level	98 dB(A)
Dimensions (L x W x H)	700x129x265mm (27-1/2"x5-1/8"x10-3/8")
Net Weight	12.3kg (27.1lbs)
Power Supply Cord	5.0m (16.4ft)

**HM1306** 30mm (1-3/16") Hex Shank Demolition Hammer

21.7 J Demolition Hammer, 30 mm Hex Shank

204

110V

**HM1306/B**

Continuous Rating Input	1,510W
Blows Per Minute (BPM)	1,450
Dimensions (L x W x H)	652x121x231mm (25-3/4"x4-3/4"x9-1/8")
Net Weight	15.1kg (33.3lbs)
Power Supply Cord	5.0m (16.4ft)



Bull Point, Wrench, Side Handle, Oil Supply 100ml

**HM1501** 30mm (1-3/16") Electric Breaker

48.1 J Electric Breaker, 30 mm Hex Shank

218



Continuous rating input	1,850W
Impact Energy	EPTA-Procedure 05/2009: 48.0 J
Blows Per Minute (BPM)	1,300
Dimensions (L x W x H)	781 x 130 x 265 mm (30-3/4 x 5-1/8 x 10-3/8")
Net weight	18.4 kg (40.6 lbs.)
Power supply cord	5.0 m (16.4 ft)



Side Handle



**HM1511 30mm (1-3/16") Electric Breaker**

48.9 J AVT SOFT NO LOAD Electric Breaker, 30 mm Hex Shank

218



Continuous rating input	1,850W
Impact Energy	EPTA-Procedure 05/2009: 48.0 J
Blows Per Minute (BPM)	1,300
Dimensions (L x W x H)	781 x 130 x 265 mm (30-3/4 x 5-1/8 x 10-3/8")
Net weight	19.2 kg (42.4 lbs.)
Power supply cord	5.0 m (16.4 ft)



Side Handle

**HM1812 28.6mm (1-1/8") Electric Breaker**

Highest-in-class demolition power with AVT

218



**HM1812/B**



Continuous Rating Input	2,000W
Blows Per Minute (BPM)	870
Sound Power Level	107 dB(A)
Dimensions (L x W x H)	843x210x608mm (33-1/4"x8-1/4"x24")
Net Weight	31.3kg (69.1lbs)
Power Supply Cord	5.0m (16.4ft)



Bull point, Hex wrench

**RECIPRO SAW**

**PRODUCTS**



**JR002GM201(RM2J) / GD201(RD2J) / GZ 32mm (1-1/4") Cordless Recipro Saw**

Compatible with a wide range of cutting applications

Li-ion Ah 8.0 5.0 4.0 2.5 2.0



Length of Stroke	32 mm (1-1/4")
Strokes Per Minute (SPM)	0 - 3,000
Capacity	Pipe: 130 mm (5-1/8") Wood: 255 mm (10") w/ BL4020 / BL4025: 436 x 97 x 250 mm (17-1/8 x 3-13/16 x 9-7/8")
Dimensions (L x W x H)	
Net weight	4.6 - 5.2 kg (10.1 - 11.5 lbs.)



Recipro Saw Blades, Charger, Battery, Z: Battery and Charger are sold separately

**JR001GM201(RM2J) / GD201(RD2J) / GZ 32mm (1-1/4") Cordless Recipro Saw**

Compact & High Power

Li-ion 5.0 4.0 2.5 2.0



Length of Stroke	32 mm (1-1/4")
Strokes Per Minute (SPM)	High / Low: 0 - 3,000 / 0 - 2,300
Capacity	Pipe: 130 mm (5-1/8") Wood: 255 mm (10") w/ BL4025: 457x88x233 mm (18"x3-1/2"x9-1/8") w/ BL4040: 472x88x239 mm (18-5/8"x3-1/2"x9-3/8")
Dimensions (L x W x H)	
Net weight	4.2 - 4.5 kg (9.3 - 9.9 lbs.)



Recipro Saw Blades, Charger, Battery, Z: Battery and Charger are sold separately

**DJR360Z 32mm (1-1/4") Cordless Recipro Saw**

Improvement in specifications of cutting speed and stroke length

Li-ion Ah 6.0 5.0 3.0 1.5



Capacity	Pipe: 130mm (5-1/8") Wood: 255mm (10")
Length of stroke	32mm (1-1/4")
Strokes per minute (spm)	High: 0-3,000 Low: 0-2,300
Sound power Level	96 dB(A)
Dimensions (L x W x H)	449x116x243mm (17-3/4"x4-9/16"x9-9/16")
Net weight	4.0kg (8.9lbs)



Fast Charger, Batteries, Recipro saw blades, Z: Battery and Charger are sold separately

**DJR187RTE / ZK 32mm (1-1/4") Cordless Recipro Saw**

Upgraded model of basic model DJR186 high efficiency by Brushless DC Motor

Li-ion Ah 6.0 5.0 3.0 1.5



Length of Stroke	32 mm (1-1/4")
Strokes Per Minute (SPM)	High / Low: 0 - 3,000 / 0 - 2,300
Capacity	Pipe: 130 mm (5-1/8") Wood: 255 mm (10")
Sound Power Level	95 dB(A)
Dimensions (L x W x H)	439x83x231 mm (17-1/4"x3-1/4"x9-1/8")
Net weight	3.4 - 3.8 kg (7.6 - 8.3 lbs)



Fast Charger, Batteries, Recipro saw blades, Z: Battery and Charger are sold separately

**DJR186RTE / ZK 32mm (1-1/4") Cordless Recipro Saw**

Higher cutting speed (Max 2,800 SPM)



Li-ion Ah 6.0 5.0 3.0 1.5



Length of Stroke	32 mm (1-1/4")
Strokes Per Minute (SPM)	0 - 2,800
Capacity	Pipe: 130 mm (5-1/8") Wood: 255 mm (10")
Sound Power Level	95 dB(A)
Dimensions (L x W x H)	486x81x223 mm (19-1/8"x3-3/16"x8-3/4")
Net weight	3.5 - 3.8 kg (7.6 - 8.3 lbs)

18V



Fast Charger, Batteries, Recipro saw blades, Z: Battery and Charger are sold separately

**DJR188RTJ / Z 20mm (13/16") Cordless Recipro Saw**

Two switch levers are available with variable speed control

Li-ion Ah 6.0 5.0 3.0 1.5



Length of Stroke	20 mm (13/16")
Strokes Per Minute (SPM)	0 - 3,000
Capacity	Pipe: 130 mm (5-1/8") Wood: 255 mm (10")
Sound Power Level	94 dB(A)
Dimensions (L x W x H)	with BL1815N / BL1820B: 316x81x203 mm (12-1/2"x3-3/16"x8") with BL1830B / BL1840B / BL1850B / BL1860B: 316x81x220 mm (12-1/2"x3-3/16"x8-5/8")
Net weight	2.6 - 2.9 kg (5.7 - 6.4 lbs)

18V



Recipro Saw Blades, Battery, Fast Charger, Z: Battery and Charger are sold separately

**DJR189RTJ / Z 22 mm (7/8") Cordless Recipro Saw**

Good combination of compact design and high power

Li-ion Ah 6.0 5.0 3.0 1.5



Capacity	Pipe: 130 mm (5-1/8") Wood: 255 mm (10")
Length of stroke	22 mm (7/8")
Strokes Per Minute (SPM)	0-3,100
Dimensions (L x W x H)	410 x 81 x 182 mm (16-1/8 x 3-3/16 x 7-1/8")
Net weight	2.2 - 2.5 kg (4.9 - 5.5 lbs.)

18V



Recipro saw blades, Battery, Charger, Z: Battery and Charger are sold separately

**BL MOTOR** High operating efficiency

Counter weight mechanism

Photo: DJR189

Vibration Level  
Cutting boards **9.0 m/s<sup>2</sup>**

**DJR183RTE / Z 13mm (1/2") Cordless Recipro Saw**

Two switch levers are available with variable speed control

Li-ion Ah 6.0 5.0 3.0 1.5



Capacity	Pipe: 50 mm (2") Wood: 50 mm (2")
Length of Stroke	13 mm (1/2")
Strokes Per Minute (SPM)	0-3,000
Dimensions (L x W x H)	392x81x209 mm (15-1/2"x3-3/16"x8-1/4")
Net weight	1.5 - 1.7 kg (3.3 - 3.8 lbs)

18V



Fast Charger, Battery Cartridge X2, Recipro Saw Blades, Z: Battery and Charger are sold separately

**JR103DWYE 13mm (1/2") Cordless Recipro Saw**

Slide style battery and improved ergonomic grip

Li-ion Ah 5.0 4.0 2.0 1.5



Length of Stroke	13mm (1/2")
Strokes Per Minute (SPM)	0 - 3,300
Capacity	Pipe: 50mm (2") Wood: 50mm (2")
Dimensions (L x W x H)	376x66x186mm (14-3/4"x2-5/8"x7-3/8")
Net Weight	1.3 - 1.5kg (2.9 - 3.3lbs)

12Vmax



Battery, Charger, Recipro Saw Blades, Hex Wrench

**JR3051TK 30mm (1-3/16") Recipro Saw**

1,200 W Recipro Saw



Continuous rating input	1,200W
Length of Stroke	30 mm (1-3/16")
Strokes Per Minute (SPM)	0 - 3,000
Capacity	Pipe: 130 mm (5-1/8") Wood: 255 mm (10")
Sound Power Level	99 dB(A)
Dimensions (L x W x H)	447x97x176mm (17-5/8"x3-13/16"x6-15/16")
Net Weight	3.2 - 3.3 kg (7.1 - 7.3 lbs.)
Power supply cord	2.5 m (8.2 ft)



Recipro Saw Blades

**JR3070CT 32mm (1-1/4") Recipro Saw**

Extra-low vibration and extra power



**110V**  
JR3070CT/B



Continuous rating input	1,510W
Length of Stroke	32 mm (1-1/4")
Strokes Per Minute (SPM)	0 - 2,800
Capacity	Pipe: 130 mm (5-1/8") Wood: 255 mm (10")
Sound Power Level	100 dB(A)
Overall Length	485 mm (19-1/8")
Net Weight	4.6 kg (10.0 lbs)
Power supply cord	2.5 m (8.2 ft)



Recipro Saw Blade Set



# CUTTING

## Masonry & Concrete

### PRODUCTS

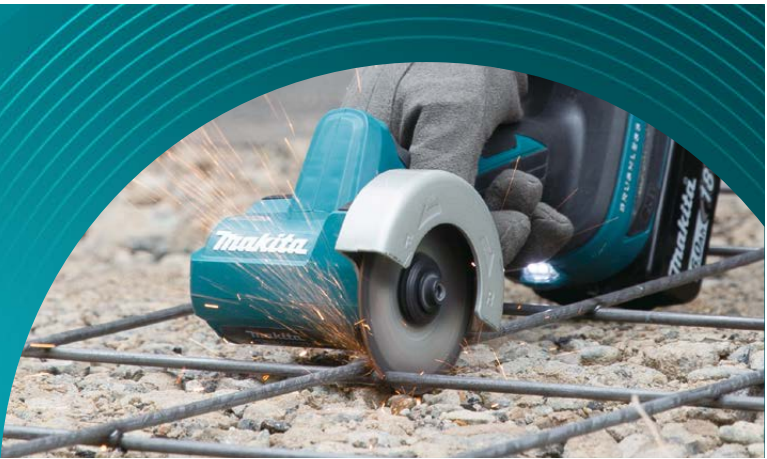

#### DCC500RTE / Z 125mm (5") Cordless Cutter

18V LXT BL AWS ADT Cordless 125 mm (5") Cutter, Dry Type

Li-ion Ah 6.0 | 5.0 | 3.0 | 1.5

Blade Diameter	125 mm (5")
Hole Diameter	20 mm (13/16")
Max Cutting Capacity	90°: 40.0 mm (1-9/16") 45°: 27 mm
No Load Speed (RPM)	8,500
Dimensions (L x W x H)	w/ BL1830B / BL1850B / BL1860B: 283 x 158 x 172 mm
Net weight	2.6 - 3.1 kg (5.7 - 6.8 lbs.)



DCC500RTE / Z  
1

18V LXT BL AWS ADT XPT

Dust Bag, Hex Wrench, Z: Battery and Charger are sold separately

#### DMC300RTJ / Z Cordless Compact Cut Off

18V LXT BL AFT Cordless 76 mm (3") Compact Cut Off

Li-ion Ah 6.0 | 5.0 | 3.0 | 1.5

Blade Diameter	76 mm (3")
No Load Speed (RPM)	20,000
Max cutting capacity	w/ Dust cover attachment: 13.5 mm (1/2") w/o Dust cover attachment: 16.0 mm (5/8")
Dimensions (L x W x H)	w/ BL1830B / BL1850B / BL1860B: 271 x 104 x 182 mm (10-5/8 x 4-1/8 x 7-1/8")
Net weight	1.2 - 1.7 kg (2.6 - 3.7 lbs.)



18V LXT BL AFT XPT

Dust Collection Cover, Diamond Wheel, Hex Wrench, Battery, Charger, Z: Battery and Charger are sold separately

## 76mm (3") cutter suitable for small cutting jobs



**Cutting wheel/ thin thickness (Cut-off wheel)**  
Cutting materials: Steels, Stainless steels



**Tungsten carbide grit (Multi carbide wheel)**  
Cutting materials: Drywalls, plastic boards, Ceramic siding boards



**Diamond wheel/ rim**  
Cutting materials: Tiles

photo: DMC300



#### Constant speed control

minimizes the reduction in blade speed to provide stable cutting.

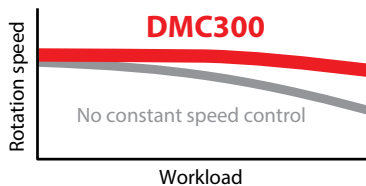

**Circumference of grip portion**

#### Reverse switch

enabling to deflect sparks and dust according to working situation



<b>Work amount</b>	on a full battery charge battery: BL1860B	
<b>Metal cutting</b>	Cut off M10 steel rods	<b>Tile cutting</b>
about		Cut off 300x5.5mm tiles
<b>283 pcs</b>		about
Wheel used: cut-off wheel		<b>23 m</b>
		Wheel used: diamond wheel

**Max cutting capacity 16mm** | **No load speed 20,000 min<sup>-1</sup>**

## CC301DSYE 85mm (85-3/8") Cordless Cutter

Smooth and powerful cutting at the high rotational speed

Li-ion Ah 5.0 4.0 2.0 1.5



Blade Diameter	85 mm (3-3/8")
Max Cutting Capacity	90°: 25.5 mm (1") 45°: 16.5 mm (5/8")
No Load Speed (RPM)	1,600
Tank Capacity	Water: 0.5 L
Vibration Level	Concrete Cutting: 2.5 m/s <sup>2</sup>
Sound Power Level	95 dB(A)
Dimensions (L x W x H)	313x170x125mm (12-3/8"x6-11/16"x4-7/8")
Net Weight	1.9kg (4.1lbs)

12Vmax



Fast Charger, Battery Cartridge, Diamond Wheel, Hex Wrench, Water Supply Tank Ass'y, DZ: Battery and Charger are sold separately

## SG1251J 125mm (5") Wall Chaser

Compact design for perfect handling

318



Continuous Rating Input	1,400W
Capacity	Depth: 0-30mm (0 - 1-3/16") Width: 6-30 mm (1/4 - 1-3/16")
Blade Diameter	125 mm (5")
No Load Speed (RPM)	10,000
Dimensions (L x W x H)	350x151x178mm (13-3/4"x5-15/16"x7")
Net Weight	4.3kg (9.5lbs)
Power Supply Cord	5.0m (16.4ft)



Diamond Wheel x 2, Hex Wrench, Lock Nut Wrench

## 4100NH 110mm (4-3/8") Cutter

More powerful cutting in stone, masonry, tile and concrete

303



Continuous Rating Input	1,300W
Blade Diameter	110 mm (4-3/8")
Max Cutting Capacity	90°: 34 mm (1-3/8")
No Load Speed (RPM)	14,500
Dimensions (L x W x H)	234x210x165 mm (9-1/4"x8-1/4"x6-1/2")
Net Weight	2.9 kg (6.5 lbs)
Power Supply Cord	2.5 m (8.2 ft)

Tool does not come with diamond wheel



Wrench, Socket Wrench (Tool does not come with diamond wheel)

## 4100NH3Z 110mm (4-3/8") Cutter

Powerful 1,300 W motor delivers 13,800 RPM

303



Continuous Rating Input	1,200W
Blade Diameter	110 mm (4-3/8")
Max Cutting Capacity	90°: 32 mm (1-1/4")
No Load Speed (RPM)	13,800
Dimensions (L x W x H)	227x209x166mm (8-15/16"x8-1/4"x6-1/2")
Net Weight	2.8 kg (6.2 lbs)
Power Supply Cord	2.0 m (6.6 ft)

Tool does not come with diamond wheel. Items of standard equipment and specifications may vary by country or area



Wrench, Hex Wrench

## 4100KB 125mm (5") Dustless Cutter

125 mm (5") 1,400 W Dustless Cutter, Dry Type

303



Continuous Rating Input	1,400W
Blade Diameter	125 mm (5")
Max Cutting Capacity	40.0 mm (1-9/16")
No Load Speed (RPM)	12,200
Dimensions (L x W x H)	231x220x179 mm (9-1/8"x8-5/8"x7")
Net Weight	3.0 kg (6.6 lbs.)
Power Supply Cord	2.5 m (8.2 ft.)



Diamond Wheel, Dust Bag, Wrench, Hex Wrench

## 4107R 180mm (7-1/8") Cutter

Quick and clean cutting

153



Continuous Rating Input	1,400W
Capacity	Max cutting: 60mm (2-3/8") 180 mm (7-1/8")
Blade Diameter	180 mm (7-1/8")
No Load Speed (RPM)	5,000
Overall Length	370 mm (14-9/16")
Net Weight	6.3kg (14.5lbs)
Power Supply Cord	5.0m (16.4ft)

Tool does not come with diamond wheel



Socket Wrench, Offset Wrench, Water Plug &amp; Tube

## 4112HS 305mm (12") Angle Cutter

305m (12") diamond wheel provides max. cutting depth of 100mm (4")

204



Continuous Rating Input	2,400W
Capacity	Max cutting: 100mm (4")
Blade Diameter	305 mm (12")
No Load Speed (RPM)	5,000
Overall Length	648 mm (25-1/2")
Net Weight	10.4kg (22.9lbs)
Power Supply Cord	2.5m (8.2ft)

Tool does not come with diamond wheel



Socket Wrench

## 4114S 355mm (14") Angle Cutter

High torque delivered at low motor speed of 3,500 rpm

204



Continuous Rating Input	2,400W
Capacity	Max cutting: 125mm (5")
Wheel Diameter	355 mm (14")
Hole Diameter	25.4mm (1")
No Load Speed (RPM)	3,500
Dimensions (L x W x H)	673x240x329mm (26-1/2"x9-1/2"x13")
Net Weight	10.8kg (23.9lbs)
Power Supply Cord	2.5m (8.2ft)

Tool does not come with diamond wheel



Wrench



# METAL CUTTING

## PRODUCTS



### CS002GZ 185mm (7-1/4") Cordless Metal Cutter

Equipped with a Lever for opening/closing Safety cover

Li-ion Ah 8.0 | 5.0 | 4.0 | 2.5 | 2.0



Wheel Diameter	185 mm (7-1/4")
Max Cutting Capacity	67 mm (2-5/8")
No Load Speed (RPM)	3,500
Sound Power Level	113 dB(A)
Dimensions (L x W x H)	350 x 232 x 270 mm (13-3/4 x 9-1/8 x 10-5/8")
Net weight	4.2 - 5.4 kg (9.3 - 11.9 lbs.)

40Vmax



TCT Saw Blade, Hex wrench, Battery, Charger, Z: Battery and Charger are sold separately

**Cutting speed 20% UP**

**Max cutting capacity 67 mm**

**Cutting work amount**  
Work volume on a single full battery charge  
**About 140 cuts**

Photo: CS002G

### DCS553Z 150mm (5-7/8") Cordless Metal Cutter

ADT Cordless Metal Cutter, Electric Brake, Soft Start, Dual LED Lights

Li-ion Ah 6.0 | 5.0 | 3.0 | 1.5



Blade Diameter	150 mm (5-7/8")
Max Cutting Capacity	90°: 57.5 mm (2-1/4")
No Load Speed (RPM)	4,200
Sound Power Level	114 dB(A)
Dimensions (L x W x H)	267 x 186 x 250 mm (10-1/2 x 7-3/8 x 9-7/8")
Net weight	2.8 - 3.1 kg (6.1 - 6.8 lbs.)

18V



TCT Saw Blade, Hex Wrench, Safety Goggles, Guide Rule, Z: Battery and Charger are sold separately

### DCS552Z 136mm (5-3/8") Cordless Metal Cutter

Self-Dust Collection Box for Cleaner Work Environment

Li-ion Ah 6.0 | 5.0 | 3.0 | 1.5



Blade Diameter	136 mm (5-3/8")
Max Cutting Capacity	90°: 50.5 mm (2")
No Load Speed (RPM)	3,600
Sound Power Level	113 dB(A)
Dimensions (L x W x H)	348 x 196 x 203 mm (13-3/4 x 7-3/4 x 8")
Net weight	2.4 - 2.7 kg (5.3 - 6.0 lbs.)

18V



TCT Saw Blade, Hex Wrench, Safety Goggles, Z: Battery and Charger are sold separately

### DSC251ZK 25mm (1") Cordless Steel Rod Cutter

Ideal for edge cutting of threaded rods and rebars

Li-ion Ah 6.0 | 5.0 | 3.0 | 1.5



Blade Diameter	110 mm (4-5/16")
Cutting Capacity	Dia.: 10 - 25 mm (3/8" - 1")
No Load Speed (RPM)	2,200
Dimensions (L x W x H)	471 x 137 x 139 mm (18-1/2 x 5-25/64 x 5-15/32")
Net weight	4.0 kg (8.8 lbs.)

18V



Tipped Saw, Dust Bag, Side Grip, Hex Wrench, Battery, Charger, Z: Battery and Charger are sold separately

### 4131 185mm (7-1/4") Metal Cutter

185mm (7-1/4") metal cutter for cutting steel up to 6mm (1/4") in thickness

110V  
4131/B



Continuous rating input	1,100W
Blade Diameter	185 mm (7-1/4")
Capacity	Max cutting: 63mm (2-1/2")
No Load Speed (RPM)	3,500
Overall Length	358 mm (14-1/8")
Net Weight	4.8kg (11.3lbs)
Power supply cord	2.5m (8.2ft)



Carbide-Tipped Saw Blade, Hex Wrench, Safety Goggles

## LC1230 305mm (12") Metal Cutting Saw

Fast cuts in light pipe, angle iron, tubing, conduit and channels

203

110V  
LC1230/B

Continuous rating input	1,750W
Blade Diameter	305 mm (12")
Max Cutting Capacity	90°: 115 mm (4-1/2") 90°: 75 x 150 mm (2-15/16" x 5-7/8") 45°: 90 mm (3-1/2") 45°: 85 x 85 mm (3-5/16" x 3-5/16")
No Load Speed (RPM)	1,300
Dimensions (L x W x H)	516x306x603mm (20-1/4"x12"x23-3/4")
Net Weight	19.3kg (42.5lbs)
Power supply cord	2.5m (8.2ft)

Refer to Cutting Capacity table below



Carbide-Tipped Saw Blade (for mild steel), Socket Wrench, Safety Goggles

## PB002GM201(RM2K) / GZ Cordless Portable Band Saw

40Vmax XGT BL Cordless Portable Band Saw

Li-ion Ah 8.0 5.0 4.0 2.5 2.0



Capacity	Square: 127 x 127 mm (5 x 5") 0 - 3.2 m/min (0 - 630 ft/min)
Blade Speed	
Blade Size	Length: 1,140 mm (45") Width: 13 mm (1/2") Thickness: 0.5 mm (0.02")
Dimensions (L x W x H)	510 x 218 x 314 mm (20 x 8-5/8 x 12-3/8")
Net weight	6.5 - 7.1 kg (14.3 - 15.7 lbs.)

40Vmax



XGT BL XPT



Band Saw Blade, Hex Wrench, Battery, Charger, Z: Battery and Charger are sold separately

## DPB180Z Cordless Portable Band Saw

Light weight and well balanced tool design

430

Li-ion Ah 6.0 5.0 3.0 1.5



Capacity	Round: 120 mm (4-3/4") Rectangular workpiece without stand: 120x120 mm (4-3/4"x4-3/4")
Blade speed	1.4 - 2.7 m/s (275 - 530 ft/min.)
Dimensions (L x W x H)	523x231x313 mm (20-5/8"x9-1/8"x12-3/8")
Net weight	6.8 - 7.1 kg (14.9 - 15.7 lbs)

18V



Hss Bimetal Band Saw Blade (18 Teeth Per Inch), Hex Wrench, Z: Battery and Charger are sold separately

## DPB183Z Cordless Portable Band Saw

18V LXT BL Cordless Portable Band Saw

Li-ion Ah 6.0 5.0 3.0 1.5



Capacity	Round: 66 mm (2-5/8") Square: 66 x 66 mm (2-5/8" x 2-5/8") 0 - 3.2 m/s (0 - 630 ft/min.)
Blade Speed	
Dimensions (L x W x H)	w/ BL1830B / BL1850B / BL1860B: 392x174x242 mm (15-1/2"x6-7/8"x9-1/2")
Net weight	3.6 - 3.9 kg (7.9 - 8.6 lbs.)

18V



Band Saw Blade, Hex Wrench, Battery, Charger, Z: Battery and Charger are sold separately

## DPB184Z Cordless Portable Band Saw

Stable cutting with highly rigid aluminium structure

Li-ion Ah 6.0 5.0 3.0 1.5



Capacity	Round: 51 mm (2") Square: 51 x 51 mm (2" x 2")
Blade Speed	0 - 3.2 m/s (0 - 630 ft/min.)
Dimensions (L x W x H)	w/ BL1830B / BL1850B / BL1860B: 373x162x223 mm (14-3/4"x6-3/8"x8-3/4")
Net weight	3.3 - 3.6 kg (7.3 - 7.9 lbs.)

18V



Band Saw Blade, Hex Wrench, Battery, Charger, Z: Battery and Charger are sold separately

## DPB182Z Cordless Portable Band Saw

18V LXT Li-Ion Cordless Portable Band Saw

Li-ion Ah 6.0 5.0 3.0 1.5



Capacity	Round: 64 mm (2-1/2") Rectangular: 64x64 mm (2-1/2"x2-1/2")
Blade speed	3.2 m/s (630 ft/min.)
Dimensions (L x W x H)	477x197x229 mm (18-3/4"x7-3/4"x9")
Net weight	3.8 - 4.1 kg (8.3 - 9.0 lbs.)

18V



Band Saw Blade, Hex Wrench, Battery, Z: Battery and Charger are sold separately

## 2107FK Portable Band Saw

Large 120 x 120mm (4-3/4" x 4-3/4") capacity with excellent tool balance

303



Continuous rating input	710W
Capacity	Round: 120 mm (4-3/4") Rectangular workpiece Without stand: 120x120mm (4-3/4"x4-3/4")
Blade speed	1.0 - 1.7 m/s (60m (200 ft) - 105m (350 ft) / min)
Dimensions (L x W x H)	508x188x256mm (20"x7-3/8"x10-1/8")
Net Weight	6.3kg (13.9lbs)
Power supply cord	2.5m (8.2ft)



Carbon Steel Band Saw Blade (18 teeth per inch) 1 pc, Hex Wrench

## DSC163ZK Cordless Steel Rod Cutter

18V LXT BL Brushless Cordless 16 mm (5/8") Steel Rod Cutter

Li-ion Ah 6.0 5.0 3.0 1.5



Cutting Capacity	Dia: 3 - 16 mm (1/8" - 5/8")
Cutting Speed (sec)	2.8
Dimensions (L x W x H)	360x108x276 mm (14-1/8"x4-1/4"x10-7/8")
Net weight	6.9 kg (15.2 lbs.)

18V



Wrench, Hex Wrench, Oil, Z: Battery and Charger are sold separately



**DSC191Z Cordless Steel Rod Cutter**

Cutting capacity range of 3 - 20 mm standard rebar



Li-ion Ah 6.0 | 5.0 | 3.0 | 1.5



Cutting Capacity	Dia: 3 - 20 mm (1/8" - 3/4")
Cutting Speed (sec)	6.5
Sound Power Level	90.1 dB(A)
Dimensions (L x W x H)	412x212x284 mm (16-1/5"x8-3/8"x11-1/8")
Net weight	11.1 - 11.2 kg (24.5 - 24.6 lbs.)

18V



Wrench, Hex Wrench, Oil supply, Z: Battery and Charger are sold separately

**DPP200ZK Cordless Hole Puncher**

18V LXT Li-Ion Cordless Hole Puncher

Li-ion Ah 6.0 | 5.0 | 3.0 | 1.5



Capacity	Steel: 20 mm (13/16") Stainless Steel: 20 mm (13/16")
Max Throat Depth	40 mm (1-9/16")
Dimensions (L x W x H)	417x127x315 mm (16-3/8"x5"x12-3/8")
Net weight	10.5 kg (23.2 lbs.)

18V



Punch, Dice, Hex Wrench, Spanner, Bar for fastening nuts, Grip, Oil, Z: Battery and Charger are sold separately

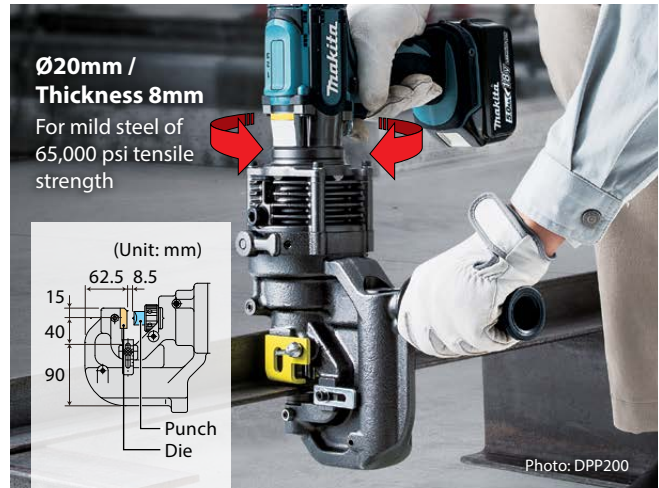

Ø20mm / Thickness 8mm

For mild steel of 65,000 psi tensile strength

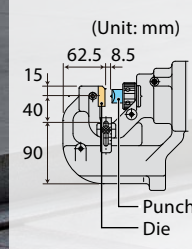
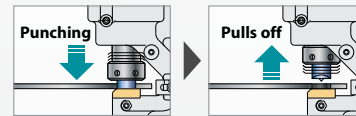

Photo: DPP200



Automatic punch return

After a punching cycle is completed, hydraulic pressure automatically pulls off the punch from workpiece and returns it to the initial position to enable efficient continuous hole punching.

Versatile punch is applicable to a variety of materials: mild steel, stainless steel, channel, aluminum and copper.

Punching capacity



<b>Flat bar</b>	Max: 80mm x t8 (Center punching)
<b>Angle</b>	Min: 40mm x 40mm x t3 Max: 80mm x 80mm x t8
<b>Channel</b>	Min: 75mm x 40mm Max: 100mm x 50mm (Flange punching)

**DLW140Z 355mm (14") Portable Cut-off**

18V X2 (36V) LXT BL 355 mm (14") Toolless Portable Cut-Off

Li-ion Ah 6.0 | 5.0 | 3.0 | 1.5



Wheel Diameter	355 mm (14")
Hole Diameter	25.4 mm (1")
No Load Speed (RPM)	3,800
Max Output	1,300 W
Sound Power Level	115dB
Dimensions (L x W x H)	537x290x640 mm (21-1/8"x11-3/8"x25-1/4")
Net weight	17.2 - 17.8 kg (37.9 - 39.3 lbs.)

18V x2



Abrasive Cut-Off Wheel, Z: Battery and Charger are sold separately

**LW1401 355mm (14") Portable Cut-off**

Powerful 2,200W motor 355mm (14") Portable Cut-off, successor to 2414NB



110V  
LW1401/B



Continuous rating input	2,200W
Wheel Diameter	355 mm (14")
No Load Speed (RPM)	3,800
Capacity at 90°	Round: 127 mm (5") Rectangular: 102x194 mm (4"x7-5/8")
Sound Power Level	110 dB(A)
Dimensions (L x W x H)	500x295x640mm (19-3/4"x11-5/8"x25-1/4")
Net Weight	18.3 kg (40.3 lbs)
Power supply cord	2.5m (8.2ft)

Refer to Cutting Capacity table below



Abrasive cut-off wheel, Socket wrench

**Abrasive cut-off wheel for portable cut-off**

For all ferrous materials (Steel, cast iron) and other hard metals

Size (mm)	Grit	Pc. per pkg.	Part No.
355 x 2.5 x 25.4	A36P	5	B-49448-5
355 x 2.5 x 25.4	A36P	25	B-49448-25



**Features**

1. Thinner



3.0mm

2. Less burred

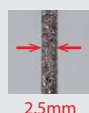

2.5mm

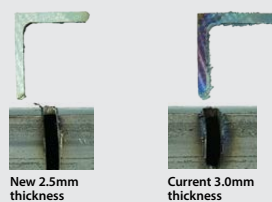

New 2.5mm thickness

Current 3.0mm thickness

**Cutting Capacity**

Form of materials	Miter angle	
	0°	45°
	D: ø127mm (2")	D: ø127mm (2")
	H x W: 102 x 194mm (4" x 7-5/8") 70 x 233mm (2-3/4" x 9-1/8")	H x W: 115 x 103mm (4-1/2" x 4-1/16")
	H x W: 119 x 119mm (4-11/16" x 4-11/16")	H x W: 106 x 106mm (4-3/16" x 4-3/16")
	S x S: 137 x 137mm, T: 10mm (5-3/8" x 5-3/8", 3/8")	S x S: 100 x 100mm, T: 10mm (4" x 4", 3/8")

D: Diameter W: Width H: Height S: Side T: Thickness

## 2416S 405mm (16") Portable Cut-off

405mm (16") blade for more cutting capacity

153



Abrasive Cut-Off Wheel, Socket Wrench

Continuous rating input	1,430W
Wheel Diameter	405 mm (16")
Hole Diameter	25.4mm (1")
No Load Speed (RPM)	2,300
Dimensions (L x W x H)	610x265x535mm (24"x10-3/8"x21")
Net Weight	19.2kg (42.3lbs)
Power supply cord	2.5m (8.2ft)

Refer to Cutting Capacity table below

## DJS161Z 1.6mm Cordless Straight Shear

High cutting capacity: cuts up to 1.6 mm thick mild steel sheet

430

Li-ion Ah 6.0 | 5.0 | 3.0 | 1.5



Capacity	Steel up to 400 N/mm <sup>2</sup> : 1.6 mm Steel up to 600 N/mm <sup>2</sup> : 1.2 mm Aluminum up to 200 N/mm <sup>2</sup> : 2.5 mm
Strokes Per Minute (SPM)	4,300
Dimensions (L x W x H)	362x78x118 mm (14-1/4"x3-1/16"x4-5/8")
Net weight	1.8 - 2.2 kg (4.1 - 4.8 lbs)

18V

LXT

4

Hex Wrench, Thickness Gauge, Z: Battery and Charger are sold separately

## DJS101Z 1.0mm Cordless Metal Shear

Easy curve cutting

430

Li-ion Ah 6.0 | 5.0 | 3.0 | 1.5



Capacity	Steel up to 400 N/mm <sup>2</sup> : 1.0 mm Steel up to 600 N/mm <sup>2</sup> : 0.7 mm Aluminum up to 200 N/mm <sup>2</sup> : 2.5 mm
Strokes Per Minute (SPM)	4,300
Dimensions (L x W x H)	364x78x118 mm (14-3/8"x3-1/16"x4-5/8")
Net weight	1.8 - 2.2 kg (4.0 - 4.7 lbs)

18V

LXT

4

Hex Wrench, Z: Battery and Charger are sold separately

## DJS130Z 1.3mm Cordless Metal Shear

Nibbler without cord expands more operating field

440

Li-ion Ah 6.0 | 5.0 | 3.0 | 1.5



Capacity	Steel up to 400 N/mm <sup>2</sup> : 1.3 mm Steel up to 600 N/mm <sup>2</sup> : 1.0 mm
No Load Speed (RPM)	2,800
Dimensions (L x W x H)	350x80x193 mm (13-3/4"x3-1/8"x7-5/8")
Net weight	2.3 - 2.6 kg (5.0 - 5.8 lbs)

18V

LXT

5

Hex Wrench, Hook, Z: Battery and Charger are sold separately

## JS1601 1.6mm (16Ga) Straight Metal Shear

Minimum outside cutting radius of 250 mm (9-7/8")

459



8

Hex Wrench, Thickness Gauge

Continuous rating input	380W
Capacity	Steel up to 400 N/mm <sup>2</sup> : 1.6mm Steel up to 600 N/mm <sup>2</sup> : 1.2mm Steel up to 800 N/mm <sup>2</sup> : 0.8mm Aluminum up to 200 N/mm <sup>2</sup> : 2.5mm
Min. cutting radius	250mm (9-7/8")
Strokes Per Minute (SPM)	4,500
Dimensions (L x W x H)	320x70x78mm (12-5/8"x2-3/4"x3-1/16")
Net Weight	1.4kg (3.1lbs)
Power supply cord	2.5m (8.2ft)

## JS1300 1.3mm Straight Shear

Low noise level (only 80dB) for quieter operation

419



8

Hex Wrench

Continuous rating input	570W
Capacity	Steel up to 400 N/mm <sup>2</sup> : 1.3 mm Steel up to 600 N/mm <sup>2</sup> : 1.0 mm Steel up to 800 N/mm <sup>2</sup> : 0.5 mm Aluminum up to 200 N/mm <sup>2</sup> : 2.5 mm
Strokes Per Minute (SPM)	0-2,500
Overall Length	302 mm (11-7/8")
Net Weight	1.8 kg (3.9 lbs)
Power supply cord	2.5 m (8.2 ft)

## JS1602 1.6mm (16Ga) Metal Shear

Cuts 16 Ga. Mild Steel and 18 Ga. Stainless

459



8

Hex Wrench

Continuous rating input	380W
Capacity	Steel up to 400 N/mm <sup>2</sup> : 1.6mm Steel up to 600 N/mm <sup>2</sup> : 1.2mm Steel up to 800 N/mm <sup>2</sup> : 0.8mm Aluminum up to 200 N/mm <sup>2</sup> : 2.5mm
Min. cutting radius	30mm (1-3/16")
Strokes Per Minute (SPM)	4,000
Dimensions (L x W x H)	255x74x146mm (10"x2-15/16"x5-3/4")
Net Weight	1.6kg (3.4lbs)
Power supply cord	2.5m (8.2ft)

## JS3201J 3.2mm (10Ga) Metal Shear

Robust design with elastomer coated handle provides easy operation

303



8

Shear Blades Set, Hex Wrench, Thickness Gauge

Continuous rating input	710W
Capacity	Steel up to 400 N/mm <sup>2</sup> : 3.2mm Steel up to 600 N/mm <sup>2</sup> : 2.5mm Steel up to 800 N/mm <sup>2</sup> : 1.5mm Aluminum up to 200 N/mm <sup>2</sup> : 4.0mm
Min. cutting radius	50mm (2")
Strokes Per Minute (SPM)	1,600
Dimensions (L x W x H)	213x90x239mm (8-3/8"x3-1/2"x9-3/8")
Net Weight	3.4kg (7.4lbs)
Power supply cord	2.5m (8.2ft)



**DJN161Z** 1.6mm (16Ga) Cordless Nibbler

Nibbler without cord expands more operating field



Li-ion Ah 6.0 | 5.0 | 3.0 | 1.5



Capacity	Steel up to 400 N/mm <sup>2</sup> : 1.6 mm Steel up to 600 N/mm <sup>2</sup> : 1.2 mm Aluminum up to 200 N/mm <sup>2</sup> : 2.5 mm
Min. cutting radius	Inside edge: 45 mm (1-3/4") Outside edge: 50 mm (2")
Strokes Per Minute (SPM)	1,900
Dimensions (L x W x H)	313x78x189 mm (12-3/8"x3-1/16"x7-7/16")
Net weight	1.9 - 2.3 kg (4.3 - 5.0 lbs)

18V LXT 4

Hex Wrench, Wrench, Punch, Die, Z: Battery and Charger are sold separately

**JN1601** 1.6mm (16Ga) Nibbler

2,200 SPM for faster and smooth cutting



Continuous rating input	550W
Capacity	Steel up to 400 N/mm <sup>2</sup> : 1.6mm Steel up to 600 N/mm <sup>2</sup> : 1.2mm Steel up to 800 N/mm <sup>2</sup> : 0.8mm Aluminum up to 200N/mm <sup>2</sup> : 2.5mm
Min. cutting radius	Outside edge: 50mm (2") Inside edge: 45mm (1-3/4")
Strokes Per Minute (SPM)	2,200
Overall Length	261 mm (10-1/4")
Net Weight	1.6kg (3.6lbs)
Power supply cord	2.0m (6.6ft)

5

Hex Wrench, Wrench, Punch, Die

**JN3201J** 3.2mm (10Ga) Nibbler

Robust design with elastomer coated handle provides easy operation



Continuous rating input	710W
Capacity	Steel up to 400 N/mm <sup>2</sup> : 3.2mm Steel up to 600 N/mm <sup>2</sup> : 2.5mm Steel up to 800 N/mm <sup>2</sup> : 1.0mm Aluminum up to 200N/mm <sup>2</sup> : 3.5mm
Strokes Per Minute (SPM)	1,300
Dimensions (L x W x H)	225x90x254mm (8-7/8"x1-1/2"x10")
Net Weight	3.4kg (7.4lbs)
Power supply cord	2.5m (8.2ft)

1

Punch, Die, Wrench 50, Hex Wrench, Washer

**CA5000X** 118mm (4-5/8") Aluminum Groove Cutter

Developed for cutting grooves in aluminum composite materials



Continuous Rating Input	1,300W
Blade	Type: Cutter blade / TCT saw blade
Max Cutting Capacity with Cutter blade	with Guide rail: 11mm (7/16")
Max Cutting Capacity with TCT Saw blade	with Guide rail: 36mm (1-7/16") without Guide rail: 41mm (1-5/8")
No Load Speed (RPM)	2,200-6,400
Dimension (L x W x H)	346x250x250mm (13-5/8"x9-7/8"x9-7/8")
Net Weight	4.7kg (10.4lbs)
Power Supply Cord	2.5m (8.2ft)

1

Cutter blade, Plate, Hex Wrench 5

# GRINDER

## PRODUCTS



**GA038GZ**

230mm (9") Cordless Angle Grinder

40Vmax XGT BL Cordless 230 mm (9") Angle Grinder, Large Trigger Switch

Li-ion Ah 5.0 | 4.0 | 2.5 | 2.0



Wheel Diameter	230 mm (9")
Hole Diameter	22.23 mm (7/8")
No Load Speed (RPM)	6,600
Dimensions (L x W x H)	w/BL4025: 497 x 250 x 156 mm (19-1/2 x 9-7/8 x 6-1/8") w/BL4040: 509 x 250 x 164 mm (20 x 9-7/8 x 6-1/2")
Net weight	4.6 - 7.4 kg (10.1 - 16.3 lbs.)

40Vmax XGT BL AFT AWS XPT 1

Toolless Wheel Cover, Anti-Vibration Grip, Battery, Charger, Z: Battery and Charger are sold separately

**GA037GZ**

180mm (7") Cordless Angle Grinder

40Vmax XGT BL Cordless 180mm (7") Angle Grinder, Large Trigger Switch

Li-ion Ah 5.0 | 4.0 | 2.5 | 2.0



Wheel Diameter	180 mm (7")
Hole Diameter	22.23 mm (7/8")
No Load Speed (RPM)	7,800
Dimensions (L x W x H)	w/BL4025: 497 x 200 x 156 mm (19-1/2 x 7-7/8 x 6-1/8") w/BL4040: 509 x 200 x 164 mm (20 x 7-7/8 x 6-1/2")
Net weight	4.4 - 5.4 kg (9.7 - 11.9 lbs.)

40Vmax XGT BL AFT AWS XPT 1

Toolless Wheel Cover, Anti-Vibration Grip, Battery, Charger, Z: Battery and Charger are sold separately

**GA051GZ**  
150mm (6") Cordless Angle Grinder

New

40Vmax Cordless Angle Grinder, Anti-Restart Function, Electric Brake, Paddle Switch

Li-ion Ah 8.0 | 5.0 | 4.0 | 2.5 | 2.0



Wheel Diameter	150 mm (6")
Hole Diameter	22.23 mm (7/8")
No Load Speed (RPM)	9,000
Dimensions (L x W x H)	w/BL4025: 398 x 171 x 156 mm (15-5/8 x 6-3/4 x 6-1/8") w/BL4050F: 436 x 171 x 185 mm (17-1/8 x 6-3/4 x 7-1/4")
Net weight	3.1 - 4.7 kg (6.8 - 10.4 lbs.)

40Vmax



XGT BL AFT XPT

Depressed center wheel, Cutting wheel cover attachment, Toolless wheel cover, Lock nut wrench, Battery, Charger, Z: Battery and Charger are sold separately

**GA036GZ / GA035GZ**  
150mm (6") Cordless Angle Grinder

40Vmax XGT BL AFT, Anti-Restart Function, Electric Brake

Li-ion Ah 5.0 | 4.0 | 2.5 | 2.0



Wheel Diameter	150 mm (6")
Hole Diameter	22.23 mm (7/8")
No Load Speed (RPM)	8,500
Dimensions (L x W x H)	w/BL4020 / BL4025: 398 x 171 x 156 mm (15-5/8 x 6-3/4 x 6-1/8") w/BL4040: 410 x 171 x 168 mm (16-1/8 x 6-3/4 x 6-5/8")
Net weight	3.0 - 3.7 kg (6.6 - 8.2 lbs.)

GA036GZ / GA035GZ

40Vmax



XGT BL AFT XPT

Grinding Wheel, Toolless Wheel Cover, Side Grip, Lock Nut Wrench, Battery, Charger, Z: Battery and Charger are sold separately



**GA050GZ**  
125mm (5") Cordless Angle Grinder

New

40Vmax Cordless Angle Grinder, Anti-Restart Function, Electric Brake, Paddle Switch

Li-ion Ah 8.0 | 5.0 | 4.0 | 2.5 | 2.0



Wheel Diameter	125 mm (5")
Hole Diameter	22.23 mm (7/8")
No Load Speed (RPM)	11,000
Dimensions (L x W x H)	w/BL4025: 398 x 140 x 156 mm (15-5/8 x 5-1/2 x 6-1/8") w/BL4050F: 436 x 140 x 185 mm (17-1/8 x 5-1/2 x 7-1/4")
Net weight	3.0 - 5.4 kg (6.6 - 11.9 lbs.)

40Vmax



XGT BL AFT XPT

Depressed center wheel, Cutting wheel cover attachment, Toolless wheel cover, Lock nut wrench, Battery, Charger, Z: Battery and Charger are sold separately



**GA044GD201(RD2J) / GZ**  
125mm (5") Cordless Angle Grinder

40Vmax XGT BL AWS AFT Cordless Angle Grinder, Electric Brake, Paddle Switch, X-LOCK

Li-ion Ah 8.0 | 5.0 | 4.0 | 2.5 | 2.0



Wheel Diameter	125 mm (5")
Hole Diameter	22.23 mm (7/8")
No Load Speed (RPM)	3,000 - 8,500
Dimensions (L x W x H)	w/BL4040: 433 x 140 x 168 mm (17 x 5-1/2 x 6-5/8")
Net weight	3.0 - 4.8 kg (6.6 - 10.6 lbs.)

40Vmax



XGT BL AFT AWS X-LOCK XPT

Band Saw Blade, Hex Wrench, Battery, Charger, Z: Battery and Charger are sold separately

**GA029GZJ / GZ** 125mm (5") Cordless Angle Grinder

40Vmax XGT BL AWS AFT Cordless Angle Grinder, Electric Brake, Paddle Switch

Li-ion Ah 5.0 | 4.0 | 2.5 | 2.0



Wheel Diameter	125 mm (5")
Hole Diameter	22.23 mm (7/8")
No Load Speed (RPM)	3,000 - 8,500
Dimensions (L x W x H)	w/BL4025: 413x140x156 mm (16-1/4"x5-1/2"x6-1/8") w/BL4040: 425x140x168 mm (16-3/4"x5-1/2"x6-5/8")
Net weight	3.0 - 4.5 kg (6.6 - 9.9 lbs.)

40Vmax



XGT BL AFT AWS XPT

Grinding Wheel, Toolless Wheel Cover, Side Grip, Lock Nut Wrench, Battery, Charger, Z: Battery and Charger are sold separately

**GA013GZJ / GZ** 125mm (5") Cordless Angle Grinder

40Vmax XGT BL AFT Cordless Angle Grinder, Electric Brake, Paddle Switch

Li-ion Ah 5.0 | 4.0 | 2.5 | 2.0



Wheel Diameter	125 mm (5")
Hole Diameter	22.23 mm (7/8")
No Load Speed (RPM)	8,500
Dimensions (L x W x H)	w/BL4025: 398x140x156 mm (15-5/8"x5-1/2"x6-1/8") w/BL4040: 410x140x168 mm (16-1/8"x5-1/2"x6-5/8")
Net weight	3.0 - 3.6 kg (6.6 - 7.9 lbs.)

40Vmax



XGT BL AFT XPT

Grinding Wheel, Toolless Wheel Cover, Side Grip, Lock Nut Wrench, Battery, Charger, Z: Battery and Charger are sold separately

**GA023GZJ / GZ** 125mm (5") Cordless Angle Grinder

40Vmax XGT BL AWS AFT Cordless Angle Grinder, Electric Brake, Slide Switch Lock-On

Li-ion Ah 5.0 | 4.0 | 2.5 | 2.0



Wheel Diameter	125 mm (5")
Hole Diameter	22.23 mm (7/8")
No Load Speed (RPM)	3,000 - 8,500
Dimensions (L x W x H)	w/BL4025: 413x140x156 mm (16-1/4"x5-1/2"x6-1/8") w/BL4040: 425x140x168 mm (16-3/4"x5-1/2"x6-5/8")
Net weight	3.0 - 4.4 kg (6.6 - 9.7 lbs.)

40Vmax



XGT BL AFT AWS XPT

Grinding Wheel, Toolless Wheel Cover, Side Grip, Lock Nut Wrench, Battery, Charger, Z: Battery and Charger are sold separately



**GA005GZ 125mm (5") Cordless Angle Grinder**

40Vmax XGT BL AFT Cordless Angle Grinder, Electric Brake, Slide Switch Lock-On

Li-ion Ah 5.0 4.0 2.5 2.0



Wheel Diameter	125 mm (5")
Hole Diameter	22.23 mm (7/8")
No Load Speed (RPM)	8,500
Dimensions (L x W x H)	w/BL4025: 398x140x156 mm (15-5/8"x5-1/2"x6-1/8") w/BL4040: 410x140x168 mm (16-1/8"x5-1/2"x6-5/8")
Net weight	2.9 - 3.6 kg (6.4 - 7.9 lbs.)

**GA028GZJ / GZ 115mm (4-1/2") Cordless Angle Grinder**

40Vmax XGT BL AWS AFT Cordless Angle Grinder, Electric Brake, Paddle Switch

Li-ion Ah 5.0 4.0 2.5 2.0



Wheel Diameter	115 mm (4-1/2")
Hole Diameter	22.23 mm (7/8")
No Load Speed (RPM)	3,000 - 8,500
Dimensions (L x W x H)	w/BL4025: 413x130x156 mm (16-1/4"x5-1/8"x6-1/8") w/BL4040: 425x130x168 mm (16-3/4"x5-1/8"x6-5/8")
Net weight	3.0 - 3.6 kg (6.6 - 7.9 lbs.)

40Vmax



XGT BL AFT



Grinding Wheel, Toolless Wheel Cover / Wheel Cover, Side Handle, Lock Nut Wrench, Battery, Charger, Z: Battery and Charger are sold separately

40Vmax



XGT BL AFT AWS



Grinding Wheel, Toolless Wheel Cover, Side Grip, Lock Nut Wrench, Battery, Charger, Z: Battery and Charger are sold separately



**Auto-start Wireless System**

**Switch on the tool, and Vacuum cleaner is activated**

It has been impossible, but now Vacuum cleaner can be automatically activated by Cordless tools with our newly developed wireless system.



**Bluetooth® AWS connects to power tool with Bluetooth**

The Bluetooth® word mark and logos are registered trademarks owned by the Bluetooth SIG, Inc. and any use of such marks by Makita is under license. Other trademarks and trade names are those of their respective owners.

**ADT**

**Automatic torque Drive Technology** automatically changes the cutting speed according to load conditions for an optimum operation

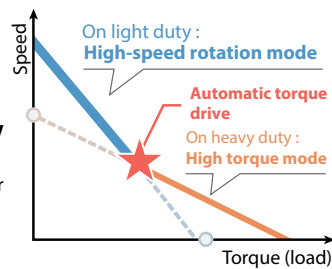

**XLOCK**

Just one click to attach the accessories and easy removal just simply pull the lever



**AFT**

**Active Feedback sensing Technology** Shuts down the tool to protect the user, if the rotation speed suddenly slows down.

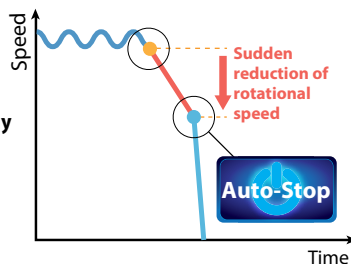

**BL MOTOR**

delivers optimal performance and efficiency even for heavy-duty applications



**Electric brake** maximizes productivity and increases safety for operator

**GA012GZ / GZ 115mm (4-1/2") Cordless Angle Grinder**

40Vmax XGT BL AFT Cordless Angle Grinder, Electric Brake, Paddle Switch

Li-ion Ah 5.0 4.0 2.5 2.0



Wheel Diameter	115 mm (4-1/2")
Hole Diameter	22.23 mm (7/8")
No Load Speed (RPM)	8,500
Dimensions (L x W x H)	w/BL4025: 398x130x156 mm (15-5/8"x5-1/8"x6-1/8") w/BL4040: 410x130x168 mm (16-1/8"x5-1/8"x6-5/8")
Net weight	3.0 - 3.6 kg (6.6 - 7.9 lbs.)



40Vmax



Grinding Wheel, Toolless Wheel Cover, Side Grip, Lock Nut Wrench, Battery, Charger, Z: Battery and Charger are sold separately

**GA022GZ / GZ 115mm (4-1/2") Cordless Angle Grinder**

40Vmax XGT BL AWS AFT Cordless Angle Grinder, Electric Brake, Slide Switch Lock-On

Li-ion Ah 5.0 4.0 2.5 2.0



Wheel Diameter	115 mm (4-1/2")
Hole Diameter	22.23 mm (7/8")
No Load Speed (RPM)	3,000 - 8,500
Dimensions (L x W x H)	w/BL4025: 413x130x156 mm (16-1/4"x5-1/8"x6-1/8") w/BL4040: 425x130x168 mm (16-3/4"x5-1/8"x6-5/8")
Net weight	3.0 - 3.6 kg (6.6 - 7.9 lbs.)



40Vmax



Grinding Wheel, Toolless Wheel Cover, Side Grip, Lock Nut Wrench, Battery, Charger, Z: Battery and Charger are sold separately

**GA004GZ 115mm (4-1/2") Cordless Angle Grinder**

40Vmax XGT BL AFT Cordless Angle Grinder, Electric Brake, Slide Switch Lock-On

Li-ion Ah 5.0 4.0 2.5 2.0



Wheel Diameter	115 mm (4-1/2")
Hole Diameter	22.23 mm (7/8")
No Load Speed (RPM)	8,500
Dimensions (L x W x H)	w/BL4025: 398x130x156 mm (15-5/8"x5-1/8"x6-1/8") w/BL4040: 410x130x168 mm (16-1/8"x5-1/8"x6-5/8")
Net weight	2.9 - 3.5 kg (6.4 - 7.7 lbs.)

40Vmax



Grinding Wheel, Toolless Wheel Cover / Wheel Cover, Side Handle, Lock Nut Wrench, Battery, Charger, Z: Battery and Charger are sold separately

**GA048GZ 100mm (4") Cordless Angle Grinder**

New

40Vmax Cordless Angle Grinder, Anti-Restart Function, Electric Brake, Paddle Switch

Li-ion Ah 5.0 4.0 2.5 2.0



Wheel Diameter	100 mm (4")
Hole Diameter	16 mm (5/8")
No Load Speed (RPM)	11,000
Dimensions (L x W x H)	w/BL4025: 398 x 117 x 156 mm (15-5/8" x 4-5/8" x 6-1/8") w/BL4050F: 436 x 117 x 185 mm (17-1/8" x 4-5/8" x 7-1/4")
Net weight	2.8 - 3.2 kg (6.2 - 11.5 lbs.)

40Vmax



Depressed center wheel, Cutting wheel cover attachment, Toolless wheel cover, Lock nut wrench, Battery, Charger, Z: Battery and Charger are sold separately

**GA042GZ / GZ 100mm (4") Cordless Angle Grinder**

40Vmax XGT BL AWS AFT Cordless Angle Grinder, Electric Brake, Paddle Switch, X-LOCK

Li-ion Ah 5.0 4.0 2.5 2.0



Wheel Diameter	100 mm (4")
Hole Diameter	16 mm (5/8")
No Load Speed (RPM)	3,000 - 8,500
Dimensions (L x W x H)	w/BL4040: 433 x 117 x 162 mm (17 x 4-5/8 x 6-3/8")
Net weight	3.0 - 4.8 kg (6.6 - 10.6 lbs.)

40Vmax



Band Saw Blade, Hex Wrench, Battery, Charger, Z: Battery and Charger are sold separately

**GA027GZ / GZ 100mm (4") Cordless Angle Grinder**

40Vmax XGT BL AWS AFT Cordless Angle Grinder, Electric Brake, Paddle Switch

Li-ion Ah 5.0 4.0 2.5 2.0



Wheel Diameter	100 mm (4")
Hole Diameter	16 mm (5/8")
No Load Speed (RPM)	3,000 - 8,500
Dimensions (L x W x H)	w/BL4025: 413x117x150 mm (16-1/4"x4-5/8"x5-7/8") w/BL4040: 425x117x162 mm (16-3/4"x4-5/8"x6-3/8")
Net weight	2.9 - 3.4 kg (6.4 - 7.5 lbs.)

40Vmax



Grinding Wheel, Toolless Wheel Cover, Side Grip, Lock Nut Wrench, Battery, Charger, Z: Battery and Charger are sold separately

**GA011GD201(RD2J) / GZ 100mm (4") Cordless Angle Grinder**

40Vmax XGT BL AFT Cordless Angle Grinder, Electric Brake, Paddle Switch

Li-ion Ah 5.0 4.0 2.5 2.0



Wheel Diameter	100 mm (4")
Hole Diameter	16 mm (5/8")
No Load Speed (RPM)	8,500
Dimensions (L x W x H)	w/BL4025: 398x117x150 mm (15-5/8"x4-5/8"x5-7/8") w/BL4040: 410x117x162 mm (16-1/8"x4-5/8"x6-3/8")
Net weight	2.8 - 3.4 kg (6.2 - 7.5 lbs.)



40Vmax



Grinding Wheel, Toolless Wheel Cover / Wheel Cover, Side Handle, Lock Nut Wrench, Battery, Charger, Z: Battery and Charger are sold separately

**GA003GM201(RM2J) / GD201(RD2J) / GZ 100mm (4") Cordless Angle Grinder**

40Vmax XGT BL AFT Cordless Angle Grinder, Electric Brake, Slide Switch Lock-On

Li-ion Ah 5.0 4.0 2.5 2.0



Wheel Diameter	100 mm (4")
Hole Diameter	16 mm (5/8")
No Load Speed (RPM)	8,500
Dimensions (L x W x H)	w/BL4025: 398x117x150 mm (15-5/8"x4-5/8"x5-7/8") w/BL4040: 410x117x162 mm (16-1/8"x4-5/8"x6-3/8")
Net weight	2.8 - 3.3 kg (6.2 - 7.3 lbs.)



40Vmax



Grinding Wheel, Toolless Wheel Cover / Wheel Cover, Side Handle, Lock Nut Wrench, Battery, Charger, Z: Battery and Charger are sold separately





## Just One Click

### X LOCK Quick and Effortless Wheel Change System

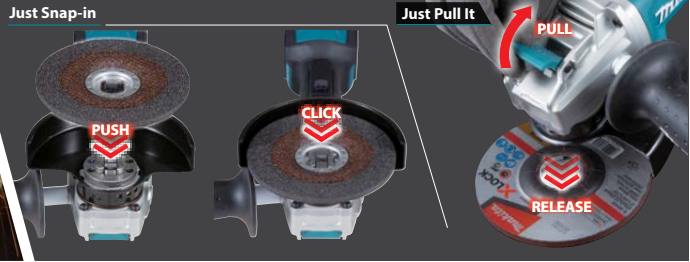

### DGA517RTE / Z 125mm (5") Cordless Angle Grinder

Variable Speed, Anti-Restart Function, Electric Brake, Paddle Switch

Li-ion Ah 6.0 5.0 3.0 1.5



DGA517RTE DGA517Z



Wheel Diameter	125 mm (5")
No Load Speed (RPM)	3,000 - 8,500
Dimensions (L x W x H)	with BL1815N: 368x140x151 mm (14-1/2"x5-1/2"x6") with BL1830B / BL1850B / BL1860B: 382x140x151 mm (15"x5-1/2"x6")
Net weight	2.4 - 3.1 kg (5.2 - 6.7 lbs.)

18V LXT BL ADT AFT XPT

Grinding Wheel, Wheel Cover, Side Grip, Lock Nut Wrench, Battery, Fast Charger, Z: Battery and Charger are sold separately

### DGA508RTE / Z 125mm (5") Cordless Angle Grinder

Excellent performance and User protection

Li-ion Ah 6.0 5.0 3.0 1.5



DGA508RTE DGA508Z



Wheel Diameter	125 mm (5")
No Load Speed (RPM)	8,500
Dimensions (L x W x H)	362x140x151 mm (14-1/4"x5-1/2"x5-15/16")
Net weight	2.35 - 3.83 kg (5.18 - 8.45 lbs)

18V LXT BL ADT AFT XPT

Fast charger, Battery cartridge, Depressed center grinding wheel, Lock nut wrench, Side grip, Z: Battery and Charger are sold separately

### DGA513RTE / Z 125mm (5") Cordless Angle Grinder

Variable Speed, Anti-Restart Function, Electric Brake, Slide Switch Lock-On

Li-ion Ah 6.0 5.0 3.0 1.5



DGA513RTE DGA513Z



Wheel Diameter	125 mm (5")
No Load Speed (RPM)	3,000 - 8,500
Dimensions (L x W x H)	with BL1815N: 368x140x151 mm (14-1/2"x5-1/2"x5-15/16") with BL1830B / BL1850B / BL1860B: 382x140x151 mm (15"x5-1/2"x5-15/16")
Net weight	2.4 - 3.0 kg (5.2 - 6.7 lbs.)

18V LXT BL ADT AFT XPT

Grinding Wheel, Wheel Cover, Side Grip, Lock Nut Wrench, Battery, Fast Charger, Z: Battery and Charger are sold separately

### DGA506RTE / Z 125mm (5") Cordless Angle Grinder

Excellent performance and user protection

Li-ion Ah 6.0 5.0 3.0 1.5



DGA506RTE DGA506Z



Wheel Diameter	125 mm (5")
No Load Speed (RPM)	8,500
Dimensions (L x W x H)	362x140x151 mm (14-1/4"x5-1/2"x5-15/16")
Net weight	2.35 - 3.83 kg (5.18 - 8.45 lbs)

18V LXT BL ADT AFT XPT

Fast charger, Battery cartridge, Depressed center grinding wheel, Lock nut wrench, Side grip, Z: Battery and Charger are sold separately

### DGA469Z 115mm (4-1/2") Cordless Angle Grinder

X-LOCK for toolless accessory changes

Li-ion Ah 6.0 5.0 3.0 1.5



Wheel Diameter	115 mm (4-1/2")
Hole Diameter	22.23 mm (7/8")
Max Wheel Thickness	6 mm (1/4")
No Load Speed (RPM)	3,000 - 8,500
Dimensions (L x W x H)	396x130x147 mm (15-1/2"x5-1/8"x5-3/4")
Net weight	2.5 - 3.1 kg (5.5 - 6.8 lbs.)

18V LXT BL ADT AFT XLOCK XPT

Grinding Wheel, Wheel Cover, Side Grip, Lock Nut Wrench, Battery, Charger, Z: Battery and Charger are sold separately



**DGA419Z 100mm (4") Cordless Angle Grinder**

X-LOCK for toolless accessory changes

Li-ion Ah 6.0 5.0 3.0 1.5



Wheel Diameter	100 mm (4")
Hole Diameter	22.23 mm (7/8")
Max Wheel Thickness	6 mm (1/4")
No Load Speed (RPM)	3,000 - 8,500
Dimensions (L x W x H)	396x117x147mm (15-1/2"x4-5/8"x5-3/4")
Net weight	2.4 - 3.0 kg (5.3 - 6.6 lbs.)

18V



Grinding Wheel, Wheel Cover, Side Grip, Lock Nut Wrench, Battery, Charger, Z: Battery and Charger are sold separately

**DGA417RTE / Z 100mm (4") Cordless Angle Grinder**

Variable Speed, Anti-Restart Function, Electric Brake, Paddle Switch

Li-ion Ah 6.0 5.0 3.0 1.5



Wheel Diameter	100 mm (4")
No Load Speed (RPM)	3,000 - 8,500
Dimensions (L x W x H)	with BL1815N: 368x117x146 mm (14-1/2"x4-5/8"x5-3/4") with BL1830B / BL1850B / BL1860B: 382x117x146 mm (15"x4-5/8"x5-3/4")
Net weight	2.2 - 2.9 kg (4.9 - 6.3 lbs.)

18V



Grinding Wheel, Wheel Cover, Side Grip, Lock Nut Wrench, Battery, Fast Charger, Z: Battery and Charger are sold separately



**Variable speed control dial (3,000 - 8,500 RPM)**

Matches the speed to your application.



	No load speed (RPM)	Cutting / Rough grinding	Grinding / Finish grinding	Rust removal / Paint removal	Stainless steel polishing
1	3,000				✓
2	4,500			✓	✓
3	6,000		✓	✓	✓
4	7,500		✓		
5	8,500	✓			

**DGA408RTJ1 / Z 100mm (4") Cordless Angle Grinder**

Excellent performance and User protection

Li-ion Ah 6.0 5.0 3.0 1.5



Wheel Diameter	100 mm (4")
No Load Speed (RPM)	8,500
Dimensions (L x W x H)	362x117x146 mm (14-1/4"x4-5/8"x5-3/4")
Net weight	2.18 - 2.80 kg (4.81 - 6.17 lbs)

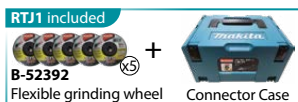

18V



Fast charger, Battery cartridge, Depressed center grinding wheel, Lock nut wrench, Side grip, Z: Battery and Charger are sold separately

**DGA413RTE / Z 100mm (4") Cordless Angle Grinder**

Variable Speed, Anti-Restart Function, Electric Brake, Slide Switch Lock-On

Li-ion Ah 6.0 5.0 3.0 1.5



Wheel Diameter	100 mm (4")
No Load Speed (RPM)	3,000 - 8,500
Dimensions (L x W x H)	with BL1815N: 368x117x147 mm (14-1/2"x4-5/8"x5-3/4") with BL1830B / BL1850B / BL1860B: 382x117x147 mm (15"x4-5/8"x5-3/4")
Net weight	2.2 - 2.8 kg (4.9 - 6.2 lbs.)

18V



Grinding Wheel, Wheel Cover, Side Grip, Lock Nut Wrench, Battery, Fast Charger, Z: Battery and Charger are sold separately

**DGA406RTE / RFE / Z 100mm (4") Cordless Angle Grinder**

Excellent performance and User protection

Li-ion Ah 6.0 5.0 3.0 1.5



Wheel Diameter	100 mm (4")
No Load Speed (RPM)	8,500
Dimensions (L x W x H)	362x117x146 mm (14-1/4"x4-5/8"x5-3/4")
Net weight	2.18 - 2.77 kg (4.81 - 6.12 lbs)



18V



Fast charger, Battery cartridge, Depressed center grinding wheel, Lock nut wrench, Side grip, Z: Battery and Charger are sold separately

**9500NB 100mm (4") Angle Grinder**

Compact and lightweight body works well in close quarters

411

Continuous Rating Input	570W
Wheel Diameter	100 mm (4")
No Load Speed (RPM)	12,000
Overall Length	253 mm (10")
Net Weight	1.9kg (3.5 - 4.3lbs)
Power Supply Cord	2.5m (8.2ft)



4

Depressed Center Wheel, Wheel Cover, Lock Nut Wrench



**GA4031 100mm (4") Angle Grinder**

Powerful 720 W motor with excellent heat resistance

459



Continuous Rating Input	720W
Wheel Diameter	100 mm (4")
No Load Speed (RPM)	11,000
Dimensions (L x W x H)	259x118x104mm (10-1/4"x4-5/8"x4-1/8")
Net Weight	1.7 - 2kg (3.77 - 4.41 lbs)
Power Supply Cord	2.5m (8.2ft)



Depressed Center Wheel, Lock Nut Wrench

**GA4030 100mm (4") Angle Grinder**

Small diameter barrel grip for added comfort

459



Continuous Rating Input	720W
Wheel Diameter	100 mm (4")
No Load Speed (RPM)	11,000
Vibration Level	Surface Grinding: 7.0 m/s <sup>2</sup> Disc Sanding: 2.5 m/s <sup>2</sup> or less
Sound Power Level	96 dB(A)
Dimensions (L x W x H)	266x117x95mm (10-1/2"x4-5/8"x3-3/4")
Net Weight	1.73 - 2.02kg (3.81 - 4.45lbs)
Power Supply Cord	2.5m (8.2ft)



Depressed Center Wheel, Lock Nut Wrench, Side Grip

**9556HPG 100mm (4") Angle Grinder**

Ergonomic paddle switch featured

325

110V  
9556HP/BX



Continuous Rating Input	840W
Wheel Diameter	100 mm (4")
No Load Speed (RPM)	11,000
Sound Power Level	96 dB(A)
Dimensions (L x W x H)	273x118x97mm (10-3/4"x4-5/8"x3-13/16")
Net Weight	1.6 - 2.0 kg (3.6 - 4.5 lbs)
Power Supply Cord	2.5 m (8.2 ft.)



Depressed Center Wheel, Lock Nut Wrench, Side Grip

**9556HNG 100mm (4") Angle Grinder**

Ergonomic slide switch featured

325



Continuous Rating Input	840W
Wheel Diameter	100 mm (4")
No Load Speed (RPM)	11,000
Dimensions (L x W x H)	271x118x97 mm (10-5/8"x4-5/8"x3-13/16")
Net Weight	1.6 - 2.0 kg (3.6 - 4.4 lbs)
Power Supply Cord	2.5 m (8.2 ft.)



Depressed Center Wheel, Side Grip, Wheel Cover, Lock Nut Wrench

**GA4100 100mm (4") Angle Grinder**

New

Anti-Restart Function, Soft Start, Slide Switch, Speed Adjusting Dial



Continuous Rating Input	850W
Wheel Diameter	100 mm (4")
Hole diameter	16 mm (5/8")
Max abrasive wheel thickness	6.4 mm (1/4")
No Load Speed (RPM)	2,800-11,000
Dimensions (L x W x H)	298 x 118 x 105 mm (11-3/4 x 4-5/8 x 4-1/8")
Net Weight	2.1 - 3.0 kg (4.6 - 6.6lbs.)
Power Supply Cord	2.5m (8.2ft)



Depressed center wheel, Lock nut wrench, Cutting wheel cover attachment, Wheel cover, Inner flange, Lock nut, Side grip

**GA4040 100mm (4") Angle Grinder**

"Super Joint System II" developed for effective vibration absorption

325



Continuous Rating Input	1,100W
Wheel Diameter	100 mm (4")
No Load Speed (RPM)	11,000
Sound Power Level	97 dB(A)
Dimensions (L x W x H)	303x117x111 mm (11-7/8"x4-5/8"x4-3/8")
Net Weight	2.2 - 2.5 kg (4.9 - 5.6 lbs)
Power Supply Cord	2.5 m (8.2 ft)



Depressed Center Wheel, Lock Nut Wrench, Side Grip

**GA4050R 100mm (4") Angle Grinder**

100 mm (4") 1,300 W Angle Grinder, Anti-Restart Function, Paddle Switch

260



Continuous Rating Input	1,300W
Wheel Diameter	100 mm (4")
No Load Speed (RPM)	11,000
Vibration Level	Surface Grinding w/ Normal Side Grip: 6.5 m/s <sup>2</sup>
Sound Power Level	102 dB(A)
Dimensions (L x W x H)	325 x 117 x 100 mm (12-3/4 x 4-5/8 x 4-5/16")
Net Weight	2.3 - 2.6 kg (5.1 - 5.7 lbs.)
Power Supply Cord	2.5 m (8.2 ft)



Depressed Center Wheel, Side Grip, Wheel Cover, Lock Nut Wrench

**GA4040C 100mm (4") Angle Grinder**

"Super Joint System II" developed for effective vibration absorption

318



Continuous Rating Input	1,400W
Wheel Diameter	100 mm (4")
No Load Speed (RPM)	2,800-11,000
Sound Power Level	97 dB(A)
Dimensions (L x W x H)	303x117x111mm (11-7/8"x4-5/8"x4-3/8")
Net Weight	2.3 - 2.6kg (5.1 - 5.7lbs)
Power Supply Cord	2.5m (8.2ft)



Depressed Center Wheel, Lock Nut Wrench, Side Grip

**GA4041C** 100mm (4") Angle Grinder

Anti-Restart Function, Soft start, Mechanical Brake, Slide Switch 318



Continuous Rating Input	1,400W
Wheel Diameter	100 mm (4")
No Load Speed (RPM)	2,800-11,000
Dimensions (L x W x H)	325x117x117mm (12-3/4"x4-5/8"x4-5/8")
Net Weight	2.5 - 2.8kg (5.6 - 6.2 lbs)
Power Supply Cord	2.5m (8.2ft)



Depressed Center Wheel, Lock Nut Wrench, Side Grip

**GA4034** 100mm (4") Angle Grinder

Easy to operate paddle switch by the hand gripping motor housing 459



Continuous Rating Input	720W
Wheel Diameter	100 mm (4")
No Load Speed (RPM)	11,000
Vibration Level	Surface Grinding: 7.5 m/s <sup>2</sup> Disc Sanding: 2.5 m/s <sup>2</sup> or less
Sound Power Level	97 dB(A)
Dimensions (L x W x H)	265x118x95mm (10-3/8"x4-5/8"x3-3/4")
Net Weight	1.77 - 2.06kg (3.9 - 4.54 lbs)
Power Supply Cord	2.5m (8.2ft)



Depressed Center Wheel, Lock Nut Wrench, Side Grip

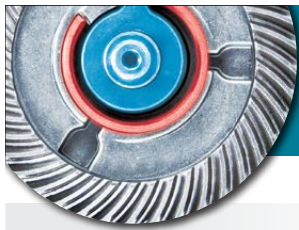

# SJS II

## SUPER JOINT SYSTEM

To suppress vibration to operator

without SJS



SJS II  
SUPER JOINT SYSTEM



### Structure of Super Joint System II

Leaf spring absorbs vibration and relieves shock during operation

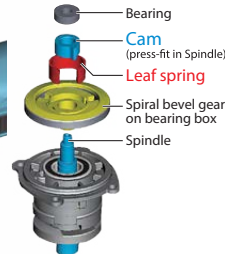
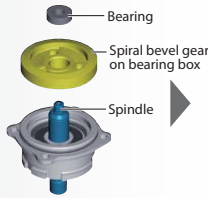

100mm Angle Grinder GA4040

Absorption mechanism of vibration

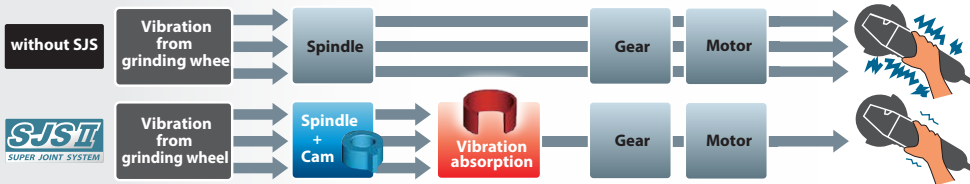

with Brake  
100mm Angle Grinder GA4041C

**9557HNG** 115mm (4-1/2") Angle Grinder

840 W Angle Grinder, Anti-Restart Function, Soft Start, Slide Switch 325



Continuous Rating Input	840W
Wheel Diameter	115 mm (4-1/2")
No Load Speed (RPM)	11,000
Sound Power Level	97 dB(A)
Dimensions (L x W x H)	271x129x106 mm (10-5/8"x5-1/8"x4-3/16")
Net Weight	1.7 - 2.2 kg (3.8 - 5.3 lbs.)
Power Supply Cord	2.5 m (8.2 ft.)



Depressed Center Wheel, Side Grip, Wheel Cover, Lock Nut Wrench

**GA4593X01** 115mm (4-1/2") Angle Grinder

1,900 W SJS II AFT, Anti-Restart Function, Mechanical Brake, Paddle Switch



Continuous rating Input	1,900W
Wheel Diameter	115 mm (4-1/2")
Hole Diameter	22.23 mm (7/8")
No Load Speed (RPM)	2,800 - 11,500
Circumference of grip portion	207 mm (8-1/8")
Cutting depth	26 mm (1")
Dimensions (L x W x H)	349 x 130 x 129 mm (13-3/4 x 5-1/8 x 5-1/8")
Net weight	2.8 - 4.0 kg (6.2 - 8.8 lbs.)



Depressed center wheel, Side grip, Wheel cover, Lock nut wrench



**GA459S 115mm (4-1/2") Angle Grinder**

1,900 W SJS II AFT Angle Grinder, Anti-Restart Function, Soft Start, Paddle Switch



Continuous rating Input	1,900W
Wheel Diameter	115 mm (4-1/2")
Hole Diameter	22.23 mm (7/8")
No Load Speed (RPM)	2,800 - 11,500
Circumference of grip portion	207 mm (8-1/8")
Cutting depth	26 mm (1")
Dimensions (L x W x H)	326 x 130 x 123 mm (12-3/4 x 5-1/8 x 4-7/8")
Net weight	2.6 - 3.8 kg (5.7 - 8.4 lbs.)



Depressed center wheel, Side grip, Wheel cover, Lock nut wrench

**GA5030 125mm (5") Angle Grinder**

Small diameter barrel grip for added comfort



Continuous Rating Input	720W
Wheel Diameter	125 mm (5")
No Load Speed (RPM)	11,000
Sound Power Level	96 dB(A)
Dimensions (L x W x H)	266x138x103mm (10-1/2"x5-7/16"x4-1/16")
Net Weight	1.92 - 3.07kg (4.23 - 6.77lbs)
Power Supply Cord	2.5m (8.2ft)



Depressed Center Wheel, Lock Nut Wrench, Side Grip

**GA5034 125mm (5") Angle Grinder**

Easy to operate paddle switch by the hand gripping motor housing



Continuous Rating Input	720W
Wheel Diameter	125 mm (5")
No Load Speed (RPM)	11,000
Sound Power Level	97 dB(A)
Dimensions (L x W x H)	265x139x103mm (10-3/8"x5-1/2"x4-1/16")
Net Weight	2 - 3.15kg (4.41 - 6.94lbs)
Power Supply Cord	2.5m (8.2ft)



Depressed Center Wheel, Lock Nut Wrench, Side Grip

**GA5100 125mm (5") Angle Grinder**

**New**

Anti-Restart Function, Soft Start, Slide Switch, Speed Adjusting Dial



Continuous Rating Input	850W
Wheel Diameter	125 mm (5")
Hole diameter	22.23 mm (7/8")
Max abrasive wheel thickness	7.2 mm (9/32")
No Load Speed (RPM)	2,800-11,000
Dimensions (L x W x H)	298 x 140 x 111 mm (11-3/4 x 5-1/2 x 4-3/8")
Net Weight	2.2 - 3.2 kg (4.9 - 7.1lbs.)
Power Supply Cord	2.5m (8.2ft)



Depressed center wheel, Lock nut wrench, Cutting wheel cover attachment, Wheel cover, Inner flange, Lock nut, Side grip

**GA5010 125mm (5") Angle Grinder**

Refined design for reduced operator fatigue



**110V**  
**GA5010/B**

Continuous Rating Input	1,050W
Wheel Diameter	125 mm (5")
No Load Speed (RPM)	12,000
Sound Power Level	100 dB(A)
Dimensions (L x W x H)	356x139x112mm (14"x5-1/2"x4-3/8")
Net Weight	2.6 - 3.8kg (5.8 - 8.4lbs)
Power Supply Cord	2.5m (8.2ft)



Depressed Center Wheel, Lock Nut Wrench, Side Grip

**GA5050R 125mm (5") Angle Grinder**

125 mm (5") 1,300 W Angle Grinder, Anti-Restart Function, Paddle Switch



Continuous Rating Input	1,300W
Wheel Diameter	125 mm (5")
No Load Speed (RPM)	11,000
Vibration Level	Surface Grinding w/ Normal Side Grip: 7.5 m/s <sup>2</sup>
Sound Power Level	102 dB(A)
Dimensions (L x W x H)	325 x 140 x 117 mm (12-3/4 x 5-1/2 x 4-5/8")
Net Weight	2.5 - 2.8 kg (5.5 - 6.2 lbs.)
Power Supply Cord	2.5 m (8.2 ft)



Depressed Center Wheel, Side Grip, Wheel Cover, Lock Nut Wrench



**GA5080R 125mm (5") Angle Grinder**

125 mm (5") 1,400 W Angle Grinder, Soft Start, Slide Switch, X-LOCK



Continuous rating input	1,400W
Wheel Diameter	125 mm (5")
Hole Diameter	22.3 mm (7/8")
Max cutting depth	31 mm (1-1/4")
No Load Speed (RPM)	12,000
Dimensions (L x W x H)	309 x 141 x 113 mm (12-1/8 x 5-9/16 x 4-7/16")
Net weight	2.5 - 3.6 kg (5.5 - 7.9 lbs.)
Power supply cord	2.5 m (8.2 ft)



Depressed Center Wheel, Side Grip, Wheel Cover

**GA5091X01** 125mm (5") Angle Grinder

1,900 W SJS II AFT Grinder, Anti-Restart Function, Mechanical Brake, Slide Switch



Continuous rating Input	1,900W
Wheel Diameter	125 mm (5")
Hole Diameter	22.23 mm (7/8")
No Load Speed (RPM)	2,800 - 11,500
Circumference of grip portion	205 mm (8-1/8")
Dimensions (L x W x H)	349 x 140 x 129 mm (13-3/4 x 5-1/2 x 5-1/8")
Net weight	2.8 kg (6.2 lbs.)



Depressed center wheel, Side grip, Wheel cover, Lock nut wrench

**GA6010** 150mm (6") Angle Grinder

Externally accessible brushes for greater serviceability

303



Continuous Rating Input	1,050W
Wheel Diameter	150 mm (6")
No Load Speed (RPM)	10,000
Sound Power Level	101 dB(A)
Dimensions (L x W x H)	356x169x112mm (14"x6-5/8"x4-3/8")
Net Weight	2.7 - 3.1kg (5.9 - 6.9lbs)
Power Supply Cord	2.5m (8.2ft)



Depressed Center Wheel, Lock Nut Wrench, Side Grip

**GA6020C** 150mm (6") Angle Grinder

Trigger Switch with Lock-On Button

253



Continuous Rating Input	1,450W
Wheel Diameter	150 mm (6")
No Load Speed (RPM)	9,000
Sound Power Level	102 dB(A)
Dimensions (L x W x H)	390 x 169 x 120 mm (15-3/8 x 6-5/8 x 4-3/4")
Net Weight	3 - 3.5 kg (6.7 - 7.6 lbs.)
Power Supply Cord	2.5m (8.2ft)



Depressed Center Wheel, Side grip, Wheel Cover, Lock nut wrench

**GA7020** 180mm (7") Angle Grinder

Outstanding durability

204



Continuous Rating Input	2,200W
Wheel Diameter	180 mm (7")
No Load Speed (RPM)	8,500
Sound Power Level	100 dB(A)
Dimensions (L x W x H)	473x200x140mm (18-5/8"x7-7/8"x5-1/2")
Net Weight	5.5 - 6.06kg (12.26 - 13.36 lbs)
Power Supply Cord	2.5m (8.2ft)

Tool does not come with depressed center wheel



Lock Nut Wrench, Side Grip

**GA7060** 180mm (7") Angle Grinder

Developed for heavy duty applications such as foundry grinding

218



Continuous Rating Input	2,200W
Wheel Diameter	180 mm (7")
No Load Speed (RPM)	8,500
Sound Power Level	102 dB(A)
Dimensions (L x W x H)	450x200x144mm (17-3/4"x7-7/8"x5-5/8")
Net Weight	5.38 - 5.89 kg (11.9 - 13lbs)
Power Supply Cord	2.5 m (8.2 ft)

Tool does not come with depressed center wheel



Side grip, Lock nut wrench

**GA7090** 180mm (7") Angle Grinder

New

2,200 W Angle Grinder, Large Trigger Switch



Continuous Rating Input	2,200W
Wheel Diameter	180 mm (7")
Dimensions (L x W x H)	437 x 200 x 144 mm (17-1/4 x 7-7/8 x 5-11/16")
Net Weight	5.1 kg (11 lbs.)



Side grip, Lock nut wrench, Cutting wheel cover attachment

**GA7081** 180mm (7") Angle Grinder

2,700 W Angle Grinder, Large Trigger Switch



Continuous rating input	2,700W
Wheel Diameter	180 mm (7")
No Load Speed (RPM)	8,500
Dimensions (L x W x H)	499 x 200 x 144 mm (19-5/8 x 7-7/8 x 5-5/8")
Net weight	6.1 - 6.6 kg
Power supply cord	2.5 m (8.2 ft)

without Rotatable Handle



Side Grip, Wheel Cover, Lock Nut Wrench

**GA7070X1** 180mm (7") Angle Grinder

2,800 W AFT Angle Grinder, Anti-Restart Function, Soft Start, Electric Brake, Large Trigger Switch



Continuous rating input	2,800W
Wheel Diameter	180 mm (7")
Hole Diameter	22.23 mm (7/8")
No Load Speed (RPM)	8,500
Dimensions (L x W x H)	506 x 200 x 146 mm (20 x 7-7/8 x 5-3/4")
Net weight	6.1-6.6 kg (13.5 - 14.6 lbs.)
Power supply cord	2.5 m (8.2 ft)



Side Grip, Wheel Cover, Lock Nut Wrench



**GA9060 230mm (9") Angle Grinder**

Developed for heavy duty applications such as foundry grinding

218



Continuous Rating Input	2,200W
Wheel Diameter	230 mm (9")
No Load Speed (RPM)	6,600
Sound Power Level	102 dB(A)
Dimensions (L x W x H)	450x250x144mm (17-3/4"x9-7/8"x5-5/8")
Net Weight	5.50 - 7.86kg (12.1 - 17.3 lbs)
Power Supply Cord	2.5 m (8.2 ft)

Tool does not come with depressed center wheel



Side grip, Lock nut wrench

**GA9020 230mm (9") Angle Grinder**

Outstanding durability

204



Continuous Rating Input	2,200W
Wheel Diameter	230 mm (9")
No Load Speed (RPM)	6,000
Sound Power Level	100 dB(A)
Dimensions (L x W x H)	473x249x140mm (18-5/8"x9-3/4"x5-1/2")
Net Weight	5.76 - 8.05kg (12.7 - 17.8 lbs)
Power Supply Cord	2.5m (8.2ft)

Tool does not come with depressed center wheel



Lock Nut Wrench, Side Grip

**GA9090 230mm (9") Angle Grinder**

New

2,200 W Angle Grinder, Large Trigger Switch



Continuous Rating Input	2,200W
Wheel Diameter	230 mm (9")
Dimensions (L x W x H)	437 x 250 x 144 mm (17-1/4 x 9-7/8 x 5-11/16")
Net Weight	5.3 kg (11.6 lbs.)



Side grip, Lock nut wrench, Cutting wheel cover attachment

**GA9081 230mm (9") Angle Grinder**

2,700 W Angle Grinder, Large Trigger Switch



Continuous rating input	2,700W
Wheel Diameter	230 mm (9")
No Load Speed (RPM)	6,600
Dimensions (L x W x H)	499 x 250 x 144 mm (19-5/8 x 9-7/8 x 5-5/8")
Net weight	6.3 - 8.4 kg
Power supply cord	2.5 m (8.2 ft)

without Rotatable Handle



Side Grip, Wheel Cover, Lock Nut Wrench

**GA9070X1 230mm (9") Angle Grinder**

2,800 W AFT Angle Grinder, Anti-Restart Function, Soft Start, Electric Brake, Large Trigger Switch



Continuous rating input	2,800W
Wheel Diameter	230 mm (9")
Hole Diameter	22.23 mm (7/8")
No Load Speed (RPM)	6,600
Dimensions (L x W x H)	506 x 250 x 146 mm (20 x 9-7/8 x 5-3/4")
Net weight	6.3-8.5 kg (13.9 - 18.7 lbs.)
Power supply cord	2.5 m (8.2 ft)



Side Grip, Wheel Cover, Lock Nut Wrench

**DGD800Z 8mm (1/4") Cordless Die Grinder**

Now free from cord for easy job site portability

430

Li-ion Ah 6.0 5.0 3.0 1.5



Capacity	Collet : 3 mm - 8 mm
Wheel Diameter	38 mm (1-1/2")
No Load Speed (RPM)	26,000
Dimensions (L x W x H)	402x82x118 mm (15-3/4"x3-1/4"x4-5/8")
Net weight	1.7 - 2.2 kg (3.8 - 4.9 lbs)

18V LXT 3

Collet Cone, Wrench, Z: Battery and Charger are sold separately.

**GD0600 6mm (1/4") Die Grinder**

Small-circumference housing for easy handling

325



110V GD0600/B

Continuous Rating Input	400W
Capacity	Collet: 3,6mm or 1/8", 1/4"
Wheel Diameter	38 mm (1-1/2")
No Load Speed (RPM)	25,000
Dimensions (L x W x H)	358x82x82mm (14-1/8"x3-1/4"x3-1/4")
Net Weight	1.7 - 1.87kg (3.77 - 4.12 lbs)
Power Supply Cord	2.5m (8.2ft)



Wrench (2pcs)

**GD0601 6mm (1/4") Die Grinder**

Small-circumference housing for easy handling

325



Continuous Rating Input	400W
Capacity	Collet: 3,6mm or 1/8", 1/4"
Wheel Diameter	38 mm (1-1/2")
No Load Speed (RPM)	25,000
Dimensions (L x W x H)	359x82x82mm (14-1/8"x3-1/4"x3-1/4")
Net Weight	1.68 - 1.84kg (3.7 - 4.06 lbs)
Power Supply Cord	2.5m (8.2ft)



Wrench (2pcs)

## GD0602 6mm (1/4") Die Grinder

Compact body with short nose

325



Continuous Rating Input	400W
Capacity	Collet: 3,6,8mm or 1/8",1/4"
Wheel Diameter	38 mm (1-1/2")
No Load Speed (RPM)	25,000
Dimensions (L x W x H)	264x82x82mm (10-3/8"x3-1/4"x3-1/4")
Net Weight	1.4kg (3.2lbs)
Power Supply Cord	2.5m (8.2ft)



5

Wrench (2pcs)

## GD0603 6mm (1/4") Die Grinder

Easy handling, Compact Die grinder with new aesthetic design

64



110V  
GD0603/B

Continuous Rating Input	240W
Capacity	Collet: 6mm or 1/4"
Max Wheel Diameter	19mm
No Load Speed (RPM)	28,000
Diameter of grip	65mm
Circumference of Grip	203mm
Dimensions (L x W x H)	289x64x67mm (11-3/8"x2-1/2"x2-5/8")
Net Weight	0.97kg (2.1lbs)
Power Supply Cord	2.5m (8.2ft)



6

Spanner 10 (x2), Wheel points

## 906/B 6mm (1/4") Die Grinder

Lightweight for controlled Grinding operations

64



110V

Continuous Rating Input	240W
Capacity	Collet: 6 mm or 1/4"
No Load Speed (RPM)	25,000
Overall Length	283 mm (14")
Net Weight	0.94 kg (2.1 lbs)
Power Supply Cord	2.5 m (8.2 ft)



10

Wheel Point (2pcs.), Wrench (2pcs.), Dressing Stone

## GD0800C 8mm (1/4") Die Grinder

High-speed die grinder with max. 8mm collet capacity

318



Continuous Rating Input	750W
Capacity	Collet: 3,6,8mm or 1/8",1/4"
Wheel Diameter	25 mm (1")
No Load Speed (RPM)	7,000-28,000
Dimensions (L x W x H)	371x75x75mm (14-5/8"x2-15/16"x2-15/16")
Net Weight	1.88kg (4.14lbs)
Power Supply Cord	2.5m (8.2ft)

Tool does not come with depressed center wheel



Wrench x2

## GS5000 125mm (5") Straight Grinder

"Tool-less" guard cap removal for more convenient wheel changes

204



Continuous Rating Input	750W
Wheel Diameter	125 mm (5")
Hole Diameter	12.7,20mm (1/2,13/16")
No Load Speed (RPM)	5,600
Dimensions (L x W x H)	590x189x116mm (23-1/4"x7-7/16"x4-9/16")
Net Weight	5.0 - 5.2kg (11.0 - 11.5 lbs)
Power Supply Cord	2.5m (8.2ft)



1



## GB602 150mm (6") Bench Grinder

Steady tool maintenance from this light, yet stable performer



Continuous Rating Input	250W
Wheel Diameter	150 mm (6")
Wheel Width	16mm (5/8")
Hole Diameter	12.7mm (1/2")
H.P.	1/3
No Load Speed (RPM)	2,850 (50Hz) / 3,450 (60Hz)
Dimensions (L x W x H)	375x348x286mm (14-49/64"x 13-45/64"x11-17/64")
Net Weight	9.5kg



1

Eye Shield, Protection Glasses, Grinding wheel x 2

## GB801 205mm (8") Bench Grinder

Steady tool maintenance from this light, yet stable performer



Continuous Rating Input	550W
Wheel Diameter	205 mm (8")
Wheel Width	19mm (3/4")
Hole Diameter	15.88mm (5/8")
H.P.	3/4
No Load Speed (RPM)	2,850 (50Hz) / 3,450 (60Hz)
Dimensions (L x W x H)	395x265x333mm (15-9/16"x 10-7/16"x13-7/64")
Net Weight	19.91 - 19.65kg (43.89 - 43.28lbs)



1

Eye Shield, Protection Glasses, Grinding wheel x 2



# SAWING

## PRODUCTS



### LS003GZ 305mm (12") Cordless Slide Compound Miter Saw

LED light with ink line aligning function

Li-ion Ah 8.0 5.0 4.0 2.5 2.0



Blade Diameter	305 mm (12")
Miter Angle	60° L / 60° R
Bevel Angle	48° L / 48° R
Max Cutting Capacity	90° Miter: 107 x 363 mm (4-1/4 x 14-1/4") 90° Miter: 92 x 382 mm (3-5/8 x 15") 45° Miter, L/R: 107 x 255 mm (4-1/4 x 10") 45° Miter, L/R: 92 x 268 mm (3-5/8 x 10-1/2")
No Load Speed (RPM)	3,600
Dimensions (L x W x H)	898 x 690 x 725 mm
Net weight	30.0 - 30.6 kg (66.1 - 67.5 lbs.)

40Vmax



XGT BL AWS DXT

TCT Saw Blade, Dust Bag, Triangular Rule, Vertical Vise, Hex Wrench, Battery, Charger, Z: Battery and Charger are sold separately

### LS004GZ 260mm (10-1/4") Cordless Slide Compound Miter Saw

LED light with ink line aligning function

Li-ion Ah 8.0 5.0 4.0 2.5 2.0



Blade Diameter	260 mm (10-1/4")
Miter Angle	60° L / 60° R
Bevel Angle	48° L / 48° R
Max Cutting Capacity	90° Miter: 68 x 310 mm (2-11/16 x 12-1/4") 91 x 279 mm (3-5/8 x 11") 45° Miter, L/R: 68 x 218 mm (2-11/16 x 8-5/8") 91 x 197 mm (3-5/8 x 7-3/4")
No Load Speed (RPM)	3,600
Dimensions (L x W x H)	805 x 644 x 660 mm
Net weight	26.6 - 27.2 kg (58.6 - 60.0 lbs.)

40Vmax



XGT BL AWS DXT

TCT Saw Blade, Dust Bag, Triangular Rule, Vertical Vise, Hex Wrench, Wireless unit set, Battery, Charger, Z: Battery and Charger are sold separately

### LS002GZ 216mm (8-1/2") Cordless Slide Compound Miter Saw

More efficient dust extraction

Li-ion Ah 5.0 4.0 2.5 2.0



Blade Diameter	216 mm (8-1/2")
Miter Angle	60° L / 60° R
Bevel Angle	48° L / 48° R
Max Cutting Capacity	90° Miter: 70 x 312 mm (2-3/4 x 12-1/4") 27-5/8 x 21-3/4 x 22"
No Load Speed (RPM)	4,800
Dimensions (L x W x H)	702 x 551 x 557 mm
Net weight	16.4 - 17.0 kg (36.2 - 37.6 lbs.)

40Vmax



XGT BL AWS DXT

TCT Saw Blade, Dust Bag, Triangular Rule, Vertical Vise, Hex Wrench, Battery, Charger, Z: Battery and Charger are sold separately

### LS0714 190mm (7-1/2") Slide Compound Saw

Compact and Lightweight for Increased Jobsite Portability

303



Continuous Rating Input	1,010W
Max Cutting Capacity	90°: 52 x 300 mm (2-1/16" x 11-3/4") 45°: 52 x 212 mm (2-1/16" x 8-3/8")
Blade Diameter	190 mm (7-1/2")
No Load Speed (RPM)	6,000
Sound Power Level	101 dB(A)
Dimensions (L x W x H)	670x430x458mm (26-3/8"x17"x18")
Net Weight	13.1 kg (28.9 lbs)
Power Supply Cord	2.5m (8.2ft)



T.C.T Saw Blade, Socket Wrench, Dust Bag, Holder Set, Vertical Vise, Triangular Rule

### LS1018L 260mm (10-1/4") Slide Compound Saw

Bevel cutting 45 degrees left and right

JM23000123



Continuous Rating Input	1,430W
Max Cutting Capacity	90°: 91 x 305 mm (3-5/8" x 12") 45°: 91 x 215 mm (3-5/8" x 8-1/2")
Blade Diameter	255 - 260 mm (10 - 10-1/4")
No Load Speed (RPM)	4,300
Sound Power Level	103 dB(A)
Dimensions (L x W x H)	825x536x633mm (32-1/2"x21-1/8"x25")
Net Weight	20.6kg (45.4lbs)
Power Supply Cord	2.5m (8.2ft)



Carbide - Tipped Saw Blade, Vertical Vise, Socket Wrench, Triangular Rule, Dust Bag, Holder Assembly

### LS1019L 260mm (10-1/4") Slide Compound Miter Saw

260 mm (10-1/4") 1,510 W DXT Dual Slide Compound Miter Saw, Laser

153



Continuous Rating Input	1,510W
Blade Diameter	260 mm (10-1/4")
Bevel Angle	48° L / 48° R
Miter Angle	60° L / 60° R
Max Cutting Capacity (Bevel/Miter)	90°/90°: 68 / 310 mm (2-11/16" x 12-1/4") 90°/90°: 91 / 279 mm (3-5/8" x 11") 90°/45° L/R: 68 / 218 mm (2-11/16" x 8-5/8") 90°/45° L/R: 91 / 197 mm (3-5/8" x 7-3/4")
No Load Speed (RPM)	3,200
Dimensions (L x W x H)	805x644x660 mm (31-3/4"x25-3/8"x26")
Net Weight	26.3 kg (57.9 lbs.)
Power Supply Cord	2.5 m (8.2 ft.)



Dust Bag, Triangular Rule, Vertical Vise, Socket Wrench, Hex Wrench, Holder

**LS1110F 255-260 mm (10 - 10-1/4") Slide Compound Miter Saw**

**New**

Cuts up to 310 mm (12-1/4") at 90° and 220 mm (8-5/8") at 45°



Continuous Rating Input	1,450W
Max Cutting Capacity	Bevel 0° / Miter 0°: 91 x 310mm, Bevel 0° / Miter 45°LR: 91 x 220mm, Bevel 45°L / Miter 0°: 50 x 310mm Bevel 45°L / Miter 45°LR: 50 x 220mm 255 - 260 mm, Bevel 2°R / Miter 0°: 85 x 310mm
No Load Speed (RPM)	4,500
Dimensions (L x W x H)	745 x 497 x 565 mm (29-1/4 x 19-1/2 x 22-1/4")
Net Weight	16.4 kg (36.2 lbs.)
Power Supply Cord	2.0 m (6.6 ft)



Carbide-tipped saw blade, Vertical vise, Dust bag, Hex wrench



LED job light with cut line guide function

Miter at 0°	45° Bevel Cut at 45° left	Cross Cut	5° right
<p>With a 20mm (3/4") auxiliary wood fence</p>	<p>45x265 (1-3/4" x 10-3/8") 40 x 300 mm (1-9/16" x 11-3/4")</p>	<p>60x265 (2-3/8" x 10-3/8") 52 x 300 mm (2-1/16" x 11-3/4")</p>	<p>40 x 300 mm (1-9/16" x 11-3/4")</p>
<p>With a 15mm (3/5") auxiliary wood fence</p>	<p>45x185 (1-3/4" x 7-1/4") 40 x 212 mm (1-9/16" x 8-3/8")</p>	<p>60x185 (2-3/8" x 7-1/4") 52 x 212mm (2-1/16" x 8-3/8")</p>	-
<p>With a 10mm (3/8") auxiliary wood fence</p>	-	<p>60x145 (2-3/8" x 5-3/4") 52 x 163 mm (2-1/16" x 6-3/8")</p>	-

**LS1219L 305mm (12") Slide Compound Miter Saw**

305 mm (12") 1,800 W Slide Compound Miter Saw, Laser

153



Continuous Rating Input	1,800W
Blade Diameter	305 mm (12")
Bevel Angle	48° L / 48° R
Miter Angle	60° L / 60° R
Max Cutting Capacity	90°: 107 x 363 mm (4-1/4" x 14-1/4") 45°: 107 x 255 mm (4-1/4" x 10")
No Load Speed (RPM)	3,200
Dimensions (L x W x H)	898x644x725mm (35-1/4"x25-3/8"x28-1/2")
Net Weight	29.3 kg (64.6 lbs)
Power Supply Cord	2.5 m (8.2 ft.)



Vertical Vise, Hex Wrench, Triangular Rule, Dust Bag

**LS1040 260mm (10-1/4") Compound Miter Saw**

Robust construction for consistently accurate cuts

153



Continuous Rating Input	1,650W
Max Cutting Capacity	90°: 90.5 x 95 mm (3-9/16" x 3-3/4") 45°: 90.5 x 67 mm (3-9/16" x 2-5/8")
Blade Diameter	260 mm (10-1/4")
No Load Speed (RPM)	4,600
Sound Power Level	106 dB(A)
Dimensions (L x W x H)	530x476x532mm (20-7/8"x18-3/8"x21")
Net Weight	12.4kg (27.3lbs)
Power Supply Cord	2.5m (8.2ft)

Tool does not come with saw blade



Carbide-tipped saw blade, Vise assembly, Dust bag, Socket wrench 13, Triangular rule, Sub plate assembly, Holder x 2

**LS1440 355mm (14") Miter Saw**

Clean miter cutting up to 45 degrees, right or left

153



Continuous Rating Input	1,380W
Max Cutting Capacity	90°: 122 x 152 mm (4-13/16" x 6") 45°: 122 x 115 mm (4-13/16" x 4-1/2")
Blade Diameter	355 mm (14")
No Load Speed (RPM)	3,200
Dimensions (L x W x H)	530x596x435mm (20-7/8"x23-1/2"x17-1/8")
Net Weight	34.2kg (75.4lbs)
Power Supply Cord	2.5m (8.2ft)

Tool does not come with saw blade



Socket Wrench, Vise Assembly, Dust Bag, Holder Set

**LH1201FL 305mm (12") Table Top Miter Saw**

Max. cutting width up to 200mm

JM29000123



Continuous Rating Input	1,650W
Blade Diameter	305 mm (12")
Miter Angle	47° L / 52° R
Bevel Angle	45° L
Max Cutting Capacity	90°: 62x200mm (2-7/16"x7-7/8") 90°: 95x155mm (3-3/4"x6-1/8") 45° Miter, L/R: 62x135mm (2-7/16"x5-1/8") 45° Miter, L/R: 95x110mm (3-3/4"x4-5/16") 90°, Table saw: 52mm (2-1/16")
No Load Speed (RPM)	3,800
Sound Power Level	106 dB(A)
Table Size (W x L)	307 x 465 mm (12-1/8" x 18-1/4")
Net Weight	20.9 kg (46.1 lbs)
Power Supply Cord	2.5 m (8.2 ft)



Carbide-tipped saw blade, Vertical vise, Dust bag, Guide rule, Ring, Triangular rule, Push stick, Blade cover, Socket wrench, Holder set



**MLT100 260mm (10-1/4") Table Saw**

Sliding left extension sub-table is provided

JM23000123



JM27000300



Continuous Rating Input	1,500W
Max Cutting Capacity	0°: 93 mm (3-5/8") 45°: 64 mm (2-1/2")
Blade Diameter	260 mm (10-1/4")
No Load Speed (RPM)	4,300
Dimensions (L x W x H)	726x984x333mm (28-1/2"x38-3/4"x13-1/8")
Net Weight	34.1kg (75.2lbs)
Power Supply Cord	2.5m (8.2ft)

\*Comes with JM27000300 (1 unit)



TCT Saw Blade, Rip Fence, Miter Gauge, Wrenches, Push Stick, Triangular Rule

**2712 315mm (12-3/8") Table Saw**

315mm table saw with induction motor



Max Cutting Capacity	0°: 85 mm (3-3/8") 45°: 58 mm (2-1/4")
Blade Diameter	315 mm (12-3/8")
No Load Speed (RPM)	50Hz: 2,950 60Hz: 3,400
Bevel Cutting Capacity	0 - 45
Dimensions (L x W x H)	1,670x700x810mm (65-3/4"x27-1/2"x32")
Net Weight	54kg (118.9lbs)
Power Supply Cord	3.0m (9.8ft)



Tct Saw Blade, Rip Fence, Miter Gauge, Wrenches, Push Stick, Ring

**SJ401 Scroll Saw**

Bevel cuts up to 45 degrees to the left and 15 degrees to the right

375009-001



Continuous Rating Input	50W
Capacity	Thickness of cut: 50mm (2") Throat: 406mm (16")
Length of Stroke	18 mm (11/16")
Strokes Per Minute (SPM)	400-1,600
Overall Length	600 mm (23-5/8")
Net Weight	14.1kg (31lbs)



Saw Blades 6, Hex Wrench, Blade Change Rod

**LB1200F 305mm (12") Band Saw**

305mm Band Saw with high cutting efficiency



Continuous Rating Input	900W
Capacity	Thickness of cut: 165mm (6-1/2") Throat: 305mm (12")
Blade Speed High	(50Hz)800 (60Hz)1,000m (50Hz)2,624 (60Hz) 3,280ft / min
Blade Speed Low	(50Hz)400 (60Hz)500m (50Hz)1,312 (60Hz) 1,640ft / min
Dimensions (L x W x H)	615x775x1,600mm (24-1/4"x30-1/2"x63")
Net Weight	82kg (181.2lbs)
Power Supply Cord	2.5m (8.2ft)



Saw Blades 6, Hex Wrench, Blade Change Rod

**CIRCULAR SAW**

**PRODUCTS**



**SP001GZ 165mm (6-1/2") Cordless Plunge Cut Saw**

BL motor delivers 4,900 RPM for fast cutting and ripping

Li-ion Ah 8.0 | 5.0 | 4.0 | 2.5 | 2.0



Blade Diameter	165 mm (6-1/2")
Max Cutting Capacity	0°: 56 mm (2-3/16") 45°: 40 mm (1-9/16") 48°: 38 mm (1-1/2")
No Load Speed (RPM)	2,500 - 4,900
Sound Power Level	100 dB(A)
Dimensions (L x W x H)	347 x 221 x 271 mm (13-5/8 x 8-3/4 x 10-5/8")
Net weight	4.4 - 5.0 kg (9.7 - 11.0 lbs.)



TCT Saw Blade, Hex Wrench, Battery, Charger, Z: Battery and Charger are sold separately

**Cutting Performance**

40 x 600mm Kitchen board (Laminated wood) cutting, Bevel angle: 0°

**150 cuts** (with BL4040\*)

Photo: SP001G



Max Cutting Capacity **56mm**

**DSP600Z** 165mm (6-1/2") Cordless Plunge Cut Saw

18V X2 (36V) LXT BL Cordless 165 mm (6-1/2") Plunge Cut Saw

Li-ion Ah 6.0 5.0 3.0 1.5



Blade Diameter	165 mm (6-1/2")
Max Cutting Capacity	90°: 56 mm (2-3/16") 45°: 40 mm (1-9/16") 48°: 38 mm (1-1/2")
No Load Speed (RPM)	2,500 - 6,300
Sound Power Level	103 dB(A)
Dimensions (L x W x H)	346x241x272 mm (13-5/8"x9-1/2"x10-3/4")
Net weight	4.4 - 5.1 kg (9.8 - 11.2 lbs)

18V x2



Blade, Blade Cover, Base Cover, Hex Wrench, Z: Battery and Charger are sold separately

**DSP601Z** 165mm (6-1/2") Cordless Plunge Cut Saw

18V X2 (36V) LXT BL Cordless 165 mm (6-1/2") Plunge Cut Saw

Li-ion Ah 6.0 5.0 3.0 1.5



Blade Diameter	165 mm (6-1/2")
Max Cutting Capacity	90°: 56 mm (2-3/16") 45°: 40 mm (1-9/16") 48°: 38 mm (1-1/2")
No Load Speed (RPM)	2,500 - 6,300
Sound Power Level	103 dB(A)
Dimensions (L x W x H)	346x241x272 mm (13-5/8"x9-1/2"x10-3/4")
Net weight	4.4 - 5.1 kg (9.8 - 11.2 lbs)

18V x2



Blade, Blade Cover, Base Cover, Hex Wrench, Z: Battery and Charger are sold separately

**SP6000J** 165mm (6-1/2") Plunge Cut Circular Saw

Light duty model with continuous input 450W

303 mm



Continuous Rating Input	1,300W
Blade Diameter	165 mm (6-1/2")
Max Cutting Capacity	90°: 56 mm (2-3/16") 45°: 40 mm (1-9/16") 48°: 38 mm (1-1/2")
No Load Speed (RPM)	2,200 - 6,400
Dimensions (L x W x H)	341x225x250mm (13-3/8"x8-7/8"x9-7/8")
Net Weight	4.1kg (9lbs)
Power Supply Cord	2.5m (8.2ft)



Carbide-tipped saw blade. Hex wrench

**HS009GZ** 235mm (9-1/4") Cordless Circular Saw

40Vmax XGT BL AWS Cordless 235 mm (9-1/4") Magnesium Circular Saw

Li-ion Ah 8.0 5.0 4.0 2.5 2.0



Wheel Diameter	235 mm (9-1/4")
Hole Diameter	15.88 / 25 / 25.4 / 30 mm (5/8 / 1 / 1 / 1-3/16")
Blade Body Thickness	1.4 - 1.8 mm
Max Cutting Capacity	0°: 85 mm (3-3/8") 45°: 61 mm (2-3/8") 60°: 44 mm (1-3/4")
No Load Speed (RPM)	4,000
Max Output	1,600 W
Dimensions (L x W x H)	413 x 196 x 316 mm (16-1/4 x 7-3/4 x 12-1/2")
Net weight	5.1 - 5.7 kg (11.2 - 12.6 lbs.)

40Vmax



TCT Saw Blade, Sub Base, Hex Wrench, Battery, Charger, Z: Battery and Charger are sold separately



Photo: HS009G

**Lightweight & high power**

Predecessor AC Model **6.7 kg**

HS009G/ HS010G **5.7/ 6.1 kg** (with BL4050F)

**Magnesium diecast base**

(HS009G only) having direct compatibility with Guide rail

**Twin LED Job light**

Bevel cuts up to **1° left and 60° right.**



**Work amount on a single full battery charge** **120 cuts**

Model: HS009G  
Oak wood (Thickness: 80mm / Width: 300mm / Bevel angle: 0°) with BL4050F



**HS010GZ** 235mm (9-1/4") Cordless Circular Saw

40Vmax XGT BL AWS Cordless 235 mm (9-1/4") Circular Saw

Li-ion Ah 8.0 5.0 4.0 2.5 2.0



Wheel Diameter	235 mm (9-1/4")
Hole Diameter	25 / 25.4 / 30 mm (1 / 1 / 1-3/16")
Blade Body Thickness	1.4 - 1.8 mm
Max Cutting Capacity	0°: 85 mm (3-3/8") 45°: 61 mm (2-3/8") 60°: 41 mm (1-5/8")
No Load Speed (RPM)	4,000
Max Output	1,600 W
Dimensions (L x W x H)	430 x 224 x 316 mm (17 x 8-7/8 x 12-1/2")
Net weight	5.5 - 6.1 kg (12.1 - 13.4 lbs.)

40Vmax



TCT Saw Blade, Guide Rule, Hex Wrench, Battery, Charger, Z: Battery and Charger are sold separately





**HS003GM201 (RM2) / GZ**  
190mm / 185mm (7-1/2" / 7-1/4") Cordless Circular Saw

BL motor delivers 6,000 RPM for fast cutting

Li-ion Ah 8.0 5.0 4.0 2.5 2.0



Blade Diameter	190 / 185 mm (7-1/2" / 7-1/4")
Max Cutting Capacity	90°: 68.5 / 66 mm (2-11/16" / 2-5/8") 45°: 47.5 / 45.5 mm (1-7/8" / 1-13/16") 56°: 35.5 / 34 mm (1-3/8" / 1-5/16")
No Load Speed (RPM)	6,000
Dimensions (L x W x H)	w/ BL4025: 316x200x290 mm (12-1/2"x7-7/8"x11-3/8") w/ BL4040: 331x200x290 mm (13"x7-7/8"x11-3/8")
Net weight	4.1 - 4.4 kg (9.0 - 9.7 lbs.)

40Vmax



XGT BL AWS ADT XPT

TCT Saw Blade, Dust Nozzle, Hex Wrench, Battery, Charger, Z: Battery and Charger are sold separately

**HS004GM201 (RM2) / GZ**  
190mm / 185mm (7-1/2" / 7-1/4") Cordless Circular Saw

BL motor delivers 6,000 RPM for fast cutting

Li-ion Ah 8.0 5.0 4.0 2.5 2.0



Blade Diameter	190 / 185 mm (7-1/2" / 7-1/4")
Max Cutting Capacity	90°: 62.5 / 60 mm (2-7/16" / 2-3/8") 45°: 44.5 / 43 mm (1-3/4" / 1-11/16") 48°: 42 / 41 mm (1-5/8" / 1-5/8")
No Load Speed (RPM)	6,000
Dimensions (L x W x H)	w/ BL4025: 322x210x290 mm (12-5/8"x8-1/4"x11-3/8") w/ BL4040: 337x210x290 mm (13-1/4"x8-1/4"x11-3/8")
Net weight	4.4 - 4.7 kg (9.7 - 10.4 lbs.)

40Vmax



XGT BL AWS ADT XPT

TCT Saw Blade, Dust Nozzle, Hex Wrench, Guide Rule, Battery, Charger, Z: Battery and Charger are sold separately

**HS012GZ 165mm (6-1/2") Cordless Circular Saw**

40Vmax XGT BL AWS Cordless Circular Saw, Electric Brake, Soft Start, Twin LED Light

Li-ion Ah 8.0 5.0 4.0 2.5 2.0



Wheel Diameter	165 mm (6-1/2")
Hole Diameter	20 mm (13/16")
Max Cutting Capacity	0°: 57 mm (2-1/4") 45°: 41 mm (1-5/8")
No Load Speed (RPM)	5,200
Dimensions (L x W x H)	w/ BL4020 / BL4025: 352 x 157 x 246 mm (13-7/8 x 6-3/16 x 9-11/16") w/ BL4040: 359 x 157 x 246 mm (14-9/64 x 6-3/16 x 9-11/16") w/ BL4080F: 406 x 157 x 246 mm (15-63/64 x 6-3/16 x 9-11/16")
Net weight	3.2 - 4.4 kg (7.1 - 9.7 lbs.)

40Vmax



XGT BL AWS ADT XPT

TCT saw blade, Guide rule, Dust nozzle, Hex wrench, Battery, Charger, Z: Battery and Charger are sold separately



**DHS900Z 235mm (9-1/4") Cordless Circular Saw**

Magnesium Circular Saw, Electric Brake, Soft Start, Twin LED Light

Li-ion Ah 6.0 5.0 3.0 1.5



Blade Diameter	235 mm (9-1/4")
Max Cutting Capacity	90°: 85 mm (3-3/8") 45°: 61 mm (2-3/8") 60°: 44 mm (1-3/4")
No Load Speed (RPM)	6,000
Dimensions (L x W x H)	413x196x316 mm (16-1/4"x7-3/4"x12-1/2")
Net weight	5.3 - 6.0 kg (11.7 - 13.2 lbs.)

18V x2



XGT BL AWS ADT XPT

TCT Saw Blade, Sub Base, Hex Wrench, Battery, Charger, Z: Battery and Charger are sold separately

**DHS710Z 190mm / 185mm (7-1/2" / 7-1/4") Cordless Circular Saw**

Makita-built motor delivers 4,800 RPM for fast cutting and ripping

442 mm

Li-ion Ah 6.0 5.0 3.0 1.5



Blade Diameter	190 / 185 mm (7-1/2" / 7-1/4")
Max Cutting Capacity	90°: 68.5 / 66 mm (2-11/16" / 2-5/8") 45°: 49 / 47.5 mm (1-15/16" / 1-7/8") 50°: 44 / 42.5 mm (1-3/4" / 1-11/16")
No Load Speed (RPM)	4,800
Dimensions (L x W x H)	356 x 217 x 298 mm (14 x 8-1/2 x 11-3/4")
Net weight	3.9 - 4.6 kg (8.6 - 10.1 lbs.)

18V x2



XGT

TCT Saw Blade, Rip Fence (Guide Rule), Hex Wrench, Battery, Charger, Z: Battery and Charger are sold separately

**DHS661RGJ / Z 165mm (6-1/2") Cordless Circular Saw**

Compact and Lightweight

Li-ion Ah 6.0 5.0 3.0 1.5



Blade Diameter	165 mm (6-1/2")
Hole Diameter	15.88 / 20 mm (5/8" / 13/16")
Max Cutting Capacity	90°: 57 mm (2-1/4"), 45°: 41 mm (1-5/8") 50°: 37 mm (1-7/16")
No Load Speed (RPM)	5,000
Sound Power Level	104 dB(A)
Dimensions (L x W x H)	270x186x250 mm (10-5/8"x7-3/8"x9-7/8")
Net weight	2.9 - 3.2 kg

18V



XGT BL AWS ADT XPT

TCT Saw Blade, Hex Wrench, Rip Fence (Guide Rule), Dust Nozzle, Battery, Fast Charger, Z: Battery and Charger are sold separately

**DHS660Z 165mm (6-1/2") Cordless Circular Saw**

Compact and Lightweight

Li-ion Ah 6.0 5.0 3.0 1.5



Blade Diameter	165 mm (6-1/2")
Hole Diameter	15.88 / 20 mm (5/8" / 13/16")
Max Cutting Capacity	90°: 57 mm (2-1/4"), 45°: 41 mm (1-5/8") 50°: 37 mm (1-7/16")
No Load Speed (RPM)	5,000
Sound Power Level	104 dB(A)
Dimensions (L x W x H)	270x186x250 mm (10-5/8"x7-3/8"x9-7/8")
Net weight	2.9 - 3.2 kg (6.3 - 7.0 lbs.)

18V



XGT BL AWS ADT XPT

TCT Saw Blade, Hex Wrench, Rip Fence (Guide Rule), Dust Nozzle, Battery, Fast Charger, Z: Battery and Charger are sold separately

## DSS610RTE / Z 165mm (6-1/2") Cordless Circular Saw

Lightweight and compact design

441

Li-ion Ah 6.0 5.0 3.0 1.5



Blade Diameter	165 mm (6-1/2")
Max Cutting Capacity	90°: 0-57 mm (2-1/4") 45°: 0-40 mm (1-9/16") 50°: 0-36 mm (1-7/16")
No Load Speed (RPM)	3,700
Dimensions (L x W x H)	347x202x228 mm (13-5/8"x8"x9")
Net weight	3.0 - 3.4 kg (6.7 - 7.5 lbs)

DSS610RTE

DSS610Z

18V



Fast Charger, Battery Cartridge, Carbide-tipped Saw Blade, Guide Rule, Hex Wrench, Z: Battery and Charger are sold separately

## DSS501RTE / Z 136mm (5-3/8") Cordless Circular Saw

Well balanced tool design for high maneuverability

430

Li-ion Ah 6.0 5.0 3.0 1.5



Blade Diameter	136 mm (5-3/8")
Max Cutting Capacity	90°: 51 mm (2") 45°: 35 mm (1-3/8")
No Load Speed (RPM)	3,600
Dimensions (L x W x H)	364x183x201 mm (14-3/8"x7-1/4"x7-7/8")
Net weight	2.4 - 2.7 kg (5.3 - 6.0 lbs)

18V



Fast Charger, Battery Cartridge, Carbide-tipped Saw Blade, Guide Rule, Hex Wrench, Z: Battery and Charger are sold separately

## HS301DWAE / DZ 85mm (3-3/8") Cordless Circular Saw

High power, high cutting efficiency

Li-ion Ah 5.0 4.0 2.0 1.5



Blade Diameter	85 mm (3-3/8")
Max Cutting Capacity	90°: 25.5 mm (1") 45°: 16.5 mm (5/8")
No Load Speed (RPM)	1,500
Max Output	160W
Dimensions (L x W x H)	313x170x155mm (12-3/8"x6-11/16"x6-1/8")
Net Weight	1.6 - 1.7kg (3.5 - 3.8lbs)

HS301DWAE

HS301DZ

12Vmax



TCT saw blade, Hex wrench, Battery, Charger, DZ: Battery and Charger are sold separately

## HS300DW / DZ 85mm (3-3/8") Cordless Circular Saw

Lightweight and Compact design

Li-ion Ah 1.3



Blade Diameter	85 mm (3-3/8")
Max Cutting Capacity	90°: 25.5 mm (1") 45°: 16.5 mm (5/8")
No Load Speed (RPM)	1,400
Dimensions (L x W x H)	300x170x154mm (11-3/4"x6-11/16"x6-1/16")
Net Weight	1.5 kg (3.3 lbs)

10.8V



Charger, Battery Cartridge, T.C.T Saw Blade, Hex Wrench, DZ: Battery and Charger are sold separately

## HS6600 165mm (6-1/2") Circular Saw

Powerful 1,050 W motor delivers 5,200 RPM for performance

303



Continuous rating Input	1,050W
Blade Diameter	165 mm (6-1/2")
Hole Diameter	15.88, 20, 25.4, 30 mm (5/8, 13/16, 1, 1-3/16")
Max Cutting Capacity	0°: 54.5 mm (2-1/8") 45°: 37.5 mm (1-1/2")
No Load Speed (RPM)	5,200
Dimensions (L x W x H)	296 x 230 x 243 mm (11-5/8" x 9" x 9-9/16")
Net weight	3.5 kg (7.6 lbs.)
Power supply cord	2.5 m (8.2 ft)



Rip Fence (Guide Rule), TCT Saw Blade, Hex Wrench

## 5806B 185mm (7-1/4") Circular Saw

Sawdust and chips hardly ever come near operator

303



Continuous Rating Input	1,050W
Blade Diameter	185 mm (7-1/4")
Max Cutting Capacity	90°: 66 mm (2-5/8") 45°: 44 mm (1-11/16")
No Load Speed (RPM)	5,200
Overall Length	282 mm (11-1/8")
Net Weight	3.5kg (7.6lbs)
Power Supply Cord	2.5m (8.2ft)



Carbide-Tipped Saw Blade, Hex Wrench, Rip Fence (Guide Rule)

## HS7600 185mm (7-1/4") Circular Saw

New aesthetic design with Soft grip

303



Continuous Rating Input	1,200W
Blade Diameter	185 mm (7-1/4")
Max Cutting Capacity	90°: 64 mm (2-1/2") 45°: 42 mm (1-5/8")
No Load Speed (RPM)	5,200
Vibration Level	Cutting Wood: 2.5 m/s <sup>2</sup> or less
Sound Power Level	98 dB(A)
Dimensions (L x W x H)	309x234x255mm (12-1/8"x9-1/4"x10")
Net Weight	3.8 kg (8.3 lbs)
Power Supply Cord	2.5 m (8.2 ft)



TCT Saw Blade, Hex wrench, Rip fence (guide rule)

## HS7010 185mm / 190mm (7-1/2" / 7-1/4") Circular Saw

185 mm (7-1/4") / 190 mm (7-1/2") 1,600 W Circular Saw

303



Continuous Rating Input	1,600W
Blade Diameter	185 / 190 mm (7-1/4" / 7-1/2")
Max Cutting Capacity	90°: 65 / 67 mm (2-9/16" / 2-5/8") 45°: 44 / 45 mm (1-3/4" / 1-3/4")
No Load Speed (RPM)	5,500
Dimensions (L x W x H)	300x240x261 mm (11-3/4"x9-1/2"x10-1/4")
Net Weight	4.0 kg (8.9 lbs)
Power Supply Cord	2.5 m (8.2 ft)



TCT Saw Blade, Rip Fence (Guide Rule), Hex Wrench



**5008MG 210mm (8-1/4") Circular Saw**

Maximum cutting depth of 75.5mm (3")



Continuous Rating Input	1,800W
Blade Diameter	210 mm (8-1/4")
Max Cutting Capacity	90°: 75.5 mm (3") 45°: 57 mm (2-1/4") 50°: 51.5 mm (2")
No Load Speed (RPM)	5,200
Dimensions (L x W x H)	332x243x277mm (13-1/8"x9-9/16"x10-7/8")
Net Weight	4.8kg (10.6lbs)
Power Supply Cord	2.5m (8.2ft)



TCT Saw Blade, Hex Wrench, Rip Fence (Guide Rule)

**N5900B 235mm (9-1/4") Circular Saw**

Bevel cuts up to 50 degrees



Continuous Rating Input	2,000W
Blade Diameter	235 mm (9-1/4")
Max Cutting Capacity	90°: 85 mm (3-3/8") 45°: 60 mm (2-3/8") 50°: 53 mm (2-1/16")
No Load Speed (RPM)	4,100
Overall Length	380 mm (15")
Net Weight	6.8kg (14.8lbs)
Power Supply Cord	2.5m (8.2ft)



T. C. T Saw Blade, Grip, Wrench, Rip Fence

**HS0600 270mm / 260mm (10-5/8" / 10-1/4") Circular Saw**

270 mm (10-5/8") 2,000 W Circular Saw



Continuous Rating Input	2,000W
Blade Diameter	260 - 270 mm (10-1/4" - 10-5/8")
Max Cutting Capacity	90°: 97 mm (3-13/16") 45°: 68 mm (2-11/16")
No Load Speed (RPM)	4,300
Sound Power Level	105 dB(A)
Dimensions (L x W x H)	418x273x324 mm (16-1/2"x10-3/4"x12-3/4")
Net Weight	6.9 kg (15.2 lbs)
Power Supply Cord	2.5 m (8.2 ft)



TCT Saw Blade, Hex Wrench, Rip Fence (Guide Rule)

**5103N 335mm (13-1/8") Circular Saw**

Huge cutting capacity with efficient control



Continuous Rating Input	1,750W
Blade Diameter	335 mm (13-1/8")
Max Cutting Capacity	90°: 128 mm (5") 45°: 91 mm (3-5/8")
No Load Speed (RPM)	2,900
Overall Length	505 mm (19-7/8")
Net Weight	8.9kg (19.6lbs)
Power Supply Cord	5.0m (16.4ft)



Combination Saw Blade, Wrench, Hex Wrench, Rip Fence (Guide Rule)

**JIG SAW**

**PRODUCTS**



**JV002GM201(RM2J) / GZ Cordless Jig Saw**

**New**

Top Handle Jig Saw, 3 Orbital Settings plus Straight Cutting, Twin LED Lights

Li-ion Ah 8.0 | 5.0 | 4.0 | 2.5 | 2.0



Capacity	Wood: 135 mm (5-5/16") Mild Steel: 10 mm (3/8") Aluminum: 20 mm (25/32")
Stroke length	26 mm (1")
Strokes per minute (SPM)	0 - 3,500
Bevel range	0 - 45°
Vibration level	4.2m/s <sup>2</sup>
Work mode:	cutting sheet metal
Dimensions (L x W x H)	w/ BL4025: 272 x 84 x 208 mm (10-3/4 x 3-5/16 x 8-3/16")
Net weight	2.7 - 3.0 kg (6.0 - 6.6 lbs.)

40Vmax



Jig saw blade, Cover plate, Kert board, Hex wrench, Battery, Charger, Z: Battery and Charger are sold separately

**Cutting speed 20% up**  
Compared to predecessor 18V model

**BL MOTOR**

## DJV182RTE / Z Cordless Jig Saw

Top handle type cordless jig saw powered by Li-ion batteries

Li-ion Ah 6.0 | 5.0 | 3.0 | 1.5



Capacity	Wood: 135 mm (5-5/16") Steel: 10 mm (3/8")
Length of Stroke	26 mm (1")
Strokes Per Minute (SPM)	800 - 3,500
Dimensions (L x W x H)	266x77x208 mm (10-1/2"x3"x8-3/16")
Net weight	2.4 - 2.7 kg (5.2 - 5.9 lbs)

Cutting capacity in wood: when cutting with optional blade No.B-16L

DJV182RTE  
2DJV182Z  
4

18V



Fast Charger, Battery Cartridge, Jig Saw Blade Assortment, Cover Plate, Anti-splintering Device, Hex Wrench, Z: Battery and Charger are sold separately



## DJV184RTJ / Z Cordless Jig Saw

3 Orbital Settings Plus Straight Cutting, LED Light

Li-ion Ah 6.0 | 5.0 | 3.0 | 1.5



Capacity	Wood: 135 mm (5-5/16") Steel: 10 mm (3/8") Aluminum: 20 mm (25/32")
Length of Stroke	23 mm (7/8")
Strokes Per Minute (SPM)	0 - 3,000
Dimensions (L x W x H)	259 x 78 x 205 mm (10-1/4 x 3-1/16 x 8-1/8")
Net weight	2.1 - 2.5 kg (4.6 - 5.5 lbs.)

18V



Jig Saw Blade, Hex Wrench, Cover Plate, Battery, Charger, Z: Battery and Charger are sold separately

## JV103DSAJ / DZ Cordless Jig Saw

Disabling soft no-load rotation function in operator's preference

Li-ion Ah 5.0 | 4.0 | 2.0 | 1.5

JV103DSAJ  
1  
JV103DZ  
5

Max Cutting Capacity at 90°	Wood: 90mm (3-1/2") Aluminum: 20mm (13/16") Mild Steel: 10mm (3/8")
Length of Stroke	23 mm (7/8")
Strokes Per Minute (SPM)	800 - 3,000
Sound Power Level	96 dB(A)
Dimensions (L x W x H)	237x76x206 mm (9-3/8"x3"x8-1/8")
Net Weight	1.9 - 2.0 kg (4.1 - 4.4 lbs)

12Vmax



Jig Saw Blade, Hex Wrench, Battery, Charger, DZ: Battery and Charger are sold separately



## JV101DSAE / DZ Cordless Jig Saw

12Vmax CXT Li-Ion Cordless Top Handle Jig Saw

Li-ion Ah 5.0 | 4.0 | 2.0 | 1.5

JV101DSAE  
3  
JV101DZ  
5

Max Cutting Capacity at 90°	Wood: 65mm (2-9/16") Aluminum: 4mm (5/32") Mild Steel: 2mm (1/16")
Length of Stroke	18 mm (11/16")
Strokes Per Minute (SPM)	0-2,900
Sound Power Level	91 dB(A)
Dimensions (L x W x H)	232x76x196mm (9-1/8"x3"x7-3/4")
Net Weight	1.8 - 1.9kg (3.9 - 4.3lbs)

12Vmax



Jig Saw Blade, Hex Wrench, Battery, Charger, DZ: Battery and Charger are sold separately

## 4327M Jig Saw

High power and Lightweight

64



Continuous Rating Input	450W
Capacity	Wood: 40 mm (1-9/16") Steel: 6 mm (1/4")
Length of Stroke	18 mm (11/16")
Strokes Per Minute (SPM)	500 - 3,100
Dimensions (L x W x H)	224x77x197mm (8-7/8"x3"x7-3/4")
Net Weight	1.8 kg (4.0 lbs.)
Power Supply Cord	2.0m (6.6ft)



Jig Saw Blade, Hex Wrench

## JV0600K Jig Saw

Powerful and Maneuverable

64



Continuous Rating Input	650W
Capacity	Wood: 90 mm (3-1/2") Steel: 10 mm (3/8")
Length of Stroke	23 mm (7/8")
Strokes Per Minute (SPM)	500 - 3,100
Dimensions (L x W x H)	236x77x199mm (9-1/4"x3"x7-7/8")
Net Weight	2.4kg (5.2lbs)
Power Supply Cord	2.5m (8.2ft)



Jig Saw Blade, Hex Wrench



# PLANING & ROUTERING

## PRODUCTS



### KP001GZ 82mm (3-1/4") Cordless Planer

40Vmax XGT BL AWS ADT Cordless 82 mm (3-1/4") Planer

Li-ion Ah 8.0 | 5.0 | 4.0 | 2.5 | 2.0



Planing Width	82 mm (3-1/4")
Planing Depth	4 mm (5/32")
Shiplapping	25 mm (1")
No Load Speed (RPM)	15,000
Dimensions (L x W x H)	379 x 156 x 166 mm (14-7/8 x 6-1/8 x 6-1/2")
Net weight	3.8 - 4.4 kg (8.3 - 9.6 lbs.)

40Vmax



Planer Blade, Blade Gauge, Guide Rule, Depth Guide, Socket Wrench, Sharpening Holder Assembly (for resharpenable blade), Battery, Charger, Z: Battery and Charger are sold separately

Photo: KP001G



connects to compatible vacuum cleaners via Bluetooth.



### DKP181Z 82mm (3-1/4") Cordless Planer

High power BL motor delivers powerful cutting

Li-ion Ah 6.0 | 5.0 | 3.0 | 1.5



Planing Width	82 mm (3-1/4")
Planing Depth	3 mm (1/8")
Max Shiplapping	25mm (1")
No Load Speed (RPM)	12,000
Dimensions (L x W x H)	366x156x166 mm (14-3/8"x6-1/8"x6-1/2")
Net weight	3.3 - 3.6 kg (7.3 - 7.9 lbs.)

18V



Planer Blade, Blade Gauge, Guide Rule, Socket Wrench, Dust Nozzle, Z: Battery and Charger are sold separately

### KP0800X 82mm (3-1/4") Power Planer

Angle and shape of handle are easy to grip, push and carry

411 W



Continuous Rating Input	620W
Planing Width	82 mm (3-1/4")
Planing Depth	2.5 mm (3/32")
No Load Speed (RPM)	17,000
Dimensions (L x W x H)	285x158x158mm (11-1/4"x6-1/4"x6-1/4")
Net Weight	2.8 kg (6.2 lbs)
Power Supply Cord	2.5 m (8.2 ft)



Blade Gauge Assembly, Guide Rule, Planer Blade, Socket Wrench, Sharpening Holder, Shiplapping: 9 mm (11/32")

### 1911B 110mm (4-3/8") Power Planer

Planes up to 110mm (4-3/8") wide and 2mm (1/16") deep in a single pass

106 W



Continuous Rating Input	840W
Planing Width	110 mm (4-3/8")
Planing Depth	2 mm (1/16")
No Load Speed (RPM)	16,000
Overall Length	355 mm (14")
Net Weight	4.3kg (9.5lbs)
Power Supply Cord	5.0m (16.4ft)



Sharpening Holder Assembly, Blade Gauge Assembly, Socket Wrench, Planer Blade

### 1805N 155mm (6-1/8") Power Planer

Rugged aluminum housing and easy depth settings

153 W



Continuous Rating Input	1,140W
Planing Width	155 mm (6-1/8")
Planing Depth	2 mm (1/16")
No Load Speed (RPM)	15,000
Overall Length	445 mm (17-1/2")
Net Weight	7.9kg (17.3lbs)
Power Supply Cord	5.0m (16.4ft)



Sharpening Holder Assembly, Blade Gauge Assembly, Socket Wrench, Planer Blade

**2012NB 304mm (12") Power Planer**

Compact and lightweight for easier transport

153



Continuous Rating Input	1,650W
Cutting Width	304 mm (12")
Cutting Depth	Cutting width 0-150mm: 3mm (1/8") Cutting width 150-240mm: 1.5mm (1/16")
Feed Rate/min.	8.5m (27.9ft)
Table Size (W x L)	304 x 771 mm (12" x 30-3/8")
No Load Speed (RPM)	8,500
Dimensions (L x W x H)	483x771x401mm (19"x30-3/8"x15-13/16")
Net Weight	28.1kg (61.9lbs)
Power Supply Cord	2.5m (8.2ft)



Socket Wrench, Hex Wrench, Magnetic Holders x2, Planer Blade 306

**DPJ180Z Cordless Plate Joiner**

New top handle with flat shape on side surface for excellent tool control

430



Li-ion Ah 6.0 | 5.0 | 3.0 | 1.5

Blade Diameter	100 mm (4")
Max cutting depth	20 mm (3/4")
No Load Speed (RPM)	6,500
Dimensions (L x W x H)	351x139x149 mm (13-3/4"x5-1/2"x5-7/8")
Net weight	2.8 - 3.1 kg (6.2 - 6.8 lbs)

18V



Cutter Blade, Angle Guide, Lock Nut Wrench, Set Plate, Dust Bag, Z: Battery and Charger are sold separately

**PJ7000 Plate Joiner**

Cast aluminum pivot fence with three positive stops at 0°, 45° and 90°

459



Continuous Rating Input	701W
Blade Diameter	100 mm (4")
No Load Speed (RPM)	11,000
Dimensions (L x W x H)	302x139x145mm (11-7/8"x5-1/2"x5-3/4")
Net Weight	2.8kg (6.2lbs)
Power Supply Cord	2.5m (8.2ft)



Cutter Blade, Angle Guide, Dust Bag, Set Plate, Lock Nut Wrench

**DCO181Z 6.35mm (1/4") Cordless Cut-Out Tool**

High power delivered by BL motor

Li-ion Ah 6.0 | 5.0 | 3.0 | 1.5



Collet Capacity	3 mm, 6 mm or 1/8", 1/4"
No load speed (rpm)	32,000
Max Output	600W
Circumference of Grip Portion	210 mm (8-1/4")
Dimensions (L x W x H)	w/ BL1815N: 293x79x117 mm (11-1/2"x3-1/8"x4-5/8") w/ BL1830B / BL1850B / BL1860B: 311x79x117 mm (12-1/4"x3-1/8"x4-5/8")
Net weight	1.4 - 1.7 kg (3.1 - 3.7 lbs.)

18V



Drywall Guide Bit, Collet Cone, Dust Collection Cover, Wrench, Battery, Charger, Z: Battery and Charger are sold separately

**RT001GM202(RM2J) / GZ04  
6mm (1/4"), 8mm (3/8") Cordless Trimmer**

Compatible with the bases used for DRT50

Li-ion Ah 5.0 | 4.0 | 2.5 | 2.0



Collet Capacity	6, 8 mm or 1/4 - 3/8"
No Load Speed (RPM)	10,000 - 31,000
Plunge Capacity	w/ Trimmer Base: 0 - 40 mm (0 - 1-9/16") w/ Plunge Base: 0 - 35 mm (0 - 1-3/8")
Dimensions (L x W x H)	w/ BL4020 / BL4025: 126 x 89 x 245 mm (5 x 3-1/2 x 9-5/8") w/ BL4040: 141 x 89 x 261 mm (5-9/16 x 3-1/2 x 9-7/8")
Net weight	2.2 - 2.5 kg (4.9 - 5.5 lbs.)

40Vmax



Collet Cone, Trimmer Base Assembly, Straight Guide Assembly, Dust Nozzle, Battery, Charger, Z: Battery and Charger are sold separately

**DRT50Z 6mm (1/4"), 8mm (3/8") Cordless Trimmer**

Cordless for easy maneuverability and 4 different bases for added versatility

Li-ion Ah 6.0 | 5.0 | 3.0 | 1.5



Collet Capacity	6, 8 mm or 1/4, 3/8"
No Load Speed (RPM)	10,000 - 30,000
Plunge Capacity	w/ Trimmer Base: 0 - 40 mm (0 - 1-9/16") w/ Plunge Base: 0 - 35 mm (0 - 1-3/8")
Dimensions (L x W x H)	w/ BL1815N / BL1820B: 134 x 89 x 208 (5-1/4 x 3-1/2 x 8-1/8) w/ BL1830B / BL1850B / BL1860B: 134 x 89 x 226 mm (5-1/4 x 3-1/2 x 8-7/8")
Net weight	1.8 - 2.1 kg (3.9 - 4.6 lbs.)

18V



Collet Cone, Trimmer Base Assembly, Straight Guide Assembly, Templet Guide, Wrench x2, Trimmer Guide, Battery, Fast Charger, Z: Battery and Charger are sold separately

BL motor delivers the power and performance for corded demands

**Easy-to-Customize**



Photo: RT001G



**DRT52Z** 6mm (1/4") Cordless Trimmer

New

18V LXT BL Brushless Cordless 6 mm (1/4") Trimmer

Li-ion Ah 6.0 | 5.0 | 3.0 | 1.5



Collet Capacity	6 mm (1/4")
No Load Speed (RPM)	30,000 min <sup>-1</sup>
Max output	580 W
Dimensions (L x W x H)	w/ BL1830B / BL1850B / BL1860B: 134 x 90 x 220 mm (5-1/4 x 3-1/2 x 8-5/8")
Net weight	1.4 - 1.7 kg (3.1 - 3.7 lbs.)

18V **LXT BL XPT**

Wrench, Templet guide, Chip deflector, Straight bit, Trimmer guide assembly, Straight guide assembly, Battery, Charger, Z. Battery and Charger are sold separately

**RT0700C / CX2** 6mm (1/4"), 8mm (3/8") Trimmer

Aluminum housing and base for higher durability and accuracy

411



Continuous Rating Input	710W
Collet Capacity	6mm, 8mm or 1/4", 3/8"
No Load Speed (RPM)	10,000-30,000
Sound Power Level	93 dB(A)
Dimensions (L x W x H)	89x89x200mm (3-1/2"x3-1/2"x7-7/8")
Net Weight	1.8 - 2.7kg (3.9 - 6.0lbs)
Power Supply Cord	2.5m (8.2ft)

2

Trimmer Base Assembly, Straight Guide, Collect Cone x2, Wrench x2, Template Guide x1

**N3701** 6mm (1/4") Trimmer

Transparent acrylic base for clear view of trimming area and sight line

51



Continuous Rating Input	440W
Collet Capacity	6mm or 1/4"
No Load Speed (RPM)	30,000
Overall Height	181 mm (7-1/8")
Net Weight	1.6kg (3.4lbs)
Power Supply Cord	2.5m (8.2ft)

4

Trimmer Guide Assembly, Straight Guide Assembly, Template Guide, Straight Bit (Carbide-Tipped), Wrench (2pcs.)

**3711** 6mm (1/4") Trimmer

6 mm (1/4") 530 W Fixed Base Trimmer



Continuous rating Input	530W
Collet Capacity	6 mm or 1/4"
No Load Speed (RPM)	32,000
Plunge Capacity	0 - 42 mm (0 - 1-5/8")
Dimensions (L x W x H)	82 x 90 x 211 mm (3-1/4 x 3-1/2 x 8-5/16")
Net weight	1.5 kg (3.3 lbs.)
Power supply cord	2.5 m (8.2 ft)

1

Collet Cone, Trimmer Guide, Straight Guide Assembly, Templet Guide, Straight Bit, Chip Deflector, Wrench



**RP0900** 8mm (3/8") Router (Plunge type)

High durability and good design router

106



Continuous Rating Input	900W
Capacity	Collet: 6mm, 8mm or 1/4", 3/8"
No Load Speed (RPM)	27,000
Sound Power Level	100 dB(A)
Dimensions (L x W x H)	110 x 256 x 217mm (10-3/32"x4-5/16"x8-17/32")
Net Weight	2.7kg (6.0lbs)
Power Supply Cord	2.5m (8.2ft)

2

Straight Guide, Collet Cone, Wrenches

**3601B** 12mm (1/2") Router

Fine power-to-weight ratio in this well-balanced router

153



Continuous Rating Input	930W
Collet Capacity	12mm or 1/2"
No Load Speed (RPM)	23,000
Overall Height	190 mm (7-1/2")
Net Weight	3.6kg (7.9lbs)
Power Supply Cord	5.0m (16.4ft)

3

Trimmer Guide Assembly, Straight Guide Assembly, Template Guide, Collet Sleeve (6mm or 1/4"), Collet Sleeve (8mm or 3/8"), Wrench (2pcs.), Straight Bit (Carbide-Tipped)

**4403** 6mm (1/4") Sash Router

Mills and drills aluminum for sashes

411



Continuous Rating Input	530W
Collet Capacity	6 mm or 1/4"
Max Width of Work	123 mm (4-7/8")
Max Width of Work (45°)	77 mm (3")
Max Height of Work	185 mm (7-1/4")
Transverse Travel of Table (Bed)	113 mm (4-1/2")
Longitudinal Travel of Table (Bed)	73 mm (2-7/8")
No Load Speed (RPM)	30,000
Dimensions (L x W x H)	327x350x355 mm (12-7/8"x13-13/16"x14")
Net Weight	16 kg (35.3 lbs)
Power Supply Cord	2.5 m (8.2 ft)

1

Sash Router Bit (Drill Point), Angle Gauge, Wrench x2, Oil Supply, Collet Cone (6mm or 1/4")

# SANDING & POLISHER

## PRODUCTS



### DSL801Z 225mm (8-7/8") Cordless Drywall Sander

#### Variable Speed Drywall Sander

Li-ion Ah 6.0 5.0 3.0 1.5



Pad diameter	210 mm (8-1/4")
Abrasive Disc Size	225 mm (8-7/8")
No Load Speed (RPM)	1,000 - 1,800
Dimensions (L x W x H)	1,120 - 1,540 x 278 x 273 mm (44 - 60-1/2 x 11 x 10-3/4")
Net weight	4.6 - 5.8 kg (10.1 - 12.8 lbs.)

18V



LXT BL AWS XPT

1

Abrasive Disc, Hex Wrench, Tool Bag, Battery, Charger, Z: Battery and Charger are sold separately

### DSL800Z 225mm (8-7/8") Cordless Drywall Sander

#### Constant speed control for smooth finish

Li-ion Ah 6.0 5.0 3.0 1.5



Pad diameter	210 mm (8-1/4")
Abrasive Disc Size	225 mm (8-7/8")
No Load Speed (RPM)	1,000 - 1,800
Max Output	260 W
Sound Pressure Level	75 dB(A)
Dimensions (L x W x H)	1,100 - 1,520 x 259 x 273 mm (43-1/4" - 59-3/4" x 10-1/4" x 10-3/4")
Net weight	4.5 - 5.7 kg (10.0 - 12.6 lbs.)

18V



LXT BL AWS XPT

1

Abrasive Disc, Hex Wrench, Tool Bag, Battery, Charger, Z: Battery and Charger are sold separately

### DPO600RTE / Z 150mm (6") Cordless Random Orbit Polisher

#### Random Orbit Polisher

Li-ion Ah 6.0 5.0 3.0 1.5



DPO600RTE / Z

Pad Size	150 mm (6")
Orbits Per Minute (OPM)	0 - 6,800
Strokes Per Minute (SPM)	0 - 13,600
No Load Speed (RPM)	0 - 780
Sound Pressure Level	83 dB(A)
Sound Power Level	94 dB(A)
Orbit Diameter	5.5 mm (7/32")
Dimensions (L x W x H)	530 x 148 x 126 mm (20-7/8" x 5-7/8" x 5")
Net Weight	3.1 - 3.6 kg (6.9 - 7.9 lbs.)

18V



LXT BL XPT

1

Side Grip, Hex Wrench, Z: Battery and Charger are sold separately

### PO6000C 150mm (6") Random Orbit Polisher

#### Random Orbit Polisher

318 W



Continuous Rating Input	900W
Pad Size	150 mm (6")
Orbits Per Minute (OPM)	0 - 6,800
Strokes Per Minute (SPM)	0 - 13,600
No Load Speed (RPM)	0 - 780
Sound Pressure Level	94 dB(A)
Orbit Diameter	5.5 mm (7/32")
Dimensions (L x W x H)	451 x 148 x 126 mm (17-3/4" x 5-7/8" x 5")
Net Weight	2.8 - 3.0 kg (6.2 - 6.5 lbs.)
Power Supply Cord	4.0 m (13.1 ft)

18V



2

Hex Wrench

### BO6050J Random Orbit Sander

#### Random orbit sander with soft start

326 W



Continuous Rating Input	750W
Pad Diameter	150mm (6")
Abrasive Disc Size	150 mm (6")
Orbits Per Minute (OPM)	1,600 - 6,800
Sanding Strokes Per Minute (SPM)	3,200 - 13,600
Pad Speed in Roto-orbit Mode (rpm)	140 - 600
Orbit Diameter	5.5 mm (7/32")
Dimensions (L x W x H)	330 x 155 x 145 mm (13" x 6-1/8" x 5-3/4")
Net Weight	2.6 kg (5.7 lbs)
Power Supply Cord	2.5m (8.2ft)



1

Abrasive disc, Dust nozzle, Side grip, Pad protector

### DBO180Z Cordless Random Orbit Sander

#### Excellent performance with high orbital speed

Li-ion Ah 6.0 5.0 3.0 1.5



Pad diameter	123 mm (4-7/8")
Abrasive Disc Size	125 mm (5")
Orbits Per Minute (OPM)	7,000/9,500/11,000
Dimensions (L x W x H)	175 x 123 x 153 mm (6-7/8" x 4-7/8" x 6")
Net weight	1.4 - 1.7 kg (3.0 - 3.7 lbs)

18V



3

Dust Bag, Z: Battery and Charger are sold separately



**BO5031** Random Orbit Sander

Powerful motor and high durability

419



Continuous Rating Input	300W
Pad Diameter	123mm (4-7/8")
Abrasive Disc Size	125 mm (5")
Orbits Per Minute (OPM)	4,000-12,000
Dimensions (L x W x H)	153x123x153mm (6"x4-7/8"x6")
Net Weight	1.3kg (3.0lbs)
Power Supply Cord	2.0m (6.6ft)



Abrasive Disc, Dust Bag Or Dust Box

**PV001GM101(RMX) / GZ** Cordless Polisher

40Vmax XGT BL Brushless Cordless 180 mm (7") Polisher

Li-ion Ah 8.0 | 5.0 | 4.0 | 2.5 | 2.0



Capacity	Pad: 180mm
No Load Speed (RPM)	0 - 2,200
Dimensions (L x W x H)	w/ BL4050F: 547 x 198 x 196 mm (21-1/2 x 7-3/4 x 7-3/4")
Net weight	3.1 - 3.8 kg (6.8 - 8.4 lbs.)



Loop Handle / Side Handle, Hex Wrench, Battery, Charger, Z: Battery and Charger are sold separately

**9237C** 180mm (7") Polisher

Elastomer bumper on gear housing

303



Continuous Rating Input	1,200W
Capacity	Wool Pad: 180mm (7") Wool Bonnet: 180mm (7")
No Load Speed (RPM)	0 - 3,200
Sound Power Level	94 dB(A)
Dimensions (L x W x H)	431x198x187mm (17"x7-3/4"x7-3/8")
Net Weight	3.2 - 3.4kg (7 - 7.5 lbs)
Power Supply Cord	2.5 m (8.2 ft)



Loop Handle Or Side Grip, Accessory Set

**PV7000C** 180mm (7") Polisher

Quick-Flip speed change for compounding and polishing

303



Continuous Rating Input	900W
Capacity	Pad: 180mm (7") Wool Bonnet: 180mm (7")
No Load Speed (RPM)	600 - 2,100
Overall Length	210 mm (8-1/4")
Net Weight	2.1 kg (4.6 lbs)
Power Supply Cord	2.5 m (8.2 ft)



Side Handle, Pad, Wrench

**DPV300RTJ / Z** Cordless Sander Polisher

18V LXT BL Cordless Sander Polisher

Li-ion Ah 6.0 | 5.0 | 3.0 | 1.5



Capacity	Polisher: 80 mm (3-1/8") Sander: 50 mm (2")
No Load Speed (RPM)	Polisher: 0 - 2,800 Sander: 0 - 9,500
Dimensions (L x W x H)	w/ BL1830B / BL1850B / BL1860B: 160 x 79 x 256 mm (6-5/16 x 3-1/8 x 10-1/8")
Net weight	1.3 - 1.6 kg (2.9 - 3.5 lbs.)



Side Grip, Pad, Adapter, Wool Pad, Sponge Pad, Z: Battery and Charger are sold separately

**Compact and highly efficient high maneuverability and long run time**

Photo: DPV300



Head length: 127mm



Toolless pad replacement



High/Low 2-speed selection with variable speed in each range

enables to adjust the speed setting to match user's needs.

- 1: Low (for polishing) 0 - 2,800 min<sup>-1</sup>
- 2: High (for sanding) 0 - 9,500 min<sup>-1</sup>

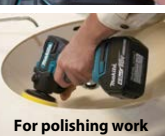

For polishing work

**PV301DSAE** Cordless Sander Polisher

12Vmax CXT BL Cordless Sander Polisher

Li-ion Ah 5.0 | 4.0 | 2.0 | 1.5



Capacity	Polisher: 80 mm (3-1/8") Sander: 50 mm (2")
No Load Speed (RPM)	Polisher: 0 - 2,800 Sander: 0 - 9,500
Dimensions (L x W x H)	w/ BL1016/BL1021B: 137 x 67 x 201 mm (5-3/8 x 2-5/8 x 7-7/8")
Net weight	1.1 - 1.2 kg (2.4 - 2.6 lbs.)



Side Grip, Pad, Adapter, Wool Pad, Sponge Pad

Long continuous operation time

Polishing performance comparison\*

\*Tested with normal load of 1.6kg, on a full battery charge

**PV301D**  
**18min**  
(with BL1041B)

**DPV300**  
**34min**  
(with BL1850B)

## PC5000C/B 125mm (5") Concrete Planer

Most Suitable for Planing Concrete

253



Lock Nut Wrench, Hex Wrench, Dust Bag Assembly, Brush Set

Continuous Rating Input	1,400W
Wheel Diameter	125 mm (5")
Hole Diameter	22.23mm (7/8")
No Load Speed (RPM)	10,000
Dimensions (L x W x H)	437x235x195mm (17-1/8"x9-1/4"x7-5/8")
Net Weight	4.0kg (8.9lbs)
Power Supply Cord	5.0m (16.4ft)

## PC5010C 125mm (5") Concrete Planer

Superior handling in horizontal and overhead applications

318



Lock Nut Wrench

Continuous rating input	1,400W
Wheel Diameter	125 mm (5")
Hole Diameter	22.23 mm (7/8")
No Load Speed (RPM)	4,000 - 9,000
Sound Power Level	96.0 dB(A)
Dimensions (L x W x H)	350x231x179 mm (13-3/4"x9-1/8"x7")
Net weight	2.5 - 3.6 kg (5.5 - 7.9 lbs.)
Power supply cord	4.0 m (13.1 ft)

## PK5001C 125 mm (5") Angle Sander

Powerful 1,400 W motor delivers more output and 2,000-6,800 RPM

318



Side Grip, Head Cover, Lock Nut Wrench

Continuous Rating Input	1,400W
Wheel Diameter	125 mm (5")
Capacity	Pad: 115mm (4-1/2")
No Load Speed (RPM)	2,000-6,800
Dimensions (L x W x H)	328x80x126mm (12-7/8"x3-1/8"x5")
Net Weight	2.5kg (5.5lbs)
Power Supply Cord	4.0m (13.1ft)

## GV6010 150mm (6") Disc Sander

Powerful 440W motor

64



Abrasive Disc, Plastic Pad, Side Grip, Hex Socket Head Bolt, Washer, Hex Wrench

Continuous Rating Input	440W
Abrasive Disc Size	150 mm (6")
Capacity	Pad: 120mm (4-3/4")
No Load Speed (RPM)	4,500
Dimensions (L x W x H)	200x74x181mm (7-7/8"x2-15/16"x7-1/8")
Net Weight	1.2kg (2.6lbs)
Power Supply Cord	2.5m (8.2ft)

## 9218SB 180mm (7") Disc Sander

Powerful 570W motor in well-balanced body for fast and steady sanding

100



Abrasive Disc, Rubber Pad, Lock Nut Wrench, Wrench, Side Grip

Continuous Rating Input	570W
Wire Cup Brush	110mm (4-3/8")
Abrasive Disc Size	180 mm (7")
No Load Speed (RPM)	4,500
Overall Length	225 mm (8-7/8")
Net Weight	2.3kg (5.1 lbs)
Power Supply Cord	2.5m (8.2ft)

## DBO380RTJ / Z Cordless Finishing Sander

High work efficiency similar to that of B03710

Li-ion Ah 6.0 5.0 3.0 1.5



Abrasive Paper, Dust Bag / Dust Box, Punch Plate, Z-Battery and Charger are sold separately

Pad Size	92 x 185 (3-5/8 x 7-1/4)
Abrasive Paper Size	93 x 228 (3-5/8 x 9)
Sanding Strokes (SPM)	8,000/ 16,000/ 24,000
Orbits Per Minute (OPM)	4,000/ 8,000/ 12,000
Dimensions (L x W x H)	w/ BL1830B / BL1850B / BL1860B: 332 x 92 x 169 mm (13-1/4 x 3-5/8 x 6-5/8")
Net weight	2.2 kg (4.9) lbs.)

## Stress-free sanding without cord

Both motor and battery are located above the sanding face to suppress fluttering of the base, enabling to provide an evenly finished surface.



**Battery protector**  
Prevents damage to the battery and work material.



**Detachable front grip**  
Detachable without tools and can be ground close-to-wall.

**Easy-to-operate paper clamp**  
ensures easy installation/removal of paper with rolled clamber's edges.

**Independently replaceable Pad**  
it can be independently replaced as it is fastened to machine's base with screws. And surely saves your repairing cost.



Photo: DBO380

BL MOTOR

## Continuous run time

High speed mode

about 50 min

Battery: BL1860B (on a full battery charge)

## Speed control by push button

3-stage electric speed control: 4,000/ 8,000/ 12,000min<sup>-1</sup>

## Available with Dust bag or Dust box

Also connectable to Makita vacuum cleaners



**Rigid aluminum foot with sponge sleeve**  
provides high durability and effective vibration-absorbing performance.



**9035H Finishing Sander**

Ergonomic tool body for controlled operation

419



Continuous Rating Input	180W
Pad Size	93 x 185 mm (3-5/8" x 7-1/4")
Abrasive Paper Size	93 x 228 mm (3-5/8" x 9")
Orbits Per Minute (OPM)	11,000
Dimensions (L x W x H)	236x93x146mm (9-1/4"x3-5/8"x5-3/4")
Net Weight	1.5kg (3.3lbs)
Power Supply Cord	2.5m (8.2ft)



Abrasive Paper x6

**BO3710 Finishing Sander**

11,000 OPM for increased efficiency and smooth finish sanding

64



Continuous Rating Input	190W
Pad Size	93 x 185 mm (3-5/8" x 7-1/4")
Abrasive Paper Size	93 x 228 mm (3-5/8" x 9")
Orbits Per Minute (OPM)	11,000
Strokes Per Minute (SPM)	22,000
Orbit Diameter	2.0 mm (1/16")
Dimensions (L x W x H)	253x92x154mm (10"x3-5/8"x6-1/16")
Net Weight	1.6 kg (3.5 lbs)
Power Supply Cord	2.0 m (6.6 ft)



Abrasive Paper, Punch Plate, Dust Bag or Dust Box

**DBO481RTJ / Z Cordless Finishing Sander**

18V LXT Li-Ion 1/4 Sheet Finishing Sander

Li-ion Ah 6.0 5.0 3.0 1.5



Pad Size	112x102mm (4-3/8x4")
Abrasive Paper Size	Clamp type: 140 x 114 mm (5-1/2 x 4-1/2")
Orbits Per Minute (OPM)	High:14,000, Low: 11,000 w/BL1830B / BL1850B / BL1860B:
Dimensions (L x W x H)	171 x 112 x 151 mm (6-3/4 x 4-3/8 x 5-15/16")
Net weight	1.4 - 1.7 kg (3.1 - 3.8 lbs.)

DBO481RTJ DBO481Z

18V



Abrasive Paper, Dust Bag / Dust Box, Punch Plate, Z: Battery and Charger are sold separately

**BO4510H 110mm x 100mm (4-5/16 x 3-15/16") Finishing Sander**

Ergonomic tool body for controlled operation

419



Continuous Rating Input	170W
Pad Size	110 x 100 mm (4-5/16" x 3-15/16")
Abrasive Paper Size	114 x 140 mm (4-1/2" x 5-1/2")
Orbits Per Minute (OPM)	12,000
Dimensions (L x W x H)	116x110x129mm (4-9/16"x4-5/16"x5-1/8")
Net Weight	1.1kg (2.4lbs)
Power Supply Cord	2.5m (8.2ft)



Abrasive Paper x6

**BO4556 112mm x 102mm (4-3/8 x 4") Finishing Sander**

Powerful 200W motor, low vibration, low noise

419



Continuous Rating Input	200W
Pad Size	112 x 102 mm (4-3/8" x 4")
Abrasive Paper Size	114 x 140 mm (4-1/2" x 5-1/2")
Orbits Per Minute (OPM)	14,000
Dimensions (L x W x H)	131x112x141mm (5-1/8"x4-3/8"x5-9/16")
Net Weight	1.1kg (2.5lbs)
Power Supply Cord	2.0m (6.6ft)



Abrasive Paper, Dust Bag, Punch Plate

**DBS180Z 9mm Cordless Belt Sander**

Large 533 mm (21") belt length for faster work

Li-ion Ah 6.0 5.0 3.0 1.5



Belt Width	6/9 / 13 mm (1/4 / 3/8 / 1/2")
Belt Length	533 mm (21")
Belt Speed	600 - 1,700 m/min
Max Output	530 W
Dimensions (L x W x H)	w/BL1830B / BL1850B / BL1860B: 500 x 96 x 116 mm (19-3/4 x 3-3/4 x 4-9/16") w/ Side Grip & BL1830B /BL1850B / BL1860B: 500 x 245 x 126 mm (19-3/4 x 9-5/8 x 5")
Net weight	1.8 - 2.1 kg (4.0 - 4.6 lbs.)

18V



Sanding Belt, Grip, Grip Base, Battery, Charger, Z: Battery and Charger are sold separately

**9031 30mm x 533mm (1-3/16" x 21") Belt Sander**

Optimum for use in close quarters or on irregular shapes

411



Continuous Rating Input	550W
Belt Size	30 x 533mm (1-1/8" x 21")
Belt Speed	200 - 1,000m / min. (656 - 3,280ft/ min)
Overall Length	380 mm (15")
Net Weight	2.1kg (4.6lbs)
Power Supply Cord	2.5m (8.2ft)



Abrasive Belts set, Grip

**9924DB 76mm x 610mm (3" x 24") Belt Sander**

Sufficient power, proven reliability and well balanced design

100



Continuous Rating Input	850W
Belt Size	76 x 610, 620mm (3" x 24, 24-3/8")
Belt Speed	400m / min. (1,300ft/ min)
Overall Length	355 mm (14")
Net Weight	4.8kg (10.6lbs)
Power Supply Cord	5.0m (16.4ft)



Abrasive Belt, Carbon Plate, Dust Bag Assembly

# DUST EXTRACTION

## PRODUCTS



### UB001GM201(RMX) / GZ Cordless Blower

Powerful blowing force (Max 17N)

Li-ion 8.0 | 5.0 | 4.0 | 2.5 | 2.0

Max Air Volume	15.8 m <sup>3</sup> /min (554 CFM)
Max Air Velocity	62 m/s (140 MPH)
No Load Speed (RPM)	0-23,000
Dimensions (L x W x H)	850-950 x 167 x 297 mm (33-1/2-37-1/2 x 6-9/16 x 11-3/4")
Net weight	3.1-3.9 kg (6.8-8.6 lbs.)



40Vmax



Shoulder Belt, End Nozzle, Flat Nozzle, Battery, Charger, Z: Battery and Charger are sold separately

### UB003CZ Battery Powered Blower

New

Powerful blowing force (Max 24N)

Max Air Volume	w/ End nozzle, w/ PDC1500, Max speed mode: 17.6 m <sup>3</sup> /min
Max Air Velocity	w/ End nozzle, w/ PDC1500, Max speed mode: 86.0 m/s
Avg. Air Velocity	w/ End nozzle, w/ PDC1500, Max speed mode: 11.7-71.9 m/s
Blowing Force	w/ End nozzle, w/ PDC1500, Max speed mode: 0.7-24 N
No Load Speed (RPM)	Mode1 / Mode2 / Mode3: 4,000-10,600 / 17,700 / 22,100 min <sup>-1</sup>
Dimensions (L x W x H)	w/ Nozzle: 913-1,013 x 178 x 298 mm
Net weight	2.8-3.1 kg (6.2-6.8 lbs.)



End nozzle, Band assembly



High power & Lightweight design

Continuous run time (approx) on a full battery charge with PDC1500

# 60 min

Maximum speed mode or maximum speed with the cruise control lever / With standard nozzle attached

### 1,500Wh-class high capacity

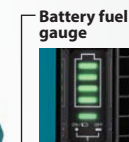

Portable Power Pack PDC1500  
WG WETGUARD

### Nozzle reducing reaction force

The recoil of the machine tilting is reduced with the grip as the fulcrum since the reaction force is directed toward the grip by tilting the nozzle tip downward, therefore, the burden on the user's arm is reduced.

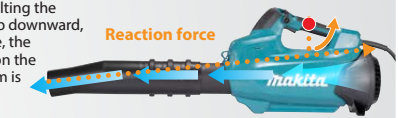

Variable control trigger + Cruise control lever



Battery Powered Blower UB003C



3-stage telescopic long nozzle

UB003C	PDC1500		
Average blowing force	Max air volume	Max air velocity	Charging time 450 min. with DC4001
<b>24 N</b>	<b>17.6 m<sup>3</sup>/min</b>	<b>86.0 m/s</b>	
Maximum speed mode or maximum speed with the cruise control lever, with PDC1500 / With standard nozzle attached			



**UB001CZ Battery Powered Blower**

Powerful blowing force (Max 20N)



Max Air Volume	Cruise Control Mode: 0 - 15.0 m <sup>3</sup> /min Boost Mode: 17.6 m <sup>3</sup> /min
Max Air Velocity	Cruise Control Mode: 0 - 60 m/s Boost Mode: 70
Avg. Air Velocity	Cruise Control Mode: 0 - 50 m/s Boost Mode: 58
Blowing Force	Cruise Control Mode: 0 - 15.0 Boost Mode: 20.0
No Load Speed (RPM)	Cruise Control Mode: 0 - 21,000 Boost Mode: 24,000
Dimensions (L x W x H)	960 x 1,060 x 295 x 180 mm
Net weight	2.6 - 2.9 kg (5.7 - 6.5 lbs.)



Shoulder Belt, End Nozzle

**UB002CZ01 Battery Powered Backpack Blower**

BL Brushless Battery Powered Variable Speed Blower



Max Air Volume	w/ End nozzle: 0 - 19.0 m <sup>3</sup> /min w/ Flat nozzle: 0 - 17.9 m <sup>3</sup> /min
Max Air Velocity	w/ End nozzle: 0 - 71.7 m/s w/ Flat nozzle: 0 - 76.0 m/s
Blowing Force	0 - 22.0 N
No load speed (RPM)	0 - 22,000
Continuous run time on a full battery charge	78 min
Sound power level	95.5 dB(A)
Dimensions (L x W x H)	w/o Nozzle: 267 x 565 x 715 mm (10-1/2 x 22-1/4 x 28-1/8") w/ Nozzle: 1,368 x 694 x 715 mm (54 x 27-1/4 x 28-1/8")
Net Weight	15.9 - 16.1 kg (35.1 - 35.4 lbs.)



Adaptor Pipe, Flat Nozzle, Extension Nozzle

**DUB363ZV Cordless Blower**

Able to use both in Blower and Vacuuming applications

Li-ion Ah 6.0 5.0 3.0 1.5



Max Air Volume	13.4 m <sup>3</sup> /min (473 CFM)
Max Air Velocity	65 m/s
No Load Speed (RPM)	0 - 7,850
Dimensions (L x W x H)	w/ 3-Stage Telescopic Long Nozzle: 737/786/836x200x415 mm (7-7/16"/31") 33"x7-7/8"x16-3/8"
Net weight	4.3 - 6.6 kg (9.4 - 14.6 lbs.)



Vacuum kit, Flat Nozzle, End Nozzle, Pipe, Shoulder Belt, Hex Wrench, Battery, Charger, Z: Battery and Charger are sold separately



**DUB362Z Cordless Blower**

Brushless Cordless Variable 6-Speed Blower

Li-ion Ah 6.0 5.0 3.0 1.5



Capacity (Ah)	5.0 / 6.0
Energy Capacity (Wh)	90x2 / 108x2
Max Air Volume	13.4 m <sup>3</sup> /min (473 CFM)
Max Air Velocity	54 m/s (120 MPH)
No Load Speed (RPM)	11,400 - 21,500
Sound Power Level	93.5 dB(A)
Dimensions (L x W x H)	830/880/930x205x295mm (32-3/4"/34-3/4"/36-5/8") x8-1/8"x11-5/8")
Net weight	3.5 kg (7.7 lbs)



Fast charger, Battery cartridge, Nozzle, Shoulder belt, Z: Battery and Charger are sold separately

**DUB184Z Cordless Blower**

18V LXT BL Brushless Cordless Variable Speed Blower

Li-ion Ah 6.0 5.0 3.0 1.5



Max Air Volume	13.0 m <sup>3</sup> /min (459 CFM)
Max Air Velocity	52.1 m/s (116 MPH)
No Load Speed (RPM)	0 - 18,000
Continuous Use (min.)	w/ BL1860B: 12, w/ BL1850B: 10
Sound Pressure Level	86.6 dB(A)
Sound Power Level	93.5 dB(A)
Dimensions (L x W x H)	w/ BL1830B / BL1850B / BL1860B: 825x160x285mm (32-1/2"x 6-5/16"x11-1/4")
Net weight	2.5 - 3.0 kg (5.4 - 6.7 lbs.)



Shoulder Belt, Nozzle, Battery, Charger, Hex Wrench, Z: Battery and Charger are sold separately

**DUB187Z Cordless Blower Vacuum**

18V LXT BL Cordless Variable Speed Blower Vacuum

Li-ion Ah 6.0 5.0 3.0 1.5



No load speed (RPM)	9,000-13,500
Max air volume (Vacuum)	6.1 m <sup>3</sup> /min
Max sealed suction	3.3 kPa
Dust bag capacity	25 L
Max air volume	Blower: 4.2 m <sup>3</sup> /min Vacuum: 6.1 m <sup>3</sup> /min
Max air velocity	Blower: 64.0 m/s
Max sealed suction	Vacuum: 3.3 kPa
Dimensions (L x W x H)	1,168 x 164 x 416 mm (46 x 6-1/2 x 16-3/8")
Net weight	3.7 - 4.0 kg (8.2 - 8.8 lbs.)



Dust bag, Shoulder belt, Battery, Charger, Z: Battery and Charger are sold separately



Continuous run time (approx.)

**14 min**  
With BL1860B battery



**Vacuum / Blower**

Single action lever for blower / vacuum mode selection

## AS001GZ02 Cordless Dust Blower

Achieves higher blowing force

Li-ion Ah 5.0 4.0 2.5 2.0



Max blowing force	Mode: 4/3/2/1: 2.8/2.3/1.7/1.1 N
Max air volume	Mode: 4/3/2/1: 1.1/1.0/0.8/0.6 m <sup>3</sup> /min
Max sealed suction	10.3 kPa
Continuous Use (min.)	Mode: 4/3/2/1: 13/17/25/50
Sound Pressure Level	79 dB(A)
Vibration Emission	2.5 m/s <sup>2</sup> or less
Dimensions (L x W x H)	w/ BL4020 / BL4025: 180 x 94 x 248 mm (7-1/8 x 3-11/16 x 9-3/4")
Net weight	1.5 - 2.3 kg (3.3 - 5.1 lbs.)

40Vmax



Nozzle 3, Nozzle 7, Nozzle 13, Pinch valve nozzle, Wide range nozzle, Battery, Charger, Z: Battery and Charger are sold separately

## DAS180Z Cordless Dust Blower

18V LXT BL Cordless Air Duster

Li-ion Ah 6.0 5.0 3.0 1.5



Air volume	0-1.1 m <sup>3</sup> /min
Air velocity	0-150 m/s
Air pressure	0-18.0 kPa
Blowing force	Mode 1: 0-1.1 N Mode 4: 0-2.8 N
Max Sealed Suction	9.3 kPa
Continuous Use (min.)	BL1860B, Mode 1: 55 BL1860B, Mode 4: 15
Dimensions (L x W x H)	w/o Battery: 173 x 92 x 247 mm (6-13/16 x 3-5/8 x 9-3/4")
Net weight	1.2 - 1.7 kg (2.6 - 3.7 lbs.)

18V



Nozzle, Pinch valve nozzle, Wide range nozzle, Flexible nozzle, Air vent hose, Rubber attachment, Filter, Belt clip, Battery, Charger, Z: Battery and Charger are sold separately

## DUB186Z Cordless Blower

18V LXT Cordless Variable 3-Speed Blower

Li-ion Ah 6.0 5.0 3.0 1.5



Max Air Volume	3.2 m <sup>3</sup> /min
Max Air Velocity	68 m/s
No Load Speed (RPM)	0 - 18,000
Blowing Force	2.5 N
Sound Power Level	92.4 dB(A)
Dimensions (L x W x H)	w/ BL1815N: 859x156x195 mm (33-3/4"x6-1/8"x7-5/8") w/ BL1830B / BL1850B / BL1860B: 861x156x210 mm (34"x6-1/8"x8-1/4")
Net weight	1.6 - 2.1 kg (3.5 - 4.6 lbs.)

18V



Garden Nozzle, Battery, Charger, Z: Battery and Charger are sold separately

## UB101DZ Cordless Blower

12Vmax CXT Cordless Variable 3-Speed Blower

Li-ion Ah 5.0 4.0 2.0 1.5



Max Air Volume	2.6 m <sup>3</sup> /min
Max Air Velocity	56 m/s
Max Sealed Suction	N/A kPa
No Load Speed (RPM)	0 - 15,800
Blowing Force	1.6 N
Run Time (min)	w/ BL1016, High / Mid / Low: 7 / 20 / 45
Dimensions (L x W x H)	w/ BL1016/BL1021B: 849 x 155 x 184 mm (33-1/2 x 6-1/8 x 7-1/4") w/ BL1041B: 852 x 155 x 202 mm (33-1/2 x 6-1/8 x 8")
Net weight	1.4 - 1.9 kg (3.1 - 4.2 lbs.)

12Vmax



Garden Nozzle, Battery, Charger, DZ: Battery and Charger are sold separately

## DUB185Z Cordless Blower

18V LXT Cordless Variable 3-Speed Blower

Li-ion Ah 6.0 5.0 3.0 1.5



Max Air Volume	3.2 m <sup>3</sup> /min
Max Air Velocity	98 m/s
Max Sealed Suction	5.8 kPa
No Load Speed (RPM)	0 - 18,000
Blowing Force	3.1 N
Sound Power Level	94 dB(A)
Dimensions (L x W x H)	w/ BL1815N: 515x156x195 mm (20-1/4"x6-1/8"x7-5/8") w/ BL1830B / BL1850B / BL1860B: 517x156x210 mm (20-3/8"x6-1/8"x8-1/4")
Net weight	1.6 - 2.1 kg (3.5 - 4.6 lbs.)

18V



Nozzle, Battery, Charger, Z: Battery and Charger are sold separately

## UB100DZ Cordless Blower

12Vmax CXT Cordless Variable 3-Speed Blower

Li-ion Ah 5.0 4.0 2.0 1.5



Max Air Volume	2.6 m <sup>3</sup> /min
Max Air Velocity	75 m/s
Max Sealed Suction	4.0 kPa
No Load Speed (RPM)	0 - 15,800
Blowing Force	1.8 N
Run Time (min)	w/ BL1016, High / Mid / Low: 8 / 20 / 45
Dimensions (L x W x H)	w/ BL1016/BL1021B: 505 x 155 x 184 mm (19-7/8 x 6-1/8 x 7-1/4") w/ BL1041B: 508 x 155 x 202 mm (20 x 6-1/8 x 8")
Net weight	1.4 - 1.9 kg (3.1 - 4.2 lbs.)

12Vmax



Nozzle, Battery, Charger, DZ: Battery and Charger are sold separately

## UB1102 Blower

High output air volume

303



Continuous Rating Input	600W
Air Volume	4.1 m <sup>3</sup> /min
Air Pressure	5.7 kPa
No Load Speed (RPM)	16,000
Dimensions (L x W x H)	479x185x178 mm (18-7/8"x7-1/4"x7")
Net Weight	1.9 - 2.2 kg (4.3 - 4.8 lbs.)
Power Supply Cord	2.5 m (8.2 ft.)



Nozzle Assembly Front Cuffs 24, Poly Bag Set

## UB1103 Blower

High output air volume

303



Continuous Rating Input	600W
Air Volume	0-4.1 m <sup>3</sup> /min
Air Pressure	0-5.7 kPa (0-580 mmH <sub>2</sub> O)
No Load Speed (RPM)	0-16,000
Dimensions (L x W x H)	479x185x178mm (18-7/8"x7-1/4"x7")
Net Weight	2.0kg (4.3lbs)
Power Supply Cord	2.5m (8.2ft)



Nozzle Assembly Front Cuffs 24, Poly Bag Set



**VC006GMZ03 (Wet & Dry) Cordless Vacuum Cleaner**

80Vmax XGT BL AWS Cordless 40L Dust Class M GYUPPA Vacuum Cleaner

Li-ion Ah 8.0 5.0 4.0 2.5 2.0



Capacity	Dust / Water: 40 / 30L
Max Air Flow	w/ Hose 28-3.5: 2.0 m <sup>3</sup> /min w/ Hose 38-2.5: 3.7 m <sup>3</sup> /min
Max Sealed Suction	18 kPa
Suction Power	350 W
Dimensions (L x W x H)	586 x 385 x 598 mm (23 x 15-1/8 x 23-1/2")
Net weight	18.4 - 20.8 kg (40.6 - 45.9 lbs.)

40Vmax x2



Floor nozzle, Straight pipe, Bent pipe, Hose, Dust bag, Corner nozzle, Front cuffs (22, 24), Wireless unit, Cap, Joint, Battery, Charger, Z: Battery and Charger are sold separately

**VC003GLZ (Wet & Dry) Cordless Vacuum Cleaner**

40Vmax BL Cordless 15L Vacuum Cleaner

Li-ion Ah 8.0 5.0 4.0 2.5 2.0



Capacity	Dust / Water: 15 / 12L
Continuous Use (min.)	BL4050F x2: 220
Max Air Flow	3.2 m <sup>3</sup> /min
Max Sealed Suction	23 kPa
Suction Power	310 W
Dimensions (L x W x H)	366 x 334 x 475 mm (14-3/8 x 13-1/8 x 18-3/4")
Net weight	8.3 - 10.2 kg (18.3 - 22.5 lbs.)

40Vmax



Floor Nozzle, Long Sash Nozzle, Telescopic pipe assembly, Bent Pipe, Pipe, Hose, Plastic Dust Bag x10, Filter, Tool Box, Battery, Charger, Z: Battery and Charger are sold separately

Dust class M approved  
Tank capacity  
Dry / Wet  
**40 / 30 L**



photo: VC006GM

**Automatic self-cleaning filter system**

Automatically removes dust adhering to filter even in continuous use, reducing clogging of the filter to suppress decrease in suction power.



**Max air flow**

Hose size:  
ø38mm x 2.5m

**3.7 m<sup>3</sup>/min.**

Hose size:  
ø28mm x 3.5m

**2.0 m<sup>3</sup>/min.**

**Continuous use**

Battery: BL4050F x2

[at dial Min] [at dial Max]

**80 min. 25 min.**



**VC004GLZ (Dry) Cordless Vacuum Cleaner**

40Vmax BL AWS Cordless 15L HEPA GYUPPA Vacuum Cleaner

Li-ion Ah 8.0 5.0 4.0 2.5 2.0



Capacity	Dust: 15 L
Continuous Use (min.)	BL4050F x2: 220
Max Air Flow	1.8 m <sup>3</sup> /min
Max Sealed Suction	23 kPa
Suction Power	205 W
Dimensions (L x W x H)	366 x 334 x 475 mm (14-3/8 x 13-1/8 x 18-3/4")
Net weight	8.5 - 10.4 kg (18.7 - 22.9 lbs.)

40Vmax



Powder Filter H Set, Damper Set, Pre Filter Set, Hose (38mm-2.5m), Cuff Lock, Stopper, Sleeve, Front cuffs (38, 22, 24) Battery, Charger, Wireless Unit, Z: Battery and Charger are sold separately

**DVC150LZ (Wet & Dry) Corded and Cordless Vacuum Cleaner**

Powered by AC and Two 18V Li-Ion Batteries in Series

353

Li-ion Ah 6.0 5.0 3.0 1.5



Capacity	Dust / Water: 15 / 12 L
Max Air Flow	AC / DC: 3.6 / 2.1 m <sup>3</sup> /min
Max Sealed Suction	AC / DC: 24 / 9 kPa
Suction Power	AC / DC: 320 / 25 - 70 W
Vibration Level	2.5 m/s <sup>2</sup> or less
Sound Pressure Level	75 dB(A)
Dimensions (L x W x H)	366x334x421 mm (14-3/8"x13-1/8"x16-1/2")
Net weight	8.9 - 9.6 kg (19.7 - 21.1 lbs.)

18V x2



Floor Nozzle, Corner Nozzle, Straight Pipe, Bent Pipe, Hose (38mm-2.5m), Plastic Dust Bag, Plastic Dust Bag x10, Cloth Filter, Tool Box, Battery, Charger, Z: Battery and Charger are sold separately

**DVC155LZX2 (Wet & Dry) Cordless Vacuum Cleaner**

18V X2 (36V) LXT BL Cordless 15 L Dust Class L Vacuum Cleaner (Wet & Dry)

Li-ion Ah 6.0 5.0 3.0 1.5



Capacity	Dust / Water: 15 / 12 L
Max Air Flow	2.1 m <sup>3</sup> /min
Max Sealed Suction	11 kPa
Suction Power	105 W
Dimensions (L x W x H)	366x334x421 mm (14-3/8"x13-1/8"x16-1/2")
Net weight	7.2 - 7.9 kg (16.1 - 17.4 lbs.)

18V x2



Floor Nozzle, Long Sash Nozzle, Telescopic pipe assembly, Bent Pipe, Pipe, Hose, Plastic Dust Bag x10, Filter, Tool Box, Battery, Charger, Z: Battery and Charger are sold separately

**DVC860LZ (Wet & Dry) Corded and Cordless Vacuum Cleaner**

8L Large dust bag capacity enables continuous cleaning work

353

Li-ion Ah 6.0 5.0 3.0 1.5



Capacity	Dust / Water: 8 / 6 L
Continuous Use (min.)	With BL1850B x 2: 65
Max Air Flow	AC / DC: 3.6 / 2.1 m <sup>3</sup> /min
Max Sealed Suction	AC / DC: 24 / 9 kPa
Suction Power	AC / DC: 320 / 25 - 70 W
Dimensions (L x W x H)	366x334x368mm (14-3/8"x13-1/8"x14-1/2")
Net weight	8.6 kg (19.0 lbs.)

18V x2



Floor Nozzle, Corner Nozzle, Straight Pipe, Bent Pipe, Hose (38mm-2.5m), Plastic Dust Bag, Plastic Dust Bag x10, Cloth Filter, Tool Box, Z: Battery and Charger are sold separately

**DVC865LZX2 (Wet & Dry)**  
Cordless Vacuum Cleaner

18V X2 (36V) LXT BL Cordless 8 L Dust Class L Vacuum Cleaner (Wet & Dry)

Li-ion Ah 6.0 | 5.0 | 3.0 | 1.5



Capacity	Dust/Water: 8/6 L
Max Air Flow	2.1 m <sup>3</sup> /min
Max Sealed Suction	11 kPa
Suction Power	105 W
Dimensions (L x W x H)	366x334x368 mm (14-3/8"x13-1/8"x14-1/2")
Net weight	7.0-7.7 kg (15.7-17.0 lbs.)

18V x2



Floor Nozzle, Long Sash Nozzle, Telescopic pipe assembly, Bent Pipe, Pipe, Hose, Plastic Dust Bag x10, Filter, Tool Box, Battery, Charger, Z: Battery and Charger are sold separately

**DVC867LZX4 (Dry)** Cordless Vacuum Cleaner

18V X2 (36V) LXT BL AWS Cordless 8 L Dust Class L HEPA Vacuum Cleaner (Dry only)

Li-ion Ah 6.0 | 5.0 | 3.0 | 1.5



Capacity	Dust/Water: 8/- L
Max Air Flow	2.4 m <sup>3</sup> /min
Max Sealed Suction	11 kPa
Suction Power	110 W
Dimensions (L x W x H)	366x334x368 mm (14-3/8"x13-1/8"x14-1/2")
Net weight	7.7-8.4 kg (17.2-18.5 lbs.)

18V x2



Floor Nozzle, Corner Nozzle, Straight Pipe, Bent Pipe, Hose (38mm-2.5m), Plastic Dust Bag, Plastic Dust Bag x10, Cloth Filter, Tool Box, Battery, Charger, Wireless Unit, Z: Battery and Charger are sold separately

**DVC560PG2 / Z** Cordless Upright Cleaner

18V X2 (36V) LXT BL Brushless Cordless 5 L HEPA Upright Cleaner

Li-ion Ah 6.0 | 5.0 | 3.0 | 1.5



Capacity	Dust: 5 L
Continuous Use (min.)	w/ BL1860B x2 Max / Normal / Low Noise: 30 / 60 / 120
Max Air Flow	1.9 m <sup>3</sup> /min
Max Sealed Suction	12 kPa
Suction Power	Max / Normal / Low Noise: 85 / 50 / 25 W
Cleaning Width	318 mm
Brushroll Rotation Speed	Max / Normal / Low Noise: 3,500 / 2,500 / 1,000 RPM
Dimensions (L x W x H)	326 x 318 x 1,146 mm (12-7/8 x 12-1/2 x 45")
Net weight	8.3-9.0 kg (18.3-19.8 lbs.)

18V x2



Long Sash Nozzle, Round Brush, Filter Bag, Filter H, Filter Bag Set, Z: Battery and Charger are sold separately

**VC011GZ** Cordless Backpack Vacuum Cleaner

40Vmax XGT BL Brushless Cordless HEPA Backpack Vacuum Cleaner

Li-ion Ah 8.0 | 5.0 | 4.0 | 2.5 | 2.0



Capacity	Paper Dust Bag: 6.0 L Cloth Dust Bag: 5.5 L
Max Air Flow	2.4 m <sup>3</sup> /min
Max Sealed Suction	20 kPa
Continuous use (approx.) on a full battery charge	w/ BL4050F x2: Mode 1/2/3/4: 260 / 130 / 75 / 40 min
Suction Power	Mode 1/2/3/4: 25W / 55W / 100W / 195W w/ BL4040 x2: 301 x 185 x 526 mm (11-7/8 x 7-1/4 x 20-3/4")
Dimensions (L x W x H)	
Net weight	6.4-9.5 kg (14.1-20.9 lbs.)

40Vmax



Hose, Hose band, Dust bag, Switching nozzle, Bent pipe with pipe locking mechanism, Long sash nozzle, Battery, Charger, Z: Battery and Charger are sold separately

**VC008GZ04** Cordless Backpack Vacuum Cleaner

40Vmax XGT BL Brushless Cordless HEPA Backpack Vacuum Cleaner

Li-ion Ah 8.0 | 5.0 | 4.0 | 2.5 | 2.0



Capacity	Paper Dust Bag: 2.0 L Cloth Dust Bag: 1.5 L
Max Air Flow	2.4 m <sup>3</sup> /min
Max Sealed Suction	18 kPa
Suction Power	w/ Hose 32-1.0 (Max): 180 W
Dimensions (L x W x H)	233 x 151 x 376 mm (9-1/8 x 5-15/16 x 14-3/4")
Net weight	4.3-4.7 kg (9.5-10.4 lbs.)

40Vmax



Floor Nozzle, Hose, Hose Band, Nozzle, Telescopic pipe assembly, Bent Pipe, Switching nozzle, Free Nozzle, Dust Bag, Battery, Charger, Z: Battery and Charger are sold separately

**VC009GZ** Cordless Backpack Vacuum Cleaner

40Vmax XGT BL AWS Cordless HEPA Backpack Vacuum Cleaner

Li-ion Ah 8.0 | 5.0 | 4.0 | 2.5 | 2.0



Capacity	Paper Dust Bag: 2.0 L Cloth Dust Bag: 1.5 L
Max Air Flow	1.9 m <sup>3</sup> /min
Max Sealed Suction	18 kPa
Suction Power	w/ Hose 28-1.5, Max / High / Normal: 165 / 85 / 45
Dimensions (L x W x H)	233 x 151 x 376 mm (9-1/8 x 5-15/16 x 14-3/4")
Net weight	4.3-4.7 kg (9.5-10.4 lbs.)

40Vmax



Hose, Hose Band, Dust Bag, Wireless Unit, Battery, Charger, Z: Battery and Charger are sold separately



For Cleaning  
**VC011G**

Powered by  
40Vmax XGT  
Li-Ion battery  
(two in parallel or one)

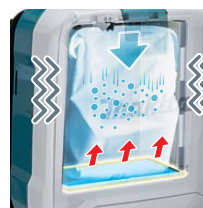

**Telescopic pipe with lock**

- A locking mechanism has been added to the connection of bending pipe and this pipe to prevent from falling off.
- Available in lightweight plastic and rigid aluminum

**Automatic filter cleaning mechanism**

The board with springs located beneath the dust bag rocks due to walking vibration to remove dust from the bag, reducing filter clogging to maintain suction power.

Locking mechanism

Telescoping button

48 mm



Max Suction power	Low noise	Max Sealed Suction
<b>195 W</b> mode: 4 / With ø32mm x 1.0m Hose	<b>55 dB(A)</b> mode: 1	<b>20 kPa</b>



**DVC660ZX7**  
Cordless Backpack Vacuum Cleaner

18V X2 (36V) LXT BL Brushless HEPA Cordless Backpack Vacuum Cleaner

Li-ion Ah 6.0 | 5.0 | 3.0 | 1.5



Capacity	Paper Dust Bag: 6.0 L Cloth Dust Bag: 5.5 L w/ Hose complete 32-1.0: 2.2 m <sup>3</sup> /min w/ Hose Complete 28-1.0: 2.0 m <sup>3</sup> /min
Suction Power	Max / High / Normal w/ Hose 32-1.0: 95 / 50 / 25 W Max / High / Normal w/ Hose 28-1.0: 90 / 45 / 25 W
Vibration Level	Operation w/o Load: 2.5 m/s <sup>2</sup> or less
Dimensions (L x W x H)	297x174x523 mm (11-3/4"x6-7/8"x20-5/8")
Net weight	6.1 - 6.7 kg (13.4 - 14.8 lbs.)

18V x2



Floor Nozzle, Hose, Hose Band, Nozzle assembly, Telescopic pipe assembly, Bent Pipe, Switching nozzle, Free Nozzle, Dust Bag, Front Cuffs (22, 24), Battery, Charger, Z: Battery and Charger are sold separately

**DVC665Z**  
Cordless Backpack Vacuum Cleaner

18V X2 (36V) LXT BL AWS HEPA Cordless Backpack Vacuum Cleaner

Li-ion Ah 6.0 | 5.0 | 3.0 | 1.5



Capacity	Paper Dust Bag: 6.0 L Cloth Dust Bag: 5.5 L w/ Hose Complete 28-1.5: 1.8 m <sup>3</sup> /min
Max Air Flow	High / Normal w/ Hose 28-1.5: 85 / 45 W
Suction Power	Operation w/o Load: 2.5 m/s <sup>2</sup> or less
Vibration Level	2.5 m/s <sup>2</sup> or less
Dimensions (L x W x H)	297x174x523 mm (11-3/4"x6-7/8"x20-5/8")
Net weight	6.1 - 6.7 kg (13.5 - 14.9 lbs.)

18V x2



Floor Nozzle, Hose, Hose Band, Nozzle assembly, Telescopic pipe assembly, Bent Pipe, Switching nozzle, Free Nozzle, Dust Bag, Front Cuffs (22, 24), Battery, Charger, Z: Battery and Charger are sold separately

**VS001GZ** Cordless Vacuum Sweeper

New

40Vmax XGT BL Cordless 24 L Dust Class HEPA Vacuum Sweeper

Li-ion Ah 8.0 | 5.0 | 4.0 | 2.5 | 2.0



Dust container capacity	24 L (6.3 gal)
Continuous use (approx.) on a full battery charge	w/ BL4080F x2: 150 min
Charging time approx.	w/ BL4080F-x2, w/ DC40RA: 120 min
Sweeping capacity	2,600 m <sup>2</sup> /h
Cleaning width	Main brush: 480 mm (18-7/8"), Side brush: 650 mm (25-1/2")
Dimensions (L x W x H)	w/ Handle in upright position: 830 x 677 x 1,146 mm (32-3/4 x 26-3/4 x 45")
Net weight	31-34 kg (68.3-74.9 lbs.)

40Vmax



Battery, Charger, Z: Battery and Charger are sold separately

**DRC300Z** Robotic Cleaner

18V LXT BL Brushless Robotic Cleaner w/ Mapping Function

Li-ion Ah 6.0 | 5.0 | 3.0 | 1.5



Continuous Use (min.)	w/ BL1860B x2: 240
Max cleaning area	w/ BL1860B x2: 600 m <sup>2</sup>
Max running speed	0.3 m/sec
Dust Box Capacity	3.0 L
Dimensions (L x W x H)	500 x 500 x 204 mm (19-3/4 x 19-3/4 x 8")
Net weight	9.6 - 10.6 kg (21.2 - 23.4 lbs.)

18V x2



Wireless remote controller (including two AAA alkaline batteries), Side Brush, Z: Battery and Charger are sold separately

Maximum cleaning area 600m<sup>2</sup> with mapping feature

**BL MOTOR** HEPA filter

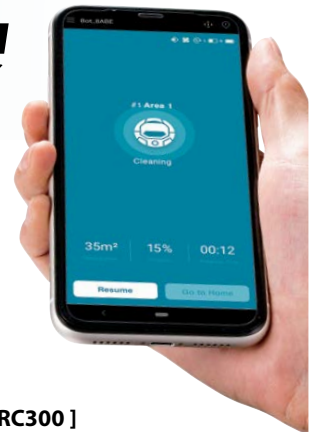

Automatic return to initial position



The number of rooms that can be memorized is 5



Compatible with Smartphone app [ Makita RoboPro DRC300 ]

Dust box capacity **3L**

Continuous run time (approx.) on a full battery charge

**240 min**  
[with two BL1860B batteries]



**LiDAR sensor**

+

**Camera sensor**

photo: DRC300

Equipped with LiDAR sensor (2D) and Camera sensor, the cleaner can map and memorize the rooms to clean.



**DCL184Z Cordless Cleaner**

**18V LXT Li-Ion Cordless 3-Speed Cleaner**

Li-ion Ah 6.0 | 5.0 | 3.0 | 1.5



Capacity	Cloth / Paper Dust Bag: 500 / 330 mL
Continuous Use(min.)	Max / High / Normal: 33 / 50 / 133
Max Air Flow	Cleaning: 1.4 m3/min Blowing: 0.8 m3/min
Max Air Velocity	Blowing: 7.2 m/s
Max Sealed Suction (water column)	5.4 kPa (550 mmH <sub>2</sub> O)
Noise Level	Max / High / Normal: 68 / 65 / 58 dB(A)
Dimensions (L x W x H)	w/ BL1830B / BL1850B / BL1860B: 365x138x202 mm (14-3/8"x5-7/16"x8")
Net weight	1.8 - 2.2 kg (4.0 - 4.9 lbs.)

18V 1

Seat Nozzle, Mat Nozzle, Rubber Nozzle, Soft Brush, Blower Attachment, Dust Bag, Paper Dust Bag, Shoulder Belt, Battery, Charger, Z: Battery and Charger are sold separately

**DVC750LZX1 Cordless Portable Vacuum Cleaner**

Compact, portable and easy-to-use

Li-ion Ah 6.0 | 5.0 | 3.0 | 1.5



Capacity	Dust / Water : 7.5 / 4.5 L
Continuous Use (min.)	w/ BL1850B (High) : 30 w/ BL1850B (Normal) : 60
Max Air Flow	1.3 m <sup>3</sup> /min
Max Sealed Suction	6.7 / 4.2 kPa
Suction Power	High / Low : 50 / 25 W
Dimensions (L x W x H)	418x251x278 mm (16-1/2"x9-7/8"x11")
Net weight	4.3 - 4.6 kg (9.4 - 10.1 lbs.)

18V 1

Hose, Floor Nozzle, Sash Nozzle, Z: Battery and Charger are sold separately

**VC3210L Vacuum Cleaner (Wet & Dry)**

Complying with dust class L

173

110V   
**VC3210L/B**



Continuous Rating Input	1,050W
Max Peak Air Flow	2.0m <sup>3</sup> /min
Max Sealed Suction (Water Column)	22.0 kPa (2,240 mmH <sub>2</sub> O)
Tank Capacity	Dust: 32 L Water: 27 L
Dimensions (L x W x H)	552x398x685mm (21-3/4"x15-5/8"x27")
Net Weight	14.5kg (32.0lbs)
Power Supply Cord	5.0m (16.4ft)

1

Hose Complete 28-3.5 (with Front Cuffs 38), Holder 10-33, Front Cuffs 22, Front Cuffs 24, Poly Bag Set

**Dust classes in accordance with the EU standard**

Since 1997, hazardous dusts have been categorized into 3 ( three ) classes, namely, Class L, Class M and Class H, which is regulated by IEC60335-2-69 ( world wide ) and by EN 60335-2-69. The vacuum cleaners suitable for each of dust class have been also defined by these regulations as follows :

Dust class	Model No.	Definition Of Dust	Major requirement	Dust permeability %
H	VC3211H	*OEL values >0.1mg/m <sup>3</sup> all kinds of dusts caused cancer, disease.	• Air flow sensor • Filter protection structure *1 • Structure that requires a tool for filter removal/installation *2 • Structure that protects users from exposure to dust when emptying dust bag *3	less than 0.005%
M	VC3211M, VC2211M, VC4210M, VC3012M,	*OEL values >0.1mg/m <sup>3</sup> as well as saw dust	• Air flow sensor • Filter protection structure *1	less than 0.1%
L	VC1310L, VC2510L, VC3210L, DVC860L, DVC861L, DVC865L, DVC866L, DVC867L, DVC750L, DVC150L, DVC151L, DVC155L, DVC156L, DVC157L, VC4210L, VC2012L, VC2512L, VC3011L, VC3012L	*OEL values >1mg/m <sup>3</sup>		less than 1%

**HEPA filter**

Apart from the above standard regulated by IEC/EN 60335-2-69, "HEPA" is widely recognized as one of famous guidelines of the filtration efficiency.

According to this standard, the filter of "HEPA" should remove more than 99.75% of airborne particles of 0.3µm in diameter.

Thus, it stipulates only a filtration efficiency of the filter itself, while IEC/EN60335-2-69 defines the vacuum machine suitable for each dust class (construction, mechanical strength of machine) as well as its dust permeability. In this sense, Dust Class H vacuum cleaner does not always have to be equipped with HEPA filter as long as it meets the requirements of IEC/EN60335-2-69. Another difference between HEPA testing methods and the IEC/EN60335-2-69 is the dust loading.

Filter elements for dust classes M and H are to be tested with the limestone dust particles in large quantities for checking the physical strength of filter, while HEPA tests are done with very small liquid droplets.

\* OEL : Occupation Exposure Limit

In dirty indoor environment with high activity, such as schools, the average values of OEL are measured 0.5mg/m<sup>3</sup>. In case of "non-activity place", 0.15mg/m<sup>3</sup> in office and 0.2mg/m<sup>3</sup> in school are measured in average.

\*1 Filters should be protected from sharp objects such as nails when they are accidentally sucked up. The solution for VC3211M/ VC3211H is a protector for the filter units.

\*2 Filters loaded with dust should not be easily removed. The solution for VC3211H is a screw that locks the filter unit lock lever to the lock plate.

\*3 Dust should be prevented from flying around when emptying dust bags or replacing filters. The solution for VC3211H is the filter bag already available as an optional accessory of VC3211M.

\*4 Permeability of limestone (marble) particles having a diameter of 5 microns or less, in accordance with the EU standard



**VC2510L Vacuum Cleaner (Wet & Dry)**

Complying with dust class L

173



Continuous Rating Input	1,050W
Max Peak Air Ow	2.0m <sup>3</sup> /min
Max Sealed Suction (Water Column)	22.0 kPa (2,240 mmH <sub>2</sub> O)
Tank Capacity	Dust: 25 L Water: 14 L
Dimensions (L x W x H)	432x416x451 mm (17"x16-3/8"x17-3/4")
Net Weight	10.5kg (23.2lbs)
Power Supply Cord	5.0m (16.4ft)



Hose Complete 28-3.5 (with Front Cuffs 38), Holder 10-33, Front Cuffs 22, Front Cuffs 24, Plastic Dust Bag Set

**VC2000L Vacuum Cleaner (Wet & Dry)**

Wet & Dry L-class Vacuum Cleaner



Continuous rating Input	1,000W
Max. peak air flow	216 m <sup>3</sup> / h
Max. sealed suction	21 kPa
Tank capacity	Dust: 20L Water: 13L
Dimensions (L x W x H)	375x 385 x 505mm (14-7/6" x 15-1/5" x 19-8/8")
Net Weight	7.5kg (16.5lbs)
Power supply cord	5.0m (16.4ft)



Filter Bag - Fleece, Disposal Bag - Plastic, Suction Hose, Suction Tube, Hand tube, Floor Nozzle, Nozzle Universal, Crevice Nozzle

**CL001GD115(RD/T+B) / GZ04(Z/T+B) / GZ12(Z/T+W) Cordless Cleaner**

40Vmax XGT BL Brushless Cordless 4-Speed Cleaner with LED Light

Li-ion Ah 8.0 5.0 4.0 2.5 2.0



Capacity	730 mL
Continuous Use (min.)	w/BL4040, 1/2/3/4: 128/64/40/25
Max Air Flow	1.2 m <sup>3</sup> /min
Max Sealed Suction (water column)	21 kPa (2,100 mmH <sub>2</sub> O)
Suction Power	w/Easy Shake Off Filter, 1/2/3/4: 20/45/70/125 W
Dimensions (L x W x H)	w/BL4020/BL4025: 1,066 x 113 x 152 mm w/BL4040: 1,081 x 113 x 152 mm
Net weight	1.7-2.3 kg (3.5-5.1 lbs.)



Floor Nozzle, Sash Nozzle, Sash Nozzle Holder, Pipe, Filter H, Easy Shake Off Filter, Battery, Charger, Z: Battery and Charger are sold separately

**CL002GZ03(ZB) / GZ07(ZW) Cordless Cleaner**

40Vmax XGT BL Brushless Cordless 4-Speed Cleaner with LED Light

Li-ion Ah 8.0 5.0 4.0 2.5 2.0



Capacity	Dust Bag: 500 mL Paper Pack: 330 mL
Continuous Use (min.)	w/BL4025, 1/2/3/4: 80/40/25/16
Max Air Flow	1.2 m <sup>3</sup> /min
Max Sealed Suction (water column)	21 kPa (2,100 mmH <sub>2</sub> O)
Suction Power	125 W w/Easy Shake Off Filter, 1/2/3/4: 20/45/70/125 W
Dimensions (L x W x H)	505 x 114 x 152 mm (19-7/8 x 4-1/2 x 6")
Net weight	1.8-3.0 kg (4.0-6.6 lbs.)



Floor Nozzle, Sash Nozzle, Sash Nozzle Holder, Pipe, Easy Shake Off Dust Bag, Paper Dust Bag, Hand Strap, Battery, Charger, Z: Battery and Charger are sold separately

**CL003GD115(RDB) / GD114(RDW) / GZ09(ZB) / GZ14(ZW) Cordless Cleaner**

40Vmax XGT BL Brushless Cordless Cleaner

Li-ion Ah 8.0 5.0 4.0 2.5 2.0



Capacity	250 mL
Continuous use	w/BL4025, Mode 1/2/3/4: 4:80/40/25/16 min
Max air flow	1.0 m <sup>3</sup> /min
Max sealed suction	20 kPa (2,000 mmH <sub>2</sub> O)
Suction power	w/Easy shake off filter EX, Mode 1/2/3/4: 15/35/60/100 W
Noise level	Mode 1/2/3/4: 54/59/62/65 dB(A)
Dimensions (L x W x H)	w/Pipe & Nozzle, w/BL4040: 1,121 x 113 x 177 mm (44-1/4 x 4-7/16 x 7")
Net weight	1.9-2.5 kg (4.2-5.5 lbs.)



Floor Nozzle, Sash Nozzle, Sash Nozzle Holder, Pipe, Battery, Charger, Z: Battery and Charger are sold separately

**DCL286FRTB / FZB Cordless Cleaner**

18V LXT BL Cordless 4-Speed Cleaner with LED Light

Li-ion Ah 6.0 5.0 3.0 1.5



Dust collecting type	Cyclone
Capacity	250 mL
Max Air Flow	1.0 m <sup>3</sup> /min
Max Sealed Suction	18 kPa
Suction power	w/ High performance filter, Mode 1/2/3/4: 15W/35W/60W/100W
Dimensions (L x W x H)	543 x 113 x 177 mm (21-3/8 x 4-7/16 x 7")
Net weight	1.6-1.9 kg (3.5-4.2 lbs.)



Floor nozzle, Sash nozzle, Sash nozzle holder, Pipe, Battery, Charger, Z: Battery and Charger are sold separately

**DCL283FRTB / FZB Cordless Cleaner**

18V LXT BL Cordless Cleaner with LED Light

Li-ion Ah 6.0 5.0 3.0 1.5



Capacity	730 mL
Max Air Flow	1.1 m <sup>3</sup> /min
Max Sealed Suction	17.5 kPa
Suction power	90 W
Dimensions (L x W x H)	503 x 113 x 154 mm (19-3/4 x 4-7/16 x 6-1/8")
Net weight	1.3-1.6 kg (2.9-3.5 lbs.)



Floor nozzle, Sash nozzle, Sash nozzle holder, Pipe, High performance dust bag, Battery, Charger, Z: Battery and Charger are sold separately

**DCL284FRTB / FZB Cordless Cleaner**

18V LXT BL Cordless 4-Speed Cleaner with LED Light

Li-ion Ah 6.0 5.0 3.0 1.5



Capacity	730 mL
Max Air Flow	1.2 m <sup>3</sup> /min
Max Sealed Suction	18 kPa
Suction power	w/ High performance filter, Mode 1/2/3/4: 20W/45W/70W/125W
Dimensions (L x W x H)	503 x 113 x 153 mm (19-3/4 x 4-7/16 x 6-1/16")
Net weight	1.3-1.6 kg (2.9-3.5 lbs.)



Floor nozzle, Sash nozzle, Sash nozzle holder, Pipe, High performance filter, Battery, Charger, Z: Battery and Charger are sold separately

photo: DCL283F



Trigger switch

photo: DCL284F



One-touch switch

photo: DCL286F

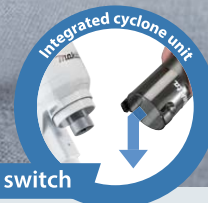

One-touch switch

**High suction power and Low noise level**

- Achieved by redesigning the exhaust air flow path of the motor to reduce wind noise.
- Equipped with high-speed BL motor to ensure high suction power.

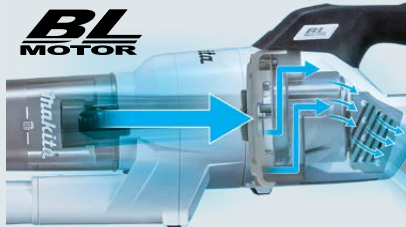

**Low noise**

- DCL283F **63 dB(A)**
- DCL284F **65** [Mode 4] dB(A)
- DCL286F **66** [Mode 4] dB(A)

**Redesigned Floor/ Carpet T-nozzle**

- Redesigned structure reduces the resistance caused by suction, providing smooth running.
- Redesigned inside air flow path reduces the noise made inside the nozzle.



**DCL280FZB Cordless Cleaner**

18V LXT BL Brushless Cordless Cleaner with LED Light

Li-ion Ah 6.0 5.0 3.0 1.5



Capacity	750 mL
Continuous Use (min.)	with BL1830B (High): 20
Max Air Flow	1.4 m <sup>3</sup> /min
Max Sealed Suction (water column)	6.4 kPa (640 mmH <sub>2</sub> O)
Dimensions (L x W x H)	1,016 x 113 x 155 mm (40" x 4.7" x 6.1" - 1/8")
Net weight	1.2 - 1.6 kg (2.7 - 3.5 lbs.)

DCL280FZB

18V

Floor Nozzle, Sash Nozzle, Sash Nozzle Holder, Pipe, Filter H, Easy Shake Off Filter, Hand Strap, Battery, Charger, Z: Battery and Charger are sold separately

**CL106FDSA / FDZ Cordless Cleaner**

12Vmax CXT Li-Ion Cordless Cleaner

Li-ion Ah 5.0 4.0 2.0 1.5



Capacity	600 mL
Continuous Use (min.)	with BL1041B: 42
Max Air Flow	1.3 m <sup>3</sup> /min
Max Sealed Suction (water column)	3.1 kPa (316 mmH <sub>2</sub> O)
Dimensions (L x W x H)	958 x 100 x 150 mm (37.3" x 3.9" x 5.9" - 1/8")
Net weight	1 - 1.1 kg (2.1 - 2.5 lbs.)

12Vmax

Floor Nozzle, Sash Nozzle, Sash Nozzle Holder, Pipe, Battery, Charger, Filter, Prefilter, DZ: Battery and Charger are sold separately

**CL100DW Cordless Cleaner**

Lightweight but with strong suction power (14W)

Li-ion Ah 1.3



Capacity	600 mL
Continuous Use (min.)	12
Max Air Flow	1.2 m <sup>3</sup> /min
Max Sealed Suction (water column)	2.3 kPa (235 mmH <sub>2</sub> O)
Dimensions (L x W x H)	966 x 103 x 150 mm (38.1" x 4.1" x 5.9" - 1/8")
Net weight	0.88 kg (1.94 lbs)

10.8V

Battery Charger, Battery Cartridge, Nozzle Assembly, Sash Nozzle, Pipe, Filter (factory-mounted), Pre-filter (factory-mounted), DZ: Battery and Charger are sold separately

**DVC350Z Cordless Vacuum Cleaner**

Limited Qty

Cordless design for high portability

Li-ion Ah 6.0 5.0 3.0 1.5



Max Air Flow	1.4 m <sup>3</sup> /min
Max Sealed Suction (water column)	6.0 kPa (612 mmH <sub>2</sub> O)
Recoverable capacity	Dust: 3.0 L (0.8 gal)
Dimensions (L x W x H)	273 x 195 x 226 mm (10.7" x 7.7" x 8.9" - 1/8")
Net weight	2.2 - 2.4 kg (4.8 - 5.3 lbs)

18V

Nozzle Assembly, Dust Bag Assembly, Hose Complete, Shoulder Belt, Z: Battery and Charger are sold separately



**Capsule type**



**One touch switch**



**CL001G** **40Vmax**

Easy shake off dust filter

**BL** **HEPA** filter

Max Air Flow **1.2m<sup>3</sup>/min** Max Sealed Suction **21 kPa**

**DCL284F** **18V**

Easy shake off dust filter

**BL** **HEPA** filter

Max Air Flow **1.2m<sup>3</sup>/min** Max Sealed Suction **18 kPa**

- Home
- Building
- Built-in Job Light
- Electronic 2-Speed
- Electronic 3-Speed
- Electronic 4-Speed

**Paper bag type**



**One touch switch**



**CL002G** **40Vmax**

Easy shake off dust bag

**BL** **HEPA** filter

Max Air Flow **1.2m<sup>3</sup>/min** Max Sealed Suction **21 kPa**

**Cyclone attachment**



- Cyclone pre-separation system separates dust from air.
- Easy disposal of the fine dust collected in dust case.
- The main unit of the cleaner requires much less frequent dust disposal.

**Capsule type**



**Trigger switch**



**DCL283F** **18V**

Easy shake off dust filter

**BL** **HEPA** filter

Max Air Flow **1.1m<sup>3</sup>/min** Max Sealed Suction **17.5 kPa**

**DCL280F** **18V**

Easy shake off dust filter

**BL** **HEPA** filter

Max Air Flow **1.4m<sup>3</sup>/min** Max Sealed Suction **6.4 kPa**

**CL106FD** **12Vmax**

Max Air Flow **1.3m<sup>3</sup>/min** Max Sealed Suction **3.1 kPa**

**Cyclone unit**



**One touch switch**



**CL003G** **40Vmax**

High performance filter set

**BL** **HEPA** filter

Max Air Flow **1.0m<sup>3</sup>/min** Max Sealed Suction **20 kPa**

**DCL286F** **18V**

High performance filter set

**BL** **HEPA** filter

Max Air Flow **1.0m<sup>3</sup>/min** Max Sealed Suction **18 kPa**



# POWER CUTTER

## PRODUCTS



### CE002GZ (Dry) 355mm (14") Cordless Power Cutter

40Vmax X2 (80Vmax) XGT BL AFT AWS Cordless 355 mm Power Cutter, Electric Brake

Li-ion Ah 8.0 | 5.0 | 4.0 | 2.5 | 2.0



Wheel Diameter	355 mm (14")
Max Cutting Capacity	127 mm (5")
No Load Speed (RPM)	4,200
Dimensions (L x W x H)	w/ BL4040: 825 x 272 x 487 mm (32-1/2 x 10-3/4 x 19-1/4")
Net weight	13.1 - 15.1 kg (28.9 - 33.3 lbs.)

40Vmax x2



XGT BL AFT AWS



Wrench, Ring, Hose clamp, Battery, Charger, Z: Battery and Charger are sold separately

### CE001GZ01 (Wet & Dry) 355mm (14") Cordless Power Cutter

40Vmax X2 (80Vmax) XGT BL Cordless 355 mm Power Cutter, Electric Brake

Li-ion Ah 8.0 | 5.0 | 4.0 | 2.5 | 2.0



Wheel Diameter	355 mm (14")
Max Cutting Capacity	127 mm (5")
No Load Speed (RPM)	5,300
Dimensions (L x W x H)	w/ BL4040: 786 x 272 x 433 mm (31 x 10-3/4 x 17")
Net weight	12.3 - 14.1 kg (27.1 - 31.1 lbs.)

40Vmax x2



XGT BL AFT WG XPT



Hex Wrench, Flange, Water Hose Connector, Z: Battery and Charger are sold separately

# PRESSURE WASHER

## PRODUCTS



### HW001GZ Cordless High Pressure Washer

New

Powered by 40Vmax XGT Li-Ion battery (two in parallel or one)

Li-ion Ah 8.0 | 5.0 | 4.0 | 2.5 | 2.0



Max Pressure	11.5 MPa
Max Flow Rate	7.0 L/min
Pump Speed (RPM)	Mode 1/Mode 2/Mode 3: 1,870/2,580/3,350 w BL4050F:
Continuous use (approx) on fully charged batteries	Mode 1: 60 min Mode 2: 30 min Mode 3: 18 min
Max Feed Temperature	40 °C
High Pressure Hose Length	5 m (16 ft.)
Dimensions (L x W x H)	344x383x520 mm
Net weight	8.5 kg (18.7 lbs.)

40Vmax



XGT BL WG



Z: Battery and Charger are sold separately

### DHW080ZK Cordless High Pressure Washer

18V X2 LXT BL Cordless 8 MPa High Pressure Washer

Li-ion 6.0 | 5.0 | 3.0 | 1.5



Max Pressure	8.0 MPa (N/A bars)
Max Flow Rate	380 L/h (6.3 L/min)
Pump Speed (RPM)	High / Low: 3,450 / 2,390
Max Feed Temperature	40 °C (N/A °F)
Max Suction Height	1 m (3.3 ft.)
High Pressure Hose Length	5 m (16 ft.)
Sound Power Level	70.9 dB(A)
Dimensions (L x W x H)	438x218x269 mm (17-1/4"x8-5/8"x10-5/8")
Net weight	7.1 - 7.7 kg (15.6 - 17.0 lbs.)

18V x2



Trigger Gun, High Pressure Hose 5 m, Suction Hose, Cleaner Pin, Storage Box, Variable nozzle, Connector, One touch joint, Battery, Charger, Z: Battery and Charger are sold separately



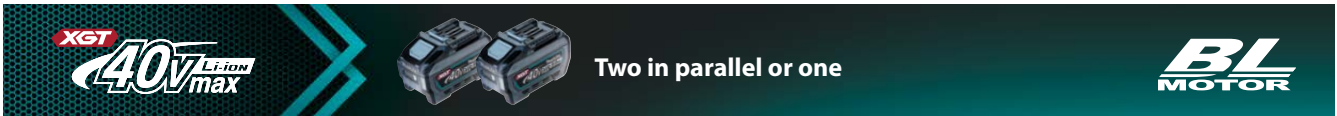

Two in parallel or one



**Good mobility and transportability**



**Large diameter wheels**  
Equipped with  $\phi 140\text{mm}$  wheels, allowing for good mobility even on bumpy road surfaces.

Max permissible pressure **11.5** MPa



**3 operation modes;** operation mode can be selected to suit the contamination degree of the object to be cleaned.



**Accessory storage**

Side section: Trigger gun  
Rear section: High pressure hose, Foam nozzle, Lance

**NEW Foam nozzle set**



**Telescopic handle**

for easy transportation and storage



**Self-priming function**



**HW102 High Pressure Washer**

Lightweight and compact power washer for home use



Continuous Rating Input	1,300W
Max Pressure	100bar (1,450 PSI)
Max Flow Rate	360 L/hr
Motor Type	Universal
Sound Power Level	94dB(A)
Max Input Temperature	50°C
High Pressure Hose	5m
Length	
Net Weight	5.8kg (5.0lbs)



**HW1300 High Pressure Washer**

High Pressure Washer with Self-Priming Function



Continuous Rating Input	1,800W
Max Pressure	13MPa
Max Flow Rate	450 L/hr
Max Feed Temperature	40 °C (104 °F)
Sound Pressure Level	76 dB(A)
High Pressure Hose	10m
Length	
Dimensions	292x358x830 mm (11-1/2"x14-1/8"x32-3/4")
Net Weight	12.7 kg (28.0 lbs.)
Cord Length	5m



Trigger Gun, Vario-Power Spray Lance, Cyclone jet nozzle, Detergent Bottle, Cleaner Pin, Coupling Sleeve, High Pressure Hose 10 m, Water Hose Connector, Foam Nozzle, Connector

**HW132 High Pressure Washer**

Steel reinforced spray gun



Continuous rating input	2,100W
Max Pressure	14 MPa (140 bar, 2,030 PSI)
Net weight	18.8 kg (41.4 lbs)



**HW151 High Pressure Washer**

Compact design, large operating range and efficient cleaning performance



Continuous Rating Input	2,500W
Max Pressure	15MPa (2,175 PSI)
Max Flow Rate	500 L/hr
Motor Type	Induction
Sound Power Level	88dB(A)
Max Input Temperature	50°C
High Pressure Hose	10m(32.8ft)
Length	
Net Weight	26.9kg (23.3lbs)



# HEAT GUN

## PRODUCTS



### DHG181ZK Cordless Heat Gun

Max 550 degrees Celsius air temperature for a wide range of cordless works

Li-ion 6.0 5.0 3.0 1.5



**Air Temperature (°C)** 550°C  
**Air Flow** Stage 1: 120 L/min  
 Stage 2: 200 L/min  
**Dimensions (L x W x H)**  
 w/o Battery: 173 x 79 x 208 mm (6-3/16 x 3-1/8 x 8-3/16")  
 w/ BL1815N / BL1820B: 173 x 79 x 237 mm (6-3/16 x 3-1/8 x 9-3/8")  
 w/ BL1830B / BL1850B / BL1860B: 173 x 79 x 255 mm (6-3/16 x 3-1/8 x 10")  
**Net weight** 1.0 - 1.3 kg (2.2 - 2.9 lbs.)

18V



2

Glass protection nozzle, Wide slot nozzle, Reflector nozzle, Reduction nozzle, Battery, Charger, Z: Battery and Charger are sold separately

### DHG180ZK Cordless Heat Gun

Max 550 degrees Celsius air temperature for a wide range of cordless works

Li-ion 6.0 5.0 3.0 1.5



**Air Temperature (°C)** 550°C  
**Air Flow** 200 L/min  
**Dimensions (L x W x H)**  
 w/o Battery: 168 x 79 x 205 mm (6-5/8 x 3-1/8 x 8-1/8")  
 w/ BL1815N / BL1820B: 168 x 79 x 234 mm (6-5/8 x 3-1/8 x 9-1/4")  
 w/ BL1830B / BL1850B / BL1860B: 168 x 79 x 251 mm (6-5/8 x 3-1/8 x 9-7/8")  
**Net weight** 1.0 - 1.3 kg (2.2 - 2.9 lbs.)

18V



2

Glass protection nozzle, Wide slot nozzle, Reflector nozzle, Reduction nozzle, Battery, Charger, Z: Battery and Charger are sold separately

### Wide Variety of Accessories

#### Glass protection nozzle

Part No. PR00000028



#### Wide-slot nozzle

Part No. PR00000029



#### Reflector nozzle

Part No. PR00000030



#### Reduction nozzle 20

Part No. PR00000031



#### Overlap welding nozzle

Part No. PR00000032



#### Solder sleeves reflector

Part No. PR00000033



#### Welding nozzle

Part No. PR00000034



#### Pressure roller

Part No. PR00000035



#### Scraper

Part No. PR00000040



#### Scraper set

Part No. PR00000041

Part No. PR00000042

Part No. PR00000042



Maximum  
550°C air  
temperature

Max. Air Flow  
**200**  
L/min

Photo : DHG181



### HG5030 Heat Gun

2-temperature settings (350 and 500 °C) for a variety of applications



**Continuous rating input** 1,600W  
**Air Temperature (°C) / Flow (L/min)** Switch 1: 350 / 300  
 Switch 2: 500 / 500  
**Dimensions (L x W x H)** 233x80x208 mm (9-1/8"x3-1/8"x8-3/16")  
**Net weight** 0.56 kg (1.2 lbs.)  
**Power supply cord** 2.0 m (6.6 ft)



4

### HG6030K Heat Gun

2-speed blower settings (250 and 500 L/min) for greater versatility



**Continuous rating input** 1,800W  
**Air Temperature (°C) / Flow (L/min)** Switch 1: 50 / 250  
 Switch 2: 300 / 250  
 Switch 3: 600 / 500  
**Dimensions (L x W x H)** 233x80x208 mm (9-1/8"x3-1/8"x8-3/16")  
**Net weight** 0.57 kg (1.3 lbs.)  
**Power supply cord** 2.0 m (6.6 ft)



2





HG6031VK Heat Gun

2-speed blower settings (250 and 500 L/min) for greater versatility



Continuous Rating Input	1,800W
Air Temperature (°C)	High: 600 Low: 300 Medium: 50
Flow (L/min)	High: 500 Low: 250 Medium: 250
Dimensions (L x W x H)	257x85x206 mm (10-1/8"x3-3/8"x8-1/8")
Net Weight	0.67 kg (1.5 lbs)
Power Supply Cord	2.0 m (6.6 ft)



Glass protection nozzle, Reflector nozzle, Reduction nozzle, Wide slot nozzle

HG6530VK Heat Gun

Durable and powerful heat gun with variable temperature control and LCD display



Continuous rating input	2,000W
Air Temperature (°C)	50 - 650
Air Flow	Stage 1: 280 L/min Stage 2: 280 L/min Stage 3: 550 L/min
Dimensions (L x W x H)	253x85x205 mm (10"x3-3/8"x8-1/8")
Net weight	0.73 kg (1.6 lbs.)
Power supply cord	2.0 m (6.6 ft)



Glass protection nozzle, Wide slot nozzle, Reflector nozzle (Nozzle B)

HG6531CK Heat Gun

Durable and powerful heat gun with variable temperature control and LCD display



Continuous rating input	2,000W
Air Temperature (°C)	50 - 650
Air Flow	200 - 550 L/min
Dimensions (L x W x H)	257x85x206 mm (10-1/8"x3-3/8"x8-1/8")
Net weight	0.71 kg (1.6 lbs.)
Power supply cord	2.0 m (6.6 ft)



Glass protection nozzle, Wide slot nozzle, Reflector nozzle (Nozzle B)

NAILER

PRODUCTS



PT001GD201(RD2K) / GZ Cordless Pin Nailer

40Vmax XGT BL 23 GA 35 mm (1-3/8") Pin Nailer

Li-ion Ah 8.0 | 5.0 | 4.0 | 2.5 | 2.0



Capacity	Length: 15, 18, 25, 30, 35 mm (5/8, 11/16, 1, 1-3/16, 1-3/8") Dia.: 0.6 mm (1/32") Gauge: 23 Ga
Magazine Capacity	120
Dimensions (L x W x H)	218 x 86 x 226 mm (8-5/8 x 3-3/8 x 8-7/8")
Net weight	2.4 - 3.0 kg (5.3 - 6.6 lbs.)

40Vmax



Nose Adapter, Safety Goggles, Belt Clip, Hex Wrench, Battery, Charger,  
Z: Battery and Charger are sold separately

DPT353RTE / Z Cordless Pin Nailer

Shoots 6,400 nails on a single full BL1860B charge

Li-ion Ah 6.0 | 5.0 | 3.0 | 1.5



Capacity	Length: 15, 18, 25, 30, 35 mm (5/8", 11/16", 1-3/16", 1-3/8") Dia.: 0.6 mm (1/32") Gauge: 23 Ga
Magazine Capacity	120
Dimensions (L x W x H)	257 x 79 x 226 mm (10-1/8" x 3-1/8" x 8-7/8")
Net weight	2.0 - 2.3 kg (4.4 - 5.1 lbs)

18V



Nose Adapter, Safety Goggles, Belt Clip, Hex Wrench, Battery, Fast Charger,  
Z: Battery and Charger are sold separately



**Pin Nail**  
(mm)      **0.6**      **A**      **0.6**

Materials	Steel			
<b>Length (A)</b>	18 mm	25mm	30mm	35mm
<b>Part No.</b>	F-00013	F-00026	F-01819	F-00055
<b>Type</b>	P18	P25	P30	P35
<b>Pcs/series</b>	100pcs			
<b>Pcs/pack</b>	100 x 30pcs			

**PT354DZ Cordless Pin Nailer**

12Vmax CXT Li-Ion Cordless 23 Ga 35 mm (1-3/8") Pin Nailer

**Li-ion** Ah 5.0 | 4.0 | 2.0 | 1.5



<b>Capacity</b>	Length: 15, 18, 25, 30, 35 mm (5/8", 11/16", 1-3/16", 1-3/8") Dia.: 0.6 mm (1/32") Gauge: 23 Ga
<b>Magazine Capacity</b>	120
<b>Dimensions (L x W x H)</b>	231x66x226 mm (9-1/8"x2-5/8"x8-7/8")
<b>Net weight</b>	1.8 - 2.0 kg (4.0 - 4.4 lbs.)

12Vmax

Nose Adapter, Safety Goggles, Belt Clip, Hex Wrench, Battery, Charger, DZ: Battery and Charger are sold separately

**FN001GD101(RDK) / GZ Cordless Brad Nailer**

40Vmax XGT BL Cordless 18 Ga 40 mm (1-5/8") Brad Nailer

**Li-ion** Ah 5.0 | 4.0 | 2.5 | 2.0



<b>Capacity</b>	Length: 15 - 40 mm (5/8" - 1-5/8") Gauge: 18 Ga
<b>Magazine Capacity</b>	100
<b>Shot q'ty on a single full battery charge</b>	w/ BL4025: 4,000
<b>Dimensions (L x W x H)</b>	w/ BL4025: 265 x 83 x 244 mm (10-3/8 x 3-1/4 x 9-5/8") w/ BL4040: 271 x 100 x 244 mm (10-5/8 x 3-15/16 x 9-5/8")
<b>Net weight</b>	2.6 - 2.9 kg (5.7 - 6.4 lbs.)

FN001GD101   
FN001GZ

40Vmax

Safety Goggles, Nose Adapter, Hex Wrench, Belt Clip, Battery, Charger, Z: Battery and Charger are sold separately

**DFN350ZJ Cordless Brad Nailer**

18V LXT Li-Ion Cordless 18 Ga 35 mm (1-3/8") Brad Nailer

**Li-ion** Ah 6.0 | 5.0 | 3.0 | 1.5



<b>Capacity</b>	Length: 15 - 35 mm (5/8" - 1-3/8") Gauge: 18 Ga
<b>Magazine Capacity</b>	110
<b>Dimensions (L x W x H)</b>	w/ BL1815N / BL1820B: 240x79x228 mm (9-1/2"x3-1/8"x9") w/ BL1830B / BL1840B / BL1850B / BL1860B: 257x79x228 mm (10-1/8"x3-1/8"x9")
<b>Net weight</b>	2.1 - 2.4 kg (4.6 - 5.3 lbs.)

18V

Safety Goggles, Nose Adapter, Hex Wrench, Belt Clip, Battery, Charger, Z: Battery and Charger are sold separately

**AF301 Pneumatic Nailer**

Application: Decoration, Picture Frame, Furniture, Shoe-Making, Drawer Assembly



<b>Capacity -</b>	<b>Length</b> 10-30mm (13/32" - 1-3/16")
<b>Width</b> 1.25 mm (0.05")	
<b>Wire</b> 1.05 mm (0.041")	
<b>Gauge</b> 18 Ga	
<b>Tank Max Pressure</b> 0.39-0.69 MPa (60-100 PSI)	
<b>Net Weight</b> 1.3 kg (2.86 lbs)	

With Safety Pin Preventing Accident Operation, Oil, Hex Wrench

**AF506 50mm (2") Pneumatic Brad Nailer**

16 GA Pneumatic Finish Nailer, Air Duster



<b>Capacity -</b>	<b>Length</b> 15 - 50 mm (5/8" - 2")
<b>Gauge</b> 18 Ga	
<b>Operating Pressure</b> 0.49 - 0.83 MPa (70 - 120 PSI)	
<b>Magazine Capacity</b> 100	
<b>Dimensions (L x W x H)</b> 250x70x256 mm (9-7/8"x2-3/4"x10-1/8")	
<b>Net Weight</b> 1.3 kg (2.9 lbs.)	

Safety Goggles, Oil supply, Nose Adapter, Hook

**ST002GZ Cordless Stapler** **New**

40Vmax XGT Cordless 10 mm J Wire Stapler

**Li-ion** Ah 8.0 | 5.0 | 4.0 | 2.5 | 2.0



<b>Staple</b>	<b>Width:</b> 10 mm <b>Length:</b> 13 - 25 mm (1/2" - 1") <b>Size:</b> 1.2 x 0.6 mm
<b>Magazine capacity</b>	100
<b>Shot q'ty on a single full battery charge</b>	w/ BL4025: 6,000
<b>Dimensions (L x W x H)</b>	w/ BL4025: 269 x 86 x 216 mm (10-5/8"x3-3/8"x8-1/2")
<b>Net weight</b>	2.5 - 3.7 kg (5.7 - 8.2 lbs.)

40Vmax

Nose adapter, Belt clip, Battery, Charger, Z: Battery and Charger are sold separately





**DST121ZK Cordless Stapler**

18V LXT Li-Ion Cordless 10 mm J Wire Stapler

Li-ion Ah 6.0 5.0 3.0 1.5



<b>Staple</b>	Width: 10 mm Length: 13 - 25 mm (1/2" - 1") Size: 1.2 x 0.6 mm
<b>Magazine capacity</b>	100
<b>Shot q'ty on a single full battery charge</b>	w/BL1860B: 4,800
<b>Dimensions (L x W x H)</b>	w/BL1815N: 244x79x216 mm (9-5/8"x3-1/8"x8-1/2") w/BL1830B / BL1850B / BL1860B: 260x79x216 mm (10-1/4"x3-1/8"x8-1/2")
<b>Net weight</b>	2.2 - 2.5 kg (4.9 - 5.5 lbs.)

18V **LXT XPT**

Safety Goggles, Nose Adapter, Belt Clip, Battery, Charger, Z: Battery and Charger are sold separately

**DST221Z Cordless Stapler**

Machined aluminum magazine ensures smooth staple loading and feeding

Li-ion Ah 6.0 5.0 3.0 1.5



<b>Staple</b>	Width: 10 mm (3/8") Length: 10, 13, 16, 19, 22 mm (3/8"; 1/2"; 5/8"; 3/4"; 7/8") Gauge: 0.6 x 1.2 mm (1/32" x 1/16")
<b>Magazine Capacity</b>	98
<b>Sound Power Level</b>	93 dB(A)
<b>Dimensions (L x W x H)</b>	251x91x212 mm (9-7/8"x3-5/8"x8-3/8")
<b>Net weight</b>	2.1 - 2.4 kg (4.7 - 5.3 lbs)

18V **LXT** 5

Safety Goggles, Z: Battery and Charger are sold separately

**DST421ZK Cordless Stapler**

18V LXT Li-Ion Cordless 4 mm J Wire Stapler

Li-ion Ah 6.0 5.0 3.0 1.5



<b>Staple</b>	Width: 4 mm Length: 13 - 25 mm (1/2" - 1") Size: 1.2 x 0.6 mm
<b>Magazine capacity</b>	100
<b>Shot q'ty on a single full battery charge</b>	w/BL1860B: 4,800
<b>Dimensions (L x W x H)</b>	w/BL1815N: 244x79x216 mm (9-5/8"x3-1/8"x8-1/2") w/BL1830B / BL1850B / BL1860B: 260x79x216 mm (10-1/4"x3-1/8"x8-1/2")
<b>Net weight</b>	2.2 - 2.5 kg (4.9 - 5.5 lbs.)

18V **LXT XPT**

Safety Goggles, Nose Adapter, Belt Clip, Battery, Charger, Z: Battery and Charger are sold separately

**AT1022AZ Pneumatic Stapler**

Application: Cabinet Making, Case back Assembly, Drawer Assembly, Furniture



<b>Capacity - Length Gauge</b>	10 - 22 mm (13/32" - 7/8") 18 Ga
<b>Magazine Capacity</b>	100
<b>Operating Pressure</b>	0.45 MPa (65 PSI)
<b>Dimensions (L x W x H)</b>	250x55x180 mm (9-3/4"x2-1/4"x7")
<b>Net Weight</b>	1.3 kg (2.86 lbs)

10

With Safety Pin Preventing Accident Operation, Oil, Hex Wrench

**SPECIALITY TOOLS**

**PRODUCTS**



**DRV250Z Cordless Rivet Gun**

18V LXT BL Brushless Cordless Rivet Gun

Li-ion Ah 6.0 5.0 3.0 1.5



<b>Max pulling force</b>	20 kN
<b>Length of Stroke</b>	30 mm (1-3/16")
<b>Center height</b>	26 mm (1")
<b>Sound Pressure Level</b>	74 dB(A)
<b>Vibration Level</b>	2.5 m/s <sup>2</sup> or less
<b>Dimensions (L x W x H)</b>	w/BL1830B / BL1850B / BL1860B: 320x80x287 mm (12-5/8"x3-1/8"x11-1/4")
<b>Net weight</b>	2.1 - 2.4 kg (4.6 - 5.3 lbs.)

18V **LXT BL XPT** 1

Hook, Grease, Accessory Set, Battery, Charger, Z: Battery and Charger are sold separately

**DGP180Z Cordless Grease Gun**

Powerful motor delivers up to 69 MPa (10,000 PSI) of max pressure

Li-ion Ah 6.0 5.0 3.0 1.5



<b>Max Operating Pressure</b>	69 MPa (10,000 PSI)
<b>Flow Rate</b>	Slow Speed Mode: 145 mL/min (5.0 oz/min) Auto Speed Change Mode: 290 mL/min (10.0 oz/min)
<b>Grease Capacity w/ Barrel A</b>	Cartridge / Bulk: 410 / 455 g
<b>Grease Capacity w/ Barrel B</b>	Cartridge / Bulk: 450 / 570 g
<b>Hose Length</b>	120 cm (47-1/4")
<b>Dimensions (L x W x H)</b>	w/ Barrel A: 411x114x245 mm (16-1/4"x4-1/2"x9-5/8") w/ Barrel B: 449x114x245 mm (17-3/4"x4-1/2"x9-5/8")
<b>Net weight</b>	4.8 - 6.1 kg (10.6 - 13.4 lbs.)

18V **LXT**

Shoulder Strap, Battery, Charger, Z: Battery and Charger are sold separately

**DVP181ZK** Cordless Vacuum Pump

Long run time of 50 minutes with a fully charged BL1850B (5.0Ah)

Li-ion Ah 6.0 | 5.0 | 3.0 | 1.5



Flow rate	113 L/min
Ultimate vacuum	3 Pa
Motor speed	3,200 min <sup>-1</sup>
Oil Tank Capacity	300 mL
Inlet port	5/16" / 3/8"
Dimensions (L x W x H)	383 x 193 x 210 mm (15-1/8" x 7-5/8" x 8-1/4")
Net weight	8.1 - 8.2 kg (17.9 - 18.1 lbs.)

18V

LXT

1

Vacuum Pump Oil, Adapter, Battery, Charger, Z: Battery and Charger are sold separately

**DVP180Z** Cordless Vacuum Pump

Long run time of 50 minutes with a fully charged BL1850B (5.0Ah)

Li-ion Ah 6.0 | 5.0 | 3.0 | 1.5



Flow rate	50 L/min
Ultimate vacuum	20 Pa (150 microns)
Motor speed	3,840 min <sup>-1</sup>
Oil Tank Capacity	115 mL
Inlet port	5/16"
Dimensions (L x W x H)	265x93x175 mm (10-3/8"x3-5/8"x6-7/8")
Net weight	3.5 kg

18V

LXT

2

Pump oil, Adapter, Battery, Fast Charger, Z: Battery and Charger are sold separately

**AC001GZ** Cordless Air Compressor

New

Developed mainly for interior nailing applications e.g. finish nailing with 18 Ga nail

Li-ion Ah 8.0 | 5.0 | 4.0 | 2.5 | 2.0



Tank	7.6 L (2 gal)
Cut-In Pressure	0.72 MPa (105 PSI)
Cut-Out Pressure	0.93 MPa (135 PSI)
Number of Outlets	1
Performance	34.0 L/min
Noise Level	68 dB(A)
Dimensions (L x W x H)	302x434x382 mm (11-7/8" x 17-1/8" x 15")
Net weight	11.6 - 12.8 kg (25.6 - 28.2 lbs.)

40Vmax

LXT BL

Z: Battery and Charger are sold separately

**DTR181Z** Cordless Rebar Tying Tool

18V LXT BL Brushless Cordless Rebar Tying Tool

Li-ion Ah 6.0 | 5.0 | 3.0 | 1.5



Tie Wire	ø0.8 mm
Applicable Rebars	D16 x D16 - [D13 x 2] x [D16 x 2] w/ BL1830B / BL1850B / BL1860B:
Dimensions (L x W x H)	317 x 93 x 318 mm (12-1/2 x 3-5/8 x 12-1/2")
Net weight	2.4 - 2.7 kg (5.3 - 6.0 lbs.)

18V

LXT BL XPT

Nylon brush, Hex Wrench, Hook, Z: Battery and Charger are sold separately

**DTC100ZK (Close Type)**

Cordless Cable Cutter

New

Closed type for precision cutting

Li-ion Ah 6.0 | 5.0 | 3.0 | 1.5



Max. cutting diameter	50 mm (2")
Max cable cutting capacity	1600V-CV: 500mm <sup>2</sup> single-core (38mm (1-1/2)), 6600V-CV: 500mm <sup>2</sup> single-core (45mm (1-3/4)), 600V-IV: 500mm <sup>2</sup> single-core (35mm (1-3/8)), 600V-VVR: 150mm <sup>2</sup> triple-core (47mm (1-7/8))
Dimensions (L x W x H)	w/BL1830B / BL1850B / BL1860B: 116 x 197 x 363 mm (4-9/16 x 7-3/4 x 14-1/4")
Net weight	2.9 kg (6.4 lbs.)

18V

LED LXT

Blade, Z: Battery and Charger are sold separately

**DTC101ZK (Open Type)**

Cordless Cable Cutter

New

Open type for easy cutting of cable at desired position

Li-ion Ah 6.0 | 5.0 | 3.0 | 1.5



Max. cutting diameter	50 mm (2")
Max cable cutting capacity	600V-CV: 500mm <sup>2</sup> single-core (38mm (1-1/2)), 6600V-CV: 500mm <sup>2</sup> single-core (45mm (1-3/4)), 600V-IV: 500mm <sup>2</sup> single-core (35mm (1-3/8)), 600V-VVR: 150mm <sup>2</sup> triple-core (47mm (1-7/8))
Dimensions (L x W x H)	w/BL1830B / BL1850B / BL1860B: 116 x 190 x 430 mm (4-9/16 x 7-1/2 x 17")
Net weight	3.6 kg (7.9 lbs.)

18V

LED LXT

Blade, Z: Battery and Charger are sold separately

**DTM52RTJX2 / Z** Cordless Multi Tool

Tool-less accessory clamp for quick installation and replacement

Li-ion Ah 6.0 | 5.0 | 3.0 | 1.5



Oscillations Per Minute (OPM)	10,000 - 20,000
Oscillation Angle	Left / Right / Total: 1.8° / 1.8° / 3.6°
Dimensions (L x W x H)	w/BL1830B / BL1850B / BL1860B: 322 x 95 x 126 mm (12-5/8 x 3-3/4 x 5")
Net weight	1.7 - 2.0 kg (3.7 - 4.4 lbs.)

18V

LXT BL XPT

LXT BL AVT XPT

Oscillating Multi Tool Accessories, Battery, Charger, Z: Battery and Charger are sold separately



# Extra versatility

DTM52 Compatible with STARLOCK MAX accessories



STARLOCK MAX



Cutting plasterboards



Deep plunge cutting



Wood flush cutting



Pocket cutting



Cutting PVC, FRP pipes



Routing joints on wall tiles



Removal of window frame



Door opening work



Cutting metals



Copper pipe flush cutting



Cutting window putty, silicone



Sanding and polishing

## DTM51Z Cordless Multi Tool

Tool-less accessory clamp for quick installation and replacement

Li-ion Ah 6.0 | 5.0 | 3.0 | 1.5



Oscillations Per Minute (OPM)	6,000 - 20,000
Oscillation Angle	Left / Right / Total: 1.6° / 1.6° / 3.2°
Sound Power Level	Plunge Saw Blade: 92 dB(A) Scraping: 91 dB(A)
Dimensions (L x W x H)	340x80x122 mm (13-3/8"x3-1/8"x4-13/16")
Net weight	2.0 - 2.4 kg (4.4 - 5.3 lbs)

18V



Fast Charger, Battery Cartridge, Hex Wrench, Z: Battery and Charger are sold separately

## TM3010CX6 Multi Tool

320 W Toolless Multi Tool

459 mm



Continuous rating input	320W
Strokes Per Minute (SPM)	6,000 - 20,000
Dimensions (L x W x H)	283 x 68 x 87 mm (11-1/8 x 2-1/16 x 3-7/16")
Net weight	1.6 - 1.7 kg (3.7 - 3.9 lbs.)
Power supply cord	2.5 m (8.2 ft)



Oscillating Multi Tool Accessories

## CP100DSA / DZ Cordless Multi Cutter

12Vmax CXT Li-Ion Cordless Multi Cutter

Li-ion Ah 5.0 | 4.0 | 2.0 | 1.5



Max Cutting Capacity	6 mm (1/4")
No Load Speed (RPM)	300
Vibration Level	Cutting Cardboard: 2.5 m/s <sup>2</sup> or less
Dimensions (L x W x H)	272x66x120 mm (10-3/4"x2-5/8"x4-3/4")
Net Weight	0.72 - 0.88 kg (1.6 - 1.9 lbs)

CP100DSA CP100DZ

12Vmax



Blade, Battery, Charger, DZ: Battery and Charger are sold separately

## DCG180ZB Cordless Caulking Gun

18V LXT Li-Ion Cordless Caulking Gun

Li-ion Ah 6.0 | 5.0 | 3.0 | 1.5



Max Dispensing Force	5,000 N (1,100 lbs)
No load speed	0 - 28 mm/sec. (0 - 66 in./min.)
Holder Size	300, 600, 800 mL
Dimensions (L x W x H)	404x108x281 mm (15-7/8"x4-1/4"x11-1/8")
Net weight	2.1 - 3.0 kg (4.7 - 6.6 lbs)

18V



Fast Charger, Battery Cartridge, Holder, Holder Joint, Piston, Rubber Ring, Nozzle, Z: Battery and Charger are sold separately

## CG100DZA Cordless Caulking Gun

12Vmax CXT Li-Ion Cordless Caulking Gun

Li-ion Ah 5.0 | 4.0 | 2.0 | 1.5



Max Dispensing Force	5,000 N (1,100 lbs)
No load speed	0 - 28 mm/sec. (0 - 66 in./min.)
Holder Size	300, 600, 800 mL
Dimensions (L x W x H)	404x108x259 mm (15-7/8"x4-1/4"x10-1/4")
Net weight	1.9 - 2.6 kg (4.2 - 5.8 lbs)

12Vmax



Holder, Holder Joint, Piston, Rubber Ring, Nozzle, Battery, Charger, DZ: Battery and Charger are sold separately

## MP001GZ Cordless Inflator

3 Inflation modes (High speed, Low speed or Ball modes)

Li-ion Ah 8.0 | 5.0 | 4.0 | 2.5 | 2.0



Air Discharge Amount	200 kPa: 24 L/min 700 kPa: 12 L/min
Max Air Pressure	1,110 kPa (161 PSI) [11.1 bar]
Hose Length	65 cm (25-1/2")
Sound Pressure	71 dB(A)
Dimensions (L x W x H)	w/BL4020/BL4025: 320 x 108 x 231 mm (12-5/8 x 4-1/4 x 9-1/8"), w/BL4040: 329 x 108 x 231 mm (13 x 4-1/4 x 9-1/8"), w/BL4050F: 351 x 108 x 231 mm (13-3/4 x 4-1/4 x 9-1/8")
Net Weight	2.9 - 3.5 kg (6.4 - 7.7 lbs.)

40Vmax



British Adapter, French Adapter, Ball Adapter, Swim Ring Adapter, Battery, Charger, Z: Battery and Charger are sold separately

**DMP180Z** Cordless Inflator

18V max LXT Li-Ion Cordless Inflator

Li-ion Ah 6.0 | 5.0 | 3.0 | 1.5



Max Air Pressure 830 kPa (121 PSI)  
 Air Discharge amount 200 kPa: 10 L/min  
 Dimensions (L x W x H) w/ BL1830B / BL1850B / BL1860B: 270x76x175 mm (10-5/8"x3"x6-7/8")  
 Net weight 1.5 - 1.8 kg (3.3 - 4.0 lbs.)

18V

British Adapter, French Adapter, Ball Adapter, Swim Ring Adapter, Battery, Charger, Z: Battery and Charger are sold separately

**MP100DZ** Cordless Inflator

12Vmax CXT Li-Ion Cordless Inflator

Li-ion Ah 5.0 | 4.0 | 2.0 | 1.5



Max Air Pressure 830 kPa  
 Air Discharge amount 200kPa: 10 L/min  
 Dimensions (L x W x H) w/ BL1016/BL1021B: 235x74x173 mm (9-1/4"x2-15/16"x6-13/16") w/ BL1041B: 255x74x173 mm (10"x2-15/16"x6-13/16")  
 Net weight 1.2 - 1.3 kg (2.6 - 3.0 lbs.)

12Vmax

Valve adapter, Ball adapter, Floating tube adapter, DZ: Battery and Charger are sold separately

# MEASURING/ LEVELING

## PRODUCTS



**SK10GDZ** Rechargeable Green Multi Line Laser

Bright green laser for increased visibility

Li-ion Ah 5.0 | 4.0 | 2.0 | 1.5



Leveling Accuracy  $\pm 1$  mm / 10 m  
 Self-Leveling Range  $\pm 4^\circ$   
 Laser Fan Angle Horizontal:  $110^\circ$   
 Vertical:  $130^\circ$   
 Laser line selection 4V1H / 2V1H / 1V1H  
 Laser Type Laser class 2: 515 nm  
 Operating Temperature  $-10 - 40^\circ\text{C}$   
 Protection class IP54  
 Operating Time BL1016: 12 hours  
 Dimensions w/ BL1016/BL1021B: (L x W x H) 98x223 mm  
 Net Weight 1.4 - 1.6 kg (3.1 - 3.5 lbs)

12Vmax

Laser detector, Laser Receiver Vise, Laser Viewing Glass, Shoulder Strap, Storage Case, Battery, DZ: Battery and Charger are sold separately

## Green Laser Series



Powered by the following 12V max slide CXT Li-ion batteries

**SK40GD / SK10GD**

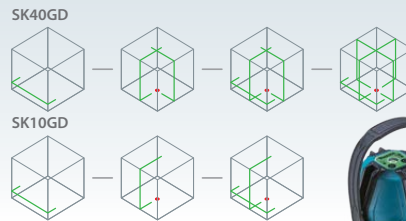

Continuous runtime  
SK40GD / SK10GD

6 / 9 / 12 h  
BL1016  
Normal

12 / 16 / 20 h  
BL1016  
Eco mode

Leveling accuracy  $\pm 1$  mm / 10 m



**SK40GDZ** Rechargeable Green Multi Line Laser

Bright green laser for increased visibility

Li-ion Ah 5.0 | 4.0 | 2.0 | 1.5



Leveling Accuracy  $\pm 1$  mm / 10 m  
 Self-Leveling Range  $\pm 4^\circ$   
 Laser Fan Angle Horizontal:  $110^\circ$   
 Vertical:  $130^\circ$   
 Laser line selection 4V1H / 2V1H / 1V1H  
 Laser Type Laser class 2: 515 nm  
 Operating Temperature  $-10 - 40^\circ\text{C}$   
 Protection class IP54  
 Operating Time BL1016: 6 hours  
 Dimensions w/ BL1016/BL1021B: (L x W x H) 98x223 mm  
 Net Weight 1.4 - 1.6 kg (3.1 - 3.5 lbs)

12Vmax

Laser detector, Laser Receiver Vise, Laser Viewing Glass, Shoulder Strap, Storage Case, Battery, DZ: Battery and Charger are sold separately

**SK700GD** Rechargeable Green / Red Multi Line Laser

3 x full 360-degree lines for quick and easy setup

Li-ion Ah 5.0 | 4.0 | 2.0 | 1.5



Leveling accuracy  $\pm 2$  mm / 10 m  
 Self-leveling rang  $\pm 4^\circ$   
 Laser type SK700GD: Laser class 2: 510 - 530 nm  
 SK700D: Laser class 2: 630 - 645 nm  
 Operating Temperature  $-10 - 50^\circ\text{C}$   
 Protection class IP54  
 Dimensions (L x W x H) w/ BL1016/BL1021B: 149 x 104 x 153 mm (5-7/8 x 4-1/8 x 6") w/ BL1041B: 168 x 104 x 153 mm (6-5/8 x 4-1/8 x 6")  
 Net weight 0.99 - 1.2 kg (2.2 - 2.7 lbs.)

12Vmax

Target Plate, Adapter, Soft Bag, DZ: Battery and Charger are sold separately



**SK105GDZ** Rechargeable Green / Red Cross Line Laser

High brightness green laser for increased visibility at bright site

Li-ion Ah 5.0 | 4.0 | 2.0 | 1.5



Measuring range	Up to: 35 m
Measuring range w/detector	Up to: 80 m
Leveling accuracy	±3 mm / 10 m
Self-leveling range	±4°
Number of laser lines	2
Laser type	Laser class 2: 525 nm
Operating temperature	-10 - 50 °C
Operating Time (Approx. Hrs)	7 - 20
Dimensions (L x W x H)	w/ BL1016/BL1021B: 1138x64x102 mm w/ BL1041B: 157x64x102 mm
Net weight	0.67 - 0.84 kg

12Vmax



10

Soft bag, Adapter, Target Plate, DZ: Battery and Charger are sold separately

**LD030P** 30m Laser Distance Measure

Measuring accuracy and productivity



Measuring Range	0.2-30m
Operating Temperature	0 - 40°C
Storage Temperature	-25 - 70°C
Typical Measuring Tolerance	±2.0mm / 10m
Max Measuring Tolerance	±3.0mm / 10m
Diameter Of Laser Point	6mm / 10m
Laser Type	Laser class 2: 635nm
Dimensions (H x D x W)	117x53x25mm (4.5"x2.14"x1")
Net Weight	0.1kg (0.22lbs)

20

Alkaline Battery (2), Carrying Strap

**LD050P** 50m Laser Distance Measure

Measuring accuracy and productivity



Measuring Range	0.05-50m
Power Supply	Cell battery: AAA 1.5V x 2pcs
Net Weight	0.1kg (0.22lbs)

10

Alkaline Battery (2), Carrying Strap Front Cuffs 24, Poly Bag Set

**LD080P** 80m Laser Distance Measure

Measuring accuracy and productivity



Measuring Range	0.05-80m
Power Supply	Cell battery: AAA 1.5V x 2pcs
Net Weight	0.14kg (0.31lbs)

10

Alkaline Battery (2), Carrying Strap

**COMFORT/ LIFESTYLE**

**PRODUCTS**



**CF003GZ** 450mm (17-3/4") Cordless Fan

**New**

40Vmax XGT / 18V LXT Li-Ion Cordless 450 mm (17-3/4") Fan

Li-ion Ah 8.0 | 5.0 | 4.0 | 2.5 | 2.0



Air velocity	96-300 m/min
Air flow	38-120 m³/min
Fan diameter	450 mm (17-3/4")
Fan head angle adjustment	Up: 90° / Down: 45° Left: 90° / Right: 90°
Automatic oscillation	Left: 60, 90, 120° Right: 60, 90, 120°
Continuous use (min.) w/o oscillation	w/ BL4040: 115 / w/ BL4080F: 230 / w/ BL1860B: 90
Dimensions (L x W x H)	w/o Battery: 312 x 633 x 770 mm (12-1/4 x 25 x 30-1/4") w/o Battery: 7.9 kg (17.4 lbs.)
Net weight	

40Vmax

18V



1

AC Adaptor, Z: Battery and Charger are sold separately

**CF002GZ** 330mm (13") Cordless Fan

Increased max air velocity 240 m/min

Li-ion Ah 8.0 | 5.0 | 4.0 | 2.5 | 2.0



Continuous Use (min.) w/o oscillation	w/ BL4040: Low / Mid / High: 1,020 / 640 / 320
Continuous Use (min.) w/o oscillation	w/ BL4040: Low / Mid / High: 970 / 610 / 305
Max Air Velocity	High / Mid / Low: 240 / 170 / 120 m/min
Air Flow	High / Mid / Low: 21 / 15 / 10 m³/min
Noise level	52 dB(A)
Fan Diameter	330 mm (13")
Dimensions (L x W x H)	w/ BL4040: 277 x 439 x 602 mm
Net weight	3.8 - 5.1 kg (8.4 - 11.2 lbs.)

40Vmax



1

AC Adaptor, Z: Battery and Charger are sold separately



450 mm fan diameter

Max air flow volume  
**120**  
m<sup>3</sup> / min

Max air speed\*  
**300**  
m / min  
\*Measured at 1.0 m away from the appliance

photo: CF003G

**Compatible with**

- 40Vmax XGT Li-Ion battery
- 18V LXT Li-Ion battery
- AC (through AC adapter)

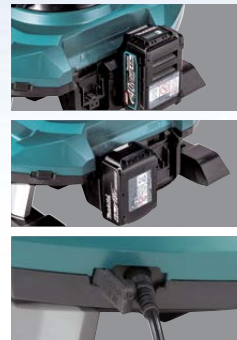

**Manual angle adjustment of fan head**



90° up/45° down with a locking knob

**Automatic oscillation**



Automatic oscillation angle adjustment: 60°, 90°, 120° left/right

**Three Off timer settings**

1 hour, 2 hours, 4 hours

**CF001GZ 235 mm (9-1/4") Cordless Fan**

40Vmax XGT Automatic Swing Fan

Li-ion Ah 5.0 | 4.0 | 2.5 | 2.0



40Vmax XGT 3

AC Adaptor, Z: Battery and Charger are sold separately

Continuous Use (min.) w/o oscillation	w/ BL4040 Low / Mid / High: 1,160 / 880 / 660 w/ BL4025 Low / Mid / High: 730 / 550 / 410
Continuous Use (min.) w/ oscillation	w/ BL4040 Low / Mid / High: 1,055 / 800 / 600 w/ BL4025 Low / Mid / High: 665 / 500 / 370
Max Air Velocity	High / Med / Low: 190 / 150 / 120 m/min
Air Flow	High / Med / Low: 8.2 / 6.5 / 5.2 m <sup>3</sup> /min 143x333x463 mm (5-5/8"x13"x18-1/4")
Dimensions (L x W x H)	
Net weight	2.0 - 3.0 kg (4.4 - 6.6 lbs.)

**DCF301Z 330mm (13") Cordless Fan**

Increased max air velocity 240 m/min

Li-ion Ah 6.0 | 5.0 | 3.0 | 1.5



18V 14.4V XGT LXT 1

AC Adaptor, Z: Battery and Charger are sold separately

Continuous Use (min.) w/o oscillation	w/ BL1860B: Low / Mid / High: 850 / 430 / 215
Continuous Use (min.) w/ oscillation	w/ BL1860B: Low / Mid / High: 815 / 415 / 210
Max Air Velocity	High / Mid / Low: 240 / 170 / 120 m/min
Air Flow	High / Mid / Low: 21 / 15 / 10 m <sup>3</sup> /min
Noise level	52 dB(A)
Fan Diameter	330 mm (13")
Dimensions (L x W x H)	w/ BL1860B: 269 x 439 x 602 mm
Net weight	3.8 - 4.5 kg (8.4 - 9.9 lbs.)

**DCF203Z 235 mm (9-1/4") Cordless Fan**

Automatic Swing Fan

Li-ion Ah 6.0 | 5.0 | 3.0 | 1.5



18V 14.4V XGT LXT 3

Z: Battery and Charger are sold separately

Max Continuous Use (min.)	w/ BL1860B: Low / Medium / High: 1,010 / 650 / 410
Max Air Velocity	High / Med / Low: 190 / 150 / 120 m/min
Air Flow	High / Med / Low: 8.2 / 6.5 / 5.2 m <sup>3</sup> /min 140x333x447 mm (5-1/2"x13"x16-1/2")
Dimensions (L x W x H)	
Net weight	1.9 - 2.6 kg (4.2 - 5.6 lbs.)

**DCF102ZX1 180 mm (7-1/8") Cordless Fan**

Automatic Swing Fan

Li-ion Ah 6.0 | 5.0 | 3.0 | 1.5



18V XGT LXT 4

Z: Battery and Charger are sold separately

Max Continuous Use (min.)	w/ BL1860B: Low / Medium / High: 1270 / 705 / 575
Dimensions (L x W x H)	185x272x284 mm (7-1/4"x10-3/10"x11-1/8")
Net weight	1.3 - 2.0 kg (2.9 - 4.4 lbs.)

**CW002GZ Cordless Cooler & Warmer Box**

Large 50 L capacity

Li-ion Ah 8.0 | 5.0 | 4.0 | 2.5 | 2.0



40Vmax 18V XGT LXT 3

Cigar Socket Cable, Z: Battery and Charger are sold separately

Capacity	50L (13.2 gal)
Cooling Capacity	-18/-15/-10/-5/0/5/10°C (0/5/15/25/30/40/50°F)
Warming System	30/35/40/45/50/55/60°C (85/95/105/115/120/130/140°F)
Run Time	w/ BLBL4040, -18/5/60°C: 8 / 19.5 / 4.5
Cord Length	AC Adapter / Cigar Socket Cable: 2 / 2.5 m (6.5 / 8.2 ft)
Storage dimensions (L x W x H)	500 x 320 x 320 mm (19-3/4 x 12-5/8 x 12-5/8")
Dimensions (L x W x H)	867 x 465 x 476 mm (34-1/8 x 18-1/4 x 18-3/4")
Net weight	25.6 - 29.0 kg (56.4 - 63.9 lbs.)

**CW004GZ Cordless Cooler & Warmer Box**

A combination of XGT battery and LXT battery is also accepted

Li-ion Ah 8.0 | 5.0 | 4.0 | 2.5 | 2.0



40Vmax 18V XGT LXT 3

Shoulder belt, AC adaptor, Cigar socket cable, Inner tray, Inner basket, Z: Battery and Charger are sold separately

Capacity	29L (7.7 gal)
Cooling System	-18°C (0°F)
Warming System	60°C (140°F)
Temperature setting	17 settings: -18/-15/-10/-5/0/5/10/15/20/25/30/35/40/45/50/55/60°C
Run Time	w/ BL4050F x2, -18/5/60°C: 12.5/30.0/11.5
Cord Length	AC Adapter / Cigar Socket Cable: 2.2 / 2.5 m (7.2 / 8.2 ft)
Storage Dimensions	343 x 240 x 338 mm
Dimensions (L x W x H)	676 x 345 x 471 mm (26-5/8 x 13-5/8 x 18-1/2")
Net weight	7.5 - 20.9 kg (38.6 - 46.1 lbs.)

New





Top cover that can be opened from both sides

**Work amount on full battery charge**  
with two BL4050F batteries / When used as one room

-18°C [0°F] about <b>12.5 h</b>	5°C [40°F] about <b>30 h</b>	60°C [140°F] about <b>11.5 h</b>
---------------------------------------	------------------------------------	--

**17 inside temperature settings**



**29 L (7.7gal)**

**Dual room mode is available by using the partition plate.**



photo: CW004G

**CW001GZ Cordless Cooler & Warmer Box**

Powered by 4 sources: 40Vmax / 18V / 12V/24V DC (cigar socket) / AC

Li-ion Ah 8.0 | 5.0 | 4.0 | 2.5 | 2.0



Capacity	20L (5.3gal)
Cooling System	Compressor type
Cooling Capacity	-18/-15/-10/-5/0/5/10°C
Warming System	Heater
Warming Capacity	30/35/40/45/50/55/60°C
Run Time	w/BL4050F X2, -18°C/5°C/60°C: 10h/28h/8.5h
Cord Length	AC Adapter / Cigar Socket Cable: 2/2.5m (6.5/8.2ft)
Dimensions (L x W x H)	663x341x372mm (26-1/8x13-3/8x14-5/8")
Net weight	13.5-16.1kg (29.8-35.5 lbs.)

40Vmax 18V XGT LXT 12V 24V

Shoulder Belt, Cigar Socket Cable, Z: Battery and Charger are sold separately

**CW003GZ Cordless Cooler & Warmer Box**

Compact design, 7 L capacity

Li-ion Ah 8.0 | 5.0 | 4.0 | 2.5 | 2.0



Capacity	7L (1.8gal)
Cooling System	Compressor type
Cooling Capacity	-18/-15/-10/-5/0/5/10°C
Warming System	Heater
Warming Capacity	30/35/40/45/50/55/60°C
Run Time	w/BLBL4040, -18/5/60°C: 5.5/13.5/5.5
Cord Length	AC Adapter / Cigar Socket Cable: 2/2.5m (6.5/8.2ft)
Dimensions (L x W x H)	456 x 245 x 308 mm (18 x 9.5/8 x 12-1/8")
Net weight	7.9-9.4kg (17.4-20.7 lbs.)

40Vmax 18V XGT LXT 12V 24V

Shoulder Belt, Cigar Socket Cable, Z: Battery and Charger are sold separately

**MW001GZ Cordless Microwave**

**New**

Excellent portability

Li-ion Ah 8.0 | 5.0 | 4.0 | 2.5 | 2.0



Useful cavity dimensions (W x D x H)	255 x 241 x 120 mm (10 x 9-1/2 x 4-3/4")
Cavity capacity	8 L
Microwave power	High / Low: 500 / 350 W
Operating frequency	2,450 MHz
Continuous run time on full battery charge (350 / 500 W)	w/BL4020 x2: 11 / 6 min., w/BL4025 x2: 14 / 8 min., w/BL4040 x2: 21 / 15 min., w/BL4050F x2: 30 / 22 min., w/BL4080F x2: 48 / 35 min., w/PDC1200: 113 / 84 min.
Dimensions (L x W x H)	w/o Battery: 318 x 343 x 338 mm (12-1/2 x 13-1/2 x 13-1/4")
Net weight	w/o Battery: 8.9 kg (19.6 lbs.)

40Vmax XGT

Z: Battery and Charger are sold separately

**Popular size food container can be heated.**



photo: MW001G

Cavity capacity  
**8 L**

**Control panel**

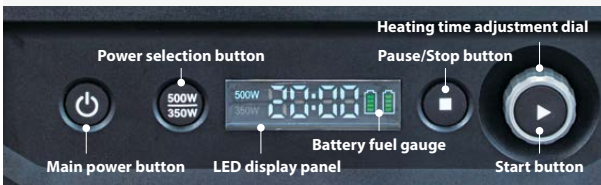

**Approx number of times an item can be heated**

With two fully charged BL4040 batteries

food container of chilled items  
**5 times**

mug of drink (200mL)  
**8 times**

**Continuous heating time on a full battery charge (approx)**

**500 w : 35 min\***

Battery: BL4080F x2

\* This is the total time of repeated maximum 8-minute continuous heating at 500W in temporary boost mode



1. Stops heating promptly and automatically when tilted.



2. Stops heating promptly and automatically when the door is opened during heating.



3. Reminder beep for items left in the cavity





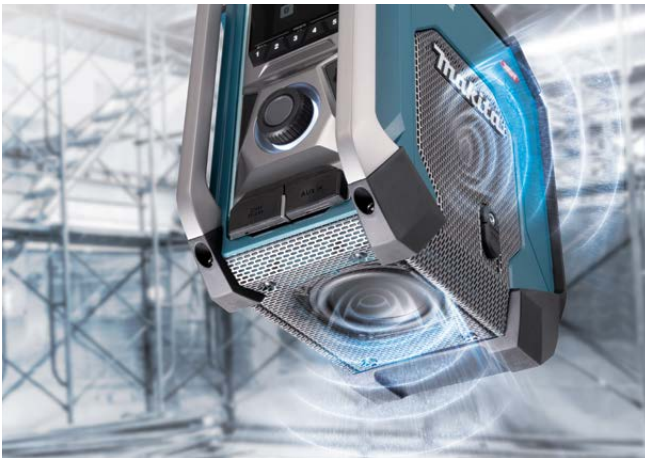

**MR006G Job Site Radio**

12Vmax-40Vmax CXT LXT XGT Li-Ion Cordless Bluetooth Job Site Radio

Li-ion Ah 8.0 5.0 4.0 2.5 2.0



Frequency Band	FM / AM: 87.5 - 108 MHz / 522 - 1,710 kHz
Speaker Size	Sides: Dia. 63.5 mm x2 Bottom: Dia. 101.6 mm
Max Output	40Vmax: 5 W x2 + 25 W / 18V: 5 W x2 + 25 W / 14.4V: 3 W x2 + 15 W / 12Vmax: 2 W x2 + 10 W
Bluetooth	Version: 5.0 Profile: A2DP / SCMS-T / AVRCP Supported Codec: SBC Max Transmission Range: 10 m (33 ft)
Dimensions (L x W x H)	w/ Handle in Retracted Position: 285 x 172 x 305 mm
Net weight	5.6 - 6.4 kg (12.3 - 14.1 lbs.)

Bluetooth

40Vmax 18V 14.4V 12Vmax 10.8V



AC Adaptor, AA Battery

**MR002G Job Site Radio**

12Vmax-40Vmax CXT LXT XGT Li-Ion Cordless Bluetooth Job Site Radio

Li-ion Ah 8.0 5.0 4.0 2.5 2.0



Frequency Band	FM / AM: 87.5 - 108 MHz / 522 - 1,710 kHz
Speaker Size	Woofer: Dia. 89 mm x2
Max Output	40Vmax: 3.5 W x2
Bluetooth	Version: 5.0 Profile: A2DP / SCMS-T Supported Codec: SBC Max Transmission Range (Optimum): 10 m (33 ft) w/ Handle in Upright Position: 280 x 171 x 434 mm (11 x 6-3/4 x 17-1/8")
Dimensions (L x W x H)	
Net weight	4.6 - 5.4 kg (10.1 - 11.9 lbs.)

Bluetooth

40Vmax 18V 14.4V 12Vmax 10.8V



AC Adaptor, AA Battery

**DMR108 Job Site Radio**

7.2V-18V CXT LXT Li-Ion Cordless Bluetooth Job Site Radio

Li-ion Ah 6.0 5.0 3.0 1.5



Frequency Band	FM / AM: 87.5 - 108 MHz / 522 - 1,710 kHz
Speaker Size	Woofer: Ø89 mm x2
Max Output	18V: 3.5 W x2 / 14.4V: 2.2 W x2 / 12Vmax: 1.2 W x2 / 7.2V: 0.5 W x2
Bluetooth	Version: 4.0 Profile: A2DP / SCMS-T Supported Codec: SBC Max Transmission Range: 10 m (33 ft)
Dimensions (L x W x H)	w/ Handle in Upright Position: 262 x 163 x 431 mm (10-3/8" x 6-3/8" x 17")
Net weight	4.4 kg (9.7 lbs.)

Bluetooth

18V 14.4V 12Vmax 10.8V 7.2V



AC Adaptor, AA Battery

**MR010G Cordless Radio with Lantern**

40Vmax XGT Cordless Bluetooth Radio with Lantern

Li-ion Ah 8.0 5.0 4.0 2.5 2.0



Frequency Band	FM: 87.5-108 MHz
Speaker Size	Ø57 mm
Illuminance (High/Low)*	Flashlight: 1,000/500, Lantern: Daylight white 145/72, Neutral white 140/70, Warm white 130/65
Luminous flux (High/Low)	Flashlight: 200/100, Lantern: Daylight white 310/155, Neutral white 300/150, Warm white 260/130
Bluetooth	Version: 5.0, Profile: A2DP, SCMS-T, AVRCP, Supported Codec: SBC, Max Transmission Range (Optimum): 10 m (33 ft) w/o Battery: 126 x 127 x 240 mm (5 x 5 x 9-1/2")
Dimensions (L x W x H)	
Net weight	1.6 - 2.2 kg (3.5 - 4.9 lbs.)

Bluetooth

40Vmax XGT XPT

Strap Hook, Battery and Charger are sold separately

**DMR057 Cordless Radio with Lantern**

18V/14.4V LXT Cordless Radio with Lantern

Li-ion Ah 6.0 5.0 3.0 1.5



Frequency Band	FM: 87.5-108 MHz
Speaker Size	Ø57 mm
Illuminance (High/Low)*	Flashlight: 1,000/500, Lantern: Daylight white 145/72, Neutral white 140/70, Warm white 130/65
Luminous flux (High/Low)	Flashlight: 200/100, Lantern: Daylight white 310/155, Neutral white 300/150, Warm white 260/130
Bluetooth	Version: 5.0, Profile: A2DP, SCMS-T, AVRCP, Supported Codec: SBC, Max Transmission Range (Optimum): 10 m (33 ft) w/o Battery: 126 x 127 x 240 mm (5 x 5 x 9-1/2")
Dimensions (L x W x H)	
Net weight	1.3 - 1.6 kg (2.9 - 3.5 lbs.)

Bluetooth

18V 14.4V LXT XPT

Strap Hook, Battery and Charger are sold separately

**Cordless Radio with Lantern that can be used at work, play, or anytime**

Lantern with 3 light tone settings\*

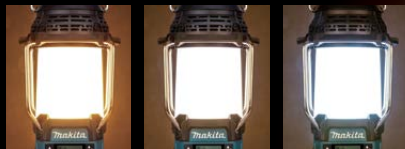

**Warm white**  
You will feel relaxed. (about 2,500K)

**Neutral white**  
(about 3,500K)

**Daylight white**  
You can easily read what is written / printed. (about 5,000K)

- Flashlight\***
- Daylight white single LED
  - Brightness settings (2 stages)
- USB output port\***
- With USB output switch
  - With Auto-off function
  - Type A, 1 port, DC5V/ 2.4A

\*MR010G / DMR057 only



# LIGHTS

## PRODUCTS



### ML009G Cordless Worklight

XGT LXT Li-Ion Cordless 96 LED Worklight, 10,000 Lumens

Li-ion Ah 8.0 | 5.0 | 4.0 | 2.5 | 2.0



Run Time (hrs)	w/ BL4040 x2, Low/Mid/High: 14/6.5/2.4 at 1m from the light source: 4,300/1,900/1,000 lx at 3m from the light source: 500/230/110 lx
Luminous Flux	High/Mid/Low: 10,000/4,000/2,000 lm
Dimensions (L x W x H)	w/ Handle in Retracted Position: 248 x 386 x 305 mm, w/ Handle in Upright Position: 248 x 386 x 430 mm
Net weight	6.4 - 9.9 kg (14.1 - 21.8 lbs.)

40Vmax 18V 14.4V XGT LXT

Anti-glare film, Battery and Charger are sold separately

### ML005GX Cordless Worklight

40Vmax XGT Li-Ion Cordless LED Worklight, 3,600 Lumens

Li-ion Ah 8.0 | 5.0 | 4.0 | 2.5 | 2.0



Illuminance (High / Mid / Low)	at 1m from the light source: 2,100 / 1,000 / 500 lx
Luminous Flux	High / Mid / Low: 3,600 / 1,800 / 900 lm
Dimensions (L x W x H)	w/ Handle in Retracted Position: 248 x 309 x 296 mm (9-3/4 x 12-1/8 x 11-5/8")
Net weight	4.6 - 6.5 kg (10.1 - 14.3 lbs.)

40Vmax 18V 14.4V XGT LXT

Battery and Charger are sold separately

### ML003G Cordless LED Worklight

High-intensity LED lights for wider range

Li-ion Ah 5.0 | 4.0 | 2.5 | 2.0



Run Time (hrs)	Up to: 22 (Low mode, with BL4040)
Illuminance (High / Mid / Low)	at 1m from the light source: 500 / 200 lx at 0.5m from the light source: 1,900 / 800 lx
Luminous Flux	High / Low: 1,100 / 450 lm
Dimensions (L x W x H)	w/ Handle in Retracted Position: 249x298x280mm (9-3/4"x11-3/4"x11") w/ Handle in Upright Position: 249x298x386 mm (9-3/4"x11-3/4"x15-1/4")
Net weight	3.7 - 4.7 kg (8.2 - 10.4 lbs.)

40Vmax 18V XGT LXT

Battery and Charger are sold separately

### DML811 18V, 14.4V / AC Cordless Worklight

30 super luminous daylight white LEDs

Li-ion Ah 6.0 | 5.0 | 3.0 | 1.5



Run Time (hrs)	Up to: 13
Illuminance (High / Mid / Low)	at 1m from the light source: 1,800 / 800 / 350 lx at 3m from the light source: 200 / 100 / 40 lx at 5m from the light source: 85 / 40 / 17 lx
Luminous Flux	High / Mid / Low: 3,000 / 1,500 / 750 lm
Dimensions (L x W x H)	w/ Handle in Retracted Position: 249 x 302 x 271 mm (9-3/4 x 11-7/8 x 10-5/8")
Net weight	4.1 - 4.8 kg (9.0 - 10.5 lbs.)

18V 14.4V LXT

AC Power Cord. Battery and Charger are sold separately

Power Supply Cord: 2.5 m (8.2 ft)

### DML809 18V, 14.4V / AC Cordless Worklight

Cordless 96 LED Worklight, 10,000 Lumens

Li-ion Ah 6.0 | 5.0 | 3.0 | 1.5



Run Time (hrs)	Up to: 8.5
Illuminance (High / Mid / Low)	at 1m from the light source: 3,800 / 1,500 / 800 lx at 3m from the light source: 380 / 150 / 80 lx at 5m from the light source: 150 / 60 / 30 lx
Luminous Flux	High / Mid / Low: 10,000 / 4,000 / 2,000 lm
Dimensions (L x W x H)	w/ Handle in Retracted Position: 249x370x278 mm (9-3/4"x14-1/2"x11") w/ Handle in Upright Position: 249x370x370 mm (9-3/4"x14-1/2"x14-1/2")
Net weight	5.7 - 7.0 kg (12.6 - 15.4 lbs.)

18V 14.4V LXT

AC Power Cord. Battery and Charger are sold separately

Power Supply Cord: 2.5 m (8.2 ft)

### DML805 Corded and Cordless LED Worklight

L.E.D. Lights Deliver Bright and Even Lighting For Large Workspaces

Li-ion Ah 6.0 | 5.0 | 3.0 | 1.5



Run Time (hrs)	Up to: 17
Illuminance	at 0.5m from the light source Hi: 1,150 lx, Lo: 750 lx at 1m from the light source Hi: 300 lx, Lo: 200 lx at 1m from the light source Hi: 750 lm, Lo: 450 lm
Luminous Flux	
Net weight	2.3 - 2.7 kg (5.1 - 5.9 lbs.)

18V 14.4V LXT

Battery and Charger are sold separately

Power supply cord: 2.5m (8.2ft)



# Lighting coverage\*

\*measured in accordance with ANSI

**DML805**

Front **2.3m**  
(side: 2.6m)

**ML003G**

Front **2.8m**  
(side: 3.0m)

**DML812**

Front **2.8m**  
(side: 3.0m)

**ML007G**

**DML813 / DML814**

Front **4.5m**  
(side: 5.3m)  
Front **4.7m**  
(side: 5.6m)

**DML811**

Front **6.0m**  
(side: 6.0m)

Long-distance irradiation

**640m**

Spot mode

## Luminous flux

<p><b>18V</b></p> <p><b>DML805</b></p> <p><b>750 lm</b></p>	<p><b>18V 40V max</b></p> <p><b>ML003G</b></p> <p><b>1,100 lm</b></p>	<p><b>18V</b></p> <p><b>DML812</b></p>	<p><b>40V max</b></p> <p><b>ML007G</b></p> <p><b>1,250 lm</b></p> <p>Spot+Flood mode</p>	<p><b>18V</b></p> <p><b>DML813 / DML814</b></p>	<p><b>18V</b></p> <p><b>DML811</b></p> <p><b>3,000 lm</b></p>
---	---	--	--	---	---

### DML813 / DML814 Cordless Worklight

Cordless 12 LED Worklight, 3,000 Lumens

<p><b>Li-ion</b> Ah 6.0   5.0   3.0   1.5</p>	<p><b>Run Time (hrs)</b> w/ BL1850(B) Low / Mid / High: 10 / 5.5 / 3</p> <p><b>Illuminance (High / Mid / Low)</b> at 1m from the light source: 1,250 / 750 / 400 lx at 3m from the light source: 130 / 80 / 40 lx at 5m from the light source: 50 / 30 / 15 lx</p> <p><b>Luminous Flux</b> High / Mid / Low: 3,000 / 1,700 / 900 lm</p> <p><b>Dimensions (L x W x H)</b> Folding Position: 260x216x1,000 mm (10-1/4"x8-1/2"x39-3/8") Operating Position (Max Height): 573x658x1,250-2,240 mm (22-1/2"x26"x49-1/4"-88")</p> <p><b>Net weight</b> DML813: 7.2-7.9 kgv DML814: 7.4-8.1 kg</p>
---	--

**DML813**

**DML814**

**18V 14.4V**

**LXT**

**1**

Shoulder Belt, Battery and Charger are sold separately

### ML010G 40Vmax, 18V, 14.4V / AC Cordless Area Worklight

40Vmax XGT / 18V, 14.4V LXT Li-Ion Cordless Area Worklight, 5,500 Lumens

<p><b>Li-ion</b> Ah 5.0   4.0   2.5   2.0</p>	<p><b>Illuminance (High / Med. / Low)</b> at 1 m from the light source: 550 / 300 / 150 lx at 3 m from the light source: 70 / 40 / 20 lx at 5 m from the light source: 25 / 15 / 7 lx</p> <p><b>Luminous flux</b> High / Med. / Low: 5,500 / 3,000 / 1,500 lm</p> <p><b>Continuous run time on full battery charge (High / Med. / Low)</b> w/ BL1860B x2: 4.5 / 8.5 / 16 hours w/ BL4040 x2: 6.5 / 11 / 21 hours</p> <p><b>Dimensions (L x W x H)</b> 490 x 490 x 814 mm</p> <p><b>Net weight</b> 14.4 - 19.2 kg (31.7 - 42.3 lbs.)</p>
---	---

**1**

**40Vmax 18V 14.4V**

**XGT LXT**

**1**

AC power cord, Battery and Charger are sold separately

Items of standard equipment and specifications may vary by country or area. Net weight and dimensions may differ by the type of battery.

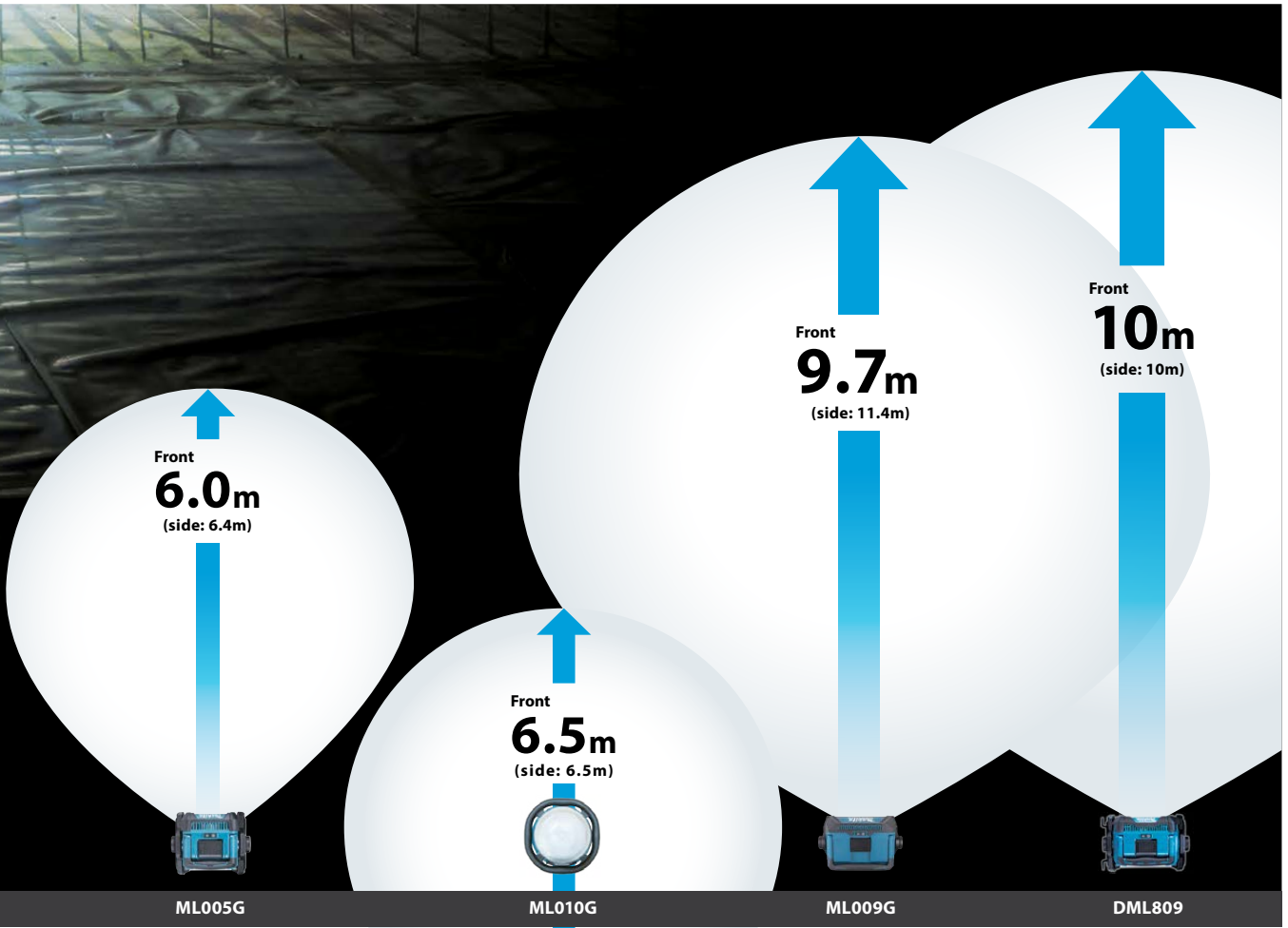

Up to 4 batteries can be installed in parallel.  
two LXT batteries + two XGT batteries



Continuous run time (approx) Low mode  
**59 hours**  
Battery: BL4080F x2 & BL1860B x2  
all LEDs light up

3 brightness settings with memory function of the setting last time you power off



Improved Self-righting performance



photo: ML010G





**DML810** 18V, 14.4V / AC Cordless Area Worklight

18V/14.4V LXT Li-Ion Cordless 202 LED Area Worklight, 5,500 Lumens

Li-ion Ah 6.0 5.0 3.0 1.5



Run Time (hrs)	Up to: 18
Illuminance (High / Mid / Low)	at 1m from the light source: 550 / 300 / 150 lx at 3m from the light source: 70 / 40 / 20 lx at 5m from the light source: 25 / 15 / 7 lx
Luminous Flux	High / Mid / Low: 5,500 / 3,000 / 1,500 lm
Dimensions (L x W x H)	420 x 420 x 787 mm (16-1/2 x 16-1/2 x 31")
Net weight	13.9 - 15.3 kg (30.6 - 33.7 lbs.)

Power Supply Cord: 2.5 m (8.2 ft)

18V 14.4V LXT XPT 1

AC Power Cord. Battery and Charger are sold separately

**ML007G** Cordless Flashlight

40Vmax XGT Li-Ion Flashlight Provides 500 Lumens

Li-ion Ah 8.0 5.0 4.0 2.5 2.0



Run Time (hrs)	Up to: 14 (Spot, with BL4050F)
Illuminance	Spot / Flood / Spot-Flood: 82,000 / 520 / 60,000 lx
Luminous Flux	Spot / Flood / Spot-Flood: 600 / 1,000 / 1,250 lm
Dimensions (L x W x H)	w/ BL4025: 330 x 120 x 118 mm (13 x 4-3/4 x 4-5/8")
Net weight	1.6 - 2.9 kg (3.5 - 6.4 lbs.)

40Vmax XGT XPT

Battery and Charger are sold separately

**DML812** Cordless Flashlight

LED Flashlight, 1,250 Lumens

Li-ion Ah 6.0 5.0 3.0 1.5



Run Time (hrs)	Up to: 10 (Spot, with BL1860B)
Illuminance	at 1m from the light source Spot Mode / Flood Mode / Spot-Flood Mode: 71,000 / 520 / 51,000 lx
Luminous Flux	Spot Mode / Flood Mode / Spot-Flood Mode: 600 / 1,000 / 1,250 lm
Dimensions (L x W x H)	w/ BL1830B / BL1850B / BL1860B: 313 x 119 x 115 mm (12-3/8" x 4-1/16" x 4-1/2")
Net weight	1.2 - 1.6 kg (2.6 - 3.4 lbs.)

Illuminance: at 1m from the light source

18V 14.4V LXT XPT 8

Strap Hook. Battery and Charger are sold separately

**ML001G** LED Flashlight

40Vmax XGT Li-Ion LED Flashlight, 160 Lumens

Li-ion Ah 8.0 5.0 4.0 2.5 2.0



Run Time (hrs)	Up to: 55
Luminous Flux	160 lm
Illuminance	at 1m from the light source: 3,000 lx
Dimensions (L x W x H)	w/ BL4025: 281 x 88 x 121 mm (11-1/8 x 3-1/2 x 4-3/4") w/ BL4040: 287 x 88 x 136 mm (11-1/4 x 3-1/2 x 5-3/8")
Net weight	1.0 - 1.3 kg (2.2 - 2.9 lbs.)

40Vmax XGT 12

Strap Hook. Battery and Charger are sold separately

**DML815** 18V, 14.4V Cordless LED Flashlight

18V / 14.4V LXT Li-Ion LED Flashlight, 160 Lumens

Li-ion Ah 6.0 5.0 3.0 1.5



Run Time (hrs)	Up to: 54
Luminous Flux	160 lm
Illuminance	at 1m from the light source: 3,000 lx
Dimensions (L x W x H)	w/ BL1830B / BL1850B / BL1860B: 272 x 79 x 116 mm (10-3/4" x 3-1/8" x 4-9/16")
Net weight	0.26 - 0.93 kg (0.57 - 2.05 lbs.)

18V 14.4V 5

Strap Hook. Battery and Charger are sold separately

**ML106** Cordless Flashlight

Multifaceted Reflector Illuminates Evenly for Increased Visibility

Li-ion Ah 5.0 4.0 2.0 1.5



Run Time (hrs)	Up to: 12
Luminous Flux	190 lm
Illuminance	at 1m from the light source: 170 - 4,500 lx
Dimensions (L x W x H)	w/ BL1016 / BL1021B: 271 x 66 x 93 mm (10-5/8 x 2-5/8 x 3-5/8") w/ BL1041B: 290 x 66 x 93 mm (11-3/8 x 2-5/8 x 3-5/8")
Net weight	0.61 - 0.78 kg (1.3 - 1.7 lbs.)

12Vmax XPT 8

Strap Hook. Battery and Charger are sold separately

**ML002G** Cordless LED Worklight

40Vmax XGT Li-Ion 21 LED Worklight, 710 Lumens

Li-ion Ah 5.0 4.0 2.5 2.0



Run Time (hrs)	Up to: 51
Main light (on bar side)	Luminous flux (Full brightness): 710 lm Illuminance (Full brightness): 340 lx Luminous flux (Half brightness): 340 lm Illuminance (Half brightness): 310 lx
Sub light (on top side)	Luminous flux: 130 lm Illuminance: 1,900 lx
Dimensions (L x W x H)	w/ BL4025: 376 x 86 x 126 mm w/ BL4040: 382 x 86 x 141 mm
Net weight	1.2 - 1.5 kg (2.7 - 3.3 lbs.)

Length (with the hook stood). Illuminance: at 50 cm from the light source

40Vmax XGT XPT 6

Battery and Charger are sold separately



**DML807 Cordless LED Flashlight**

18V / 14.4V LXT Li-Ion 21 LED Flashlight

Li-ion Ah 6.0 5.0 3.0 1.5



Run Time (hrs)	Up to: 43
Main light (on bar side)	Luminous flux (Full brightness): 710 lm Illuminance (Full brightness): 340 lx
Sub Light (on top side)	Luminous flux: 130 lm Illuminance: 1,900 lx
Dimensions (L x W x H)	414 x 79 x 155 mm (16-1/4 x 3-1/8 x 6-1/8")
Net weight	0.72 - 1.1 kg (1.6 - 2.4 lbs.)

Length (with the hook stood), Illuminance: at 50 cm from the light source

18V 14.4V LXT XPT USB

Battery and Charger are sold separately

**Rotatable and foldable light head**



**Foldable light head** **Rotatable light head** (90° right and 180° left)



Can be used as a compact stationary lamp with the light head swivelled and folded fully.

Max luminous flux  
**500 lm**



**ML006G Cordless Flashlight**

40Vmax XGT Li-Ion Flashlight Provides 500 Lumens

Li-ion Ah 5.0 4.0 2.5 2.0



Run Time (hrs)	Up to: 82 (Low mode, with BL4040)
Illuminance (at 0.5m from the light source)	High / Medium / Low: 800 / 400 / 180 lx
Luminous Flux	High / Medium / Low: 500 / 250 / 100 lm w/ BL4040:
Dimensions (L x W x H)	275 - 408 x 85 x 148 mm (10-7/8 - 16 x 3-3/8 x 5-7/8")
Net weight	1.1 - 1.7 kg (2.4 - 3.8 lbs.)

40Vmax XGT XPT

Shoulder hook set, Lamp shade, Battery and Charger are sold separately

**DML816 Cordless Flashlight**

18V LXT Li-Ion Flashlight Provides 500 Lumens

Li-ion 6.0 5.0 3.0 1.5



Run Time (hrs)	Up to: 75 (Low mode, with BL1860B)
Illuminance (at 0.5m from the light source)	High / Medium / Low: 800 / 400 / 180 lx
Luminous Flux	High / Medium / Low: 500 / 250 / 100 lm w/ BL1830B / BL1850B / BL1860B:
Dimensions (L x W x H)	267 - 400 x 79 x 127 mm (10-1/2 - 15-3/4 x 3-1/8 x 5")
Net weight	0.70 - 1.1 kg (1.5 - 2.4 lbs.)

18V 14.4V LXT XPT

Shoulder hook set, Lamp shade, Battery and Charger are sold separately



**ML011G Cordless Worklight**

40Vmax XGT Li-Ion Cordless Worklight, 300 Lumens

Li-ion Ah 5.0 4.0 2.5 2.0



Illuminance (at 0.5 m from the light source)	Sidelighting + Uplighting / Sidelighting only / Uplighting only: 240 / 190 / 190 lx
Luminous flux	Sidelighting + Uplighting / Sidelighting only / Uplighting only: 300 / 150 / 150 lm w/ BL4040, at 300 lm: 37, w/ BL4040, at 150 lm: 64
Run time (hrs)	w/o Battery: 107 x 77 x 50 mm
Dimensions (L x W x H)	
Net weight	0.19 kg (0.42 lbs.)

40Vmax XGT USB

Warm color cover, Battery and Charger are sold separately

**DML817 Cordless Worklight**

18V/14.4V LXT Li-Ion Cordless Worklight, 300 Lumens

Li-ion Ah 6.0 5.0 3.0 1.5



Illuminance (at 0.5 m from the light source)	Sidelighting + Uplighting / Sidelighting only / Uplighting only: 240 / 190 / 190 lx
Luminous flux	Sidelighting + Uplighting / Sidelighting only / Uplighting only: 300 / 150 / 150 lm w/ BL1860B, at 300 lm: 28, w/ BL1860B, at 150 lm: 49
Run time (hrs)	w/ BL1860B, at 300 lm: 28, w/ BL1860B, at 150 lm: 49
Dimensions (L x W x H)	107 x 77 x 50 mm
Net weight	0.21 kg (0.46 lbs.)

18V 14.4V LXT USB

Warm color cover, Battery and Charger are sold separately

**ML107 Cordless Worklight**

12Vmax CXT Li-Ion Cordless Worklight, 200 Lumens

Li-ion Ah 5.0 4.0 2.0 1.5



Illuminance (at 0.5 m from the light source)	Sidelighting + Uplighting / Sidelighting only / Uplighting only: 175 / 130 / 130 lx
Luminous flux	Sidelighting + Uplighting / Sidelighting only / Uplighting only: 200 / 100 / 100 lm w/ BL1041B, at 300 lm: 17, w/ BL1041B, at 150 lm: 29
Run time (hrs)	w/o Battery: 92 x 54 x 47 mm
Dimensions (L x W x H)	
Net weight	0.29 kg (0.13 lbs.)

12Vmax CXT USB

Warm color cover, Battery and Charger are sold separately



# As a charger for smartphones, tablets and more



## Adapter for USB ADP001G

40V max

Strap hole

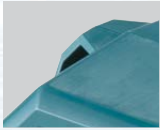

ON-OFF switch



Number of times iPhoneXR can be recharged on a single full battery charge

- BL4020 (2.0Ah): 2.8
- BL4025 (2.5Ah): 3.5
- BL4040 (4.0Ah): 5.6
- BL4050F (5.0Ah): 7.0

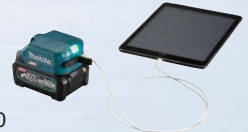

USB output port

- enables to charge two mobile devices at the same time
- Type A USB sockets for DC5V/ 2.1A (one port), 4.2A (two ports) USB output



## Adapter for USB ADP08

12V max



ON-OFF switch



Strap hole



USB output port

Type A USB port for DC5V/ 2.1A  
USB output



## Adapter for USB Series

ADP05 18V



ADP06 12V max



2 USB output ports with Caps provide 4.2A output for charging smart phones, tablets, etc.



Belt clip



Strap hole



# OPE TOOLS

## PRODUCTS



### UX01GZ Cordless Multi Function Power Head

High power BL motor enables to work under heavy load

Li-ion Ah 8.0 | 5.0 | 4.0 | 2.5 | 2.0



No Load Speed (RPM) High: 0-9,700  
Medium: 0-8,200  
Low: 0-5,700  
Dimensions (L x W x H) 1,027 x 320 x 209 mm (40-1/2 x 12-5/8 x 8-1/4")  
Net weight 4.1-4.7 kg (9.3-10.6 lbs.)

40Vmax



BL AFT WG XPT



Harness, Safety Goggles, Hex Wrench, Accessory Bag, Z: Battery and Charger are sold separately

### DUX60Z Cordless Multi Function Power Head

Multi Function System

Li-ion Ah 6.0 | 5.0 | 3.0 | 1.5



No Load Speed (RPM) High: 0-9,700  
Medium: 0-8,200  
Low: 0-5,700  
Dimensions (L x W x H) 1,011 x 320 x 216 mm (39-3/4 x 12-5/8 x 8-1/2")  
Net weight 4.1-8.7 kg (8.9-19.2 lbs.)

18V x2

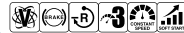

BL AFT XPT



Harness, Safety Goggles, Hex Wrench, Accessory Bag, Z: Battery and Charger are sold separately

## Optional attachments

### UX01G / DUX60 / DUX18

Consisting of power head and versatile optional attachments are ideal for a wide range of applications



**Rotary Scissors**  
EM407MP  
191M60-2



**Shaft extension**  
LE400MP  
191E23-0  
Length: 1,080mm (42-1/2")  
For Pole saw, Pole hedge trimmer and Coffee harvester



**Ground Trimmer**  
EN424MP  
1913D3-2



**Pump**  
PF400MP  
A-75384



This movie was filmed in Japan. Models and specs may vary by country.

**Grass trimmer**  
EM408MP  
191N35-7  
EM409MP  
191N48-8



**Coffee harvester**  
EJ400MP  
195726-8  
197163-2



**Cultivator**  
KR400MP / KR401MP  
195712-9 / 195716-1



**Edger**  
EE400MP  
196750-4



**Brushcutter**  
EM400MP / EM402MP  
195658-9 / 195952-9



**Blower**  
UB401MP  
191P78-1



**Power sweep**  
SW400MP  
199344-4

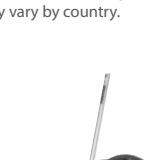

**Power brush**  
BR400MP  
199323-2

**Ground trimmer**  
EN420MP  
198061-3



**Pole saw**  
EY401MP  
199925-4



**Hedge trimmer**  
EN410MP / EN401MP  
197742-6 / 196341-1



**String trimmer**  
ER400MP  
195530-5





**DUX18Z Cordless Multi Function Power Head**

Multi Function System

Li-ion Ah 6.0 | 5.0 | 3.0 | 1.5



No Load Speed (RPM)	High: 0-9,700 Low: 0-6,800
Dimensions (L x W x H)	w/BL1830B / BL1850B / BL1860B: 977 x 318 x 175 mm (38-3/4 x 12-1/2 x 6-7/8")
Net weight	2.8-10.3 kg (6.2-22.7 lbs.)

18V



LXT BL AFT XPT



Harness, Safety Goggles, Hex Wrench, Accessory Bag, Z: Battery and Charger are sold separately

**UC003GZ01 300mm (12") Cordless Chain Saw**

40Vmax XGT BL Brushless Cordless 30 cm (12") Chain Saw

Li-ion Ah 5.0 | 4.0 | 2.5 | 2.0



Guide Bar Length	300 mm (12")
Chain Pitch	3/8"
Chain Gauge	1.1 mm (0.043")
Chain Speed	0-24.8 m/s (0-1,490 m/min) (0-4,880 FPM)
Chain Oil Tank Volume	200 mL (6.8 US oz)
Dimensions (L x W x H)	w/o Guide Bar :266 x 194 x 227 mm (10-1/2 x 7-5/8 x 8-15/16")
Net weight	3.9-4.5 kg (8.6-9.9 lbs.)

40Vmax



XGT BL AFT XPT



Saw Chain, Guide Bar, Guide Bar Cover, Box Wrench, Battery, Charger, Z: Battery and Charger are sold separately

**UC022GZ 350mm (14") Cordless Chain Saw**

New

40Vmax XGT BL Brushless Cordless 35 cm (14") Chain Saw

Li-ion Ah 8.0 | 5.0 | 4.0 | 2.5 | 2.0



Guide Bar Length	350 mm (14")
Recommended guide bar length	300-400 mm (12-16")
Chain type	80T XL
Chain Pitch	0.325"
Chain Gauge	1.1 mm (0.043")
Chain Speed	0-25.5 m/s
Chain Oil Tank Volume	200 mL (6.8 US oz)
Dimensions (L x W x H)	w/o Guide bar, w/BL4050F: 430 x 225 x 271 mm (17 x 8-7/8 x 10-5/8")
Net weight	5.1-5.5 kg (11.2-12.1 lbs.)

40Vmax



XGT BL AFT XPT

Guide bar, Saw chain, Guide bar case, Wrench, Round file, Chain oil, Battery, Charger, Z: Battery and Charger are sold separately

**UC012GT101(RT) / GZ 400mm (16") Cordless Chain Saw**

40Vmax XGT BL Brushless Cordless Chain Saw

Li-ion Ah 8.0 | 5.0 | 4.0 | 2.5 | 2.0



Guide Bar Length	400 mm (16")
Chain Pitch	3/8"
Chain Gauge	1.1 mm (0.043")
Chain Speed	0-24.7 m/s (0-1,482 m/min) (0-4,862 FPM)
Chain Oil Tank Volume	230 mL (7.8 US oz)
Dimensions (L x W x H)	w/o Guide Bar: 446 x 233 x 274 mm (17-1/2 x 9-1/8 x 10-3/4")
Net weight	6.0-6.5 kg (13.2-14.4 lbs.)

40Vmax



XGT BL AFT XPT



Saw Chain, Guide Bar, Guide Bar Cover, Box Wrench, Battery, Charger, Z: Battery and Charger are sold separately

**UC015GT101(RT) / GZ 350mm (14") Cordless Chain Saw**

40Vmax XGT BL Brushless Cordless Chain Saw

Li-ion Ah 8.0 | 5.0 | 4.0 | 2.5 | 2.0



Guide Bar Length	350 mm (14")
Chain Pitch	3/8"
Chain Gauge	1.1 mm (0.043")
Chain Speed	0-24.7 m/s (0-1,482 m/min) (0-4,862 FPM)
Chain Oil Tank Volume	230 mL (7.8 US oz)
Dimensions (L x W x H)	w/o Guide Bar: 446 x 233 x 274 mm (17-1/2 x 9-1/8 x 10-3/4")
Net weight	6.0-6.5 kg (13.2-14.4 lbs.)

40Vmax



XGT BL AFT XPT

Saw Chain, Guide Bar, Guide Bar Cover, Box Wrench, Battery, Charger, Z: Battery and Charger are sold separately

**UC014GT101(RT) / GZ 300mm (12") Cordless Chain Saw**

40Vmax XGT BL Brushless Cordless Chain Saw

Li-ion Ah 8.0 | 5.0 | 4.0 | 2.5 | 2.0



Guide Bar Length	300 mm (12")
Chain Pitch	3/8"
Chain Gauge	1.1 mm (0.043")
Chain Speed	0-24.7 m/s (0-1,482 m/min) (0-4,862 FPM)
Chain Oil Tank Volume	230 mL (7.8 US oz)
Dimensions (L x W x H)	w/o Guide Bar: 446 x 233 x 274 mm (17-1/2 x 9-1/8 x 10-3/4")
Net weight	6.0-6.5 kg (13.2-14.4 lbs.)

40Vmax



XGT BL AFT XPT



Saw Chain, Guide Bar, Guide Bar Cover, Box Wrench, Battery, Charger, Z: Battery and Charger are sold separately

**DUC353ZB 350mm (14") Cordless Chain Saw**

High efficiency equivalent to 30mL class engine chain saws

Li-ion Ah 6.0 | 5.0 | 3.0 | 1.5



Guide Bar Length	350 mm (14")
Chain Pitch /	9.5 mm (3/8") /
Chain Gauge	1.1 / 1.3 mm (.043" / .050")
Chain Speed	0-20 m/s (0-1,200 m/min)
Chain Oil Tank Volume	200 mL
Sound Power Level	98.7 dB(A)
Dimensions (L x W x H)	762 x 215 x 235 mm (30" x 8-1/2" x 9-1/4")
Net weight	4.7 kg - 5.4 kg (10.4 lbs - 11.8 lbs)

18V x2



LXT BL AFT XPT



Saw Chain, Guide Bar, Guide Bar Cover, Chain oil 100mL, Z: Battery and Charger are sold separately

**DUC355Z 350mm (14") Cordless Chain Saw**

High efficiency equivalent to 30mL class engine chain saws

Li-ion Ah 6.0 | 5.0 | 3.0 | 1.5



Guide Bar Length	350 mm (14")
Chain Pitch /	9.5 mm (3/8") /
Chain Gauge	1.1 / 1.3 mm (.043" / .050")
Chain Speed	0-20 m/s (0-1,200 m/min)
Chain Oil Tank Volume	200 mL
Sound Power Level	98.7 dB(A)
Dimensions (L x W x H)	762 x 215 x 235 mm (30" x 8-5/16" x 9-1/4")
Net weight	4.7 kg - 5.4 kg (10.4 lbs - 11.8 lbs)

18V x2



LXT BL AFT XPT



Saw Chain, Guide Bar, Guide Bar Cover, Chain oil 100mL, Wrench, Z: Battery and Charger are sold separately



**DUC306ZB 300mm (12") Cordless Chain Saw**

High efficiency equivalent to 30mL class engine chain saws

Li-ion Ah 6.0 5.0 3.0 1.5



Guide Bar Length	300 mm (12")
Chain Pitch / Chain Gauge	9.5 mm (3/8") / 1.1 or 1.3 mm (0.043" or 0.050")
Chain Speed	0-20 m/s (0-1,200 m/min) (0-3,940 FPM)
Chain Oil Tank Volume	200 mL (6.8 US oz)
Sound Power Level	103 dB(A)
Dimensions (L x W x H)	270-651 x 205 x 232 mm (10-5/8" x 8-1/8" x 9-1/8")
Net weight	4.6-5.1 kg (10.1-11.1 lbs.)

18V x2



LXT BL XPT 1

Saw Chain, Guide Bar, Guide Bar Cover, Chain oil 100mL, Wrench, Z: Battery and Charger are sold separately

**DUC357ZX4 350mm (14") Cordless Chain Saw**

Consistently powerful cutting action

Li-ion Ah 6.0 5.0 3.0 1.5



Guide Bar Length	350 mm (14")
Chain Pitch / Chain Gauge	3/8" / 1.1 mm (0.043") or 1.3 mm (0.050")
Chain Speed	7.7 m/s
Chain Oil Tank Volume	150 mL (5.1 US oz)
Sound Power Level	97 dB(A)
Dimensions (L x W x H)	762 x 214 x 234 mm (30 x 8-3/8 x 9-1/4")
Net weight	4.2-4.4 kg (9.3-9.7 lbs.)

18V



LXT BL XPT 1

Saw chain, Guide bar, Guide bar case, Battery, Charger, Z: Battery and Charger are sold separately

**DUC254Z 250mm (10") Cordless Chain Saw**

Efficiency equivalent to 23mL class engine chain saw

Li-ion Ah 6.0 5.0 3.0 1.5



Guide Bar Length	250 mm (10")
Chain Pitch / Chain Gauge	3/8" / 1.1 mm (0.043") / 3/8" / 1.3 mm (0.050")
Chain Speed	0-24 m/s (0-1,440 m/min) (0-4,720 FPM)
Chain Oil Tank Volume	140 mL
Sound Power Level	103.2 dB(A)
Dimensions (L x W x H)	w/o Guide Bar: 258x184x191 mm w/25 cm (10") 90PX Sprocket Nose Bar: 482x184x191 mm
Net weight	2.8-3.2 kg (6.2-6.9 lbs.)

18V



LXT BL XPT 3

Saw Chain, Guide Bar, Guide Bar Cover, Wrench, Accessory Bag, Z: Battery and Charger are sold separately



**DUC150Z 150mm (6") Cordless Pruning Saw**

New

Easy-to-use, compact product enables easy pruning of garden or orchard trees

Li-ion Ah 6.0 5.0 3.0 1.5



Guide bar length	150 mm (6")
Saw chain	Type: 80TXL Pitch: 0.325" Gauge: 1.1 mm (0.043")
Chain speed	8.0 m/s (480 m/min) (1,570 FPM)
Max cutting length	161 mm
Chain oil tank volume	55 mL (1.9 USoz)
Dimensions (L x W x H)	w/ BL1830B / BL1850B / BL1860B: 459 x 90 x 249 mm (18 x 3-1/2 x 9-3/4")
Net weight	1.7-2.0 kg (3.7-4.4 lbs.)

18V



Saw chain, Guide bar, Guide bar case, Battery, Charger, Z: Battery and Charger are sold separately

**UC100DZ 100mm (4") Cordless Pruning Saw**

Easy-to-use, compact product enables easy pruning of garden or orchard trees

Li-ion Ah 5.0 4.0 2.0 1.5



Guide bar length	100 mm (4")
Saw chain	Type: 80TXL Pitch: 0.325" Gauge: 1.1 mm (0.043")
Chain speed	8.0 m/s (480 m/min) (1,570 FPM)
Chain oil tank volume	55 mL (1.9 USoz)
Dimensions (L x W x H)	w/o Battery: 350 x 90 x 215 mm (13-3/4 x 3-1/2 x 8-1/2") w/ BL1041B: 398 x 90 x 226 mm (15-5/8 x 3-1/2 x 8-7/8")
Net weight	1.5-1.6 kg (3.3-3.5 lbs.)

12Vmax



Saw chain, Guide bar, Guide bar cover, Battery, Charger, DZ: Battery and Charger are sold separately

**Lightweight yet easy-to-use**

**Movable guard** covers the upper side of guide bar, and opens gradually wider as saw chain cuts deeper in branch.

**Lock-off lever accessible from both sides**



Guide bar length  
**150 mm**

photo: DUC150

Rear hand guard

**DUC150**

Work amount

**210 pcs.**

Battery: BL1830B

Test conditions:  
Cut ø50 cedar rod under an optimal pressing load of 20N or less on cutting edge. Saw chain: 80TXL



**Automatic chain lubrication**

**New Tool-less change and tension adjustment of saw chain**



**UC3541A 350mm (14") / UC4041A 400mm (16") Chain Saw**

Excellent in heavy duty application

132



Continuous Rating Input	1,800W
Chain Speed Per Minute	870m (2,900ft)
Saw Chain Pitch	3/8" / 1.1mm (.043")
Saw Chain Gauge	1.3mm (.050")
Sound Power Level	101.3dB(A)
Dimensions (L x W x H)	455x245x200mm (17-7/8"x9-5/8"x7-7/8")
Net Weight	4.7kg (10.3lbs)

Dimensions: excluding blade and guide bar



Chain Blade, Guide Bar Cover, Hook Complete

**UC3551A 350mm (14") / UC4051A 400mm (16") Chain Saw**

Large trigger switch with soft start for smooth start-ups

153



Continuous Rating Input	2,000W
Chain Speed Per Minute	870m (2,900ft)
Guide Bar Length	UC3551A: 350mm (14")
Saw Chain Pitch	3/8"
Saw Chain Gauge	1.3mm (.050")
Sound Power Level	101.8dB(A)
Dimensions (L x W x H)	505x200x220mm (19-7/8"x7-7/8"x8-5/8")
Net Weight	5.5kg (12.1lbs)
Power Supply Cord	0.3m (0.98ft)

Dimensions: excluding blade and guide bar



Chain Blade, Guide Bar Cover, Hook Complete

**UC4551A 450mm (18") Electric Chain Saw**

Heavy-duty for fast and efficient cutting

153



Continuous rating input	2,000W
Chain speed per minute	870 m (2,900 ft)
Guide Bar Length	450 mm (18")
Saw chain	Pitch: 3/8" Gauge: 1.3 mm (0.050")
Sound Power Level	101.8 dB(A)
Dimensions (L x W x H)	505x200x220 mm (19-7/8"x7-7/8"x8-5/8")
Net weight	5.7 kg (12.4 lbs.)
Power supply cord	0.3 m (0.98 ft)

Dimensions: excluding blade and guide bar



Saw Chain, Guide Bar Cover, Hook complete

**UA001GM102(RM) / GZ01 250mm (10") Cordless Pole Saw**

40Vmax XGT BL AFT 25 cm (10") Cordless Pole Saw

Li-ion Ah 8.0 5.0 4.0 2.5 2.0



Guide Bar Length	250 mm (10")
Saw chain	Gauge: 1.1 - 1.3 mm (0.043 - 0.050") Pitch: 3/8"
Chain Speed	0 - 20 m/s (0 - 1,200 m/min) (0 - 3,940 FPM)
Oil Tank Capacity	160 mL
Dimensions (L x W x H)	w/o Guide Bar: 2,228 x 157 x 189 mm (87-3/4 x 6-3/16 x 7-7/16")
Net weight	6.0 - 7.3 kg (13.2 - 16.1 lbs.)



Saw Chain, Guide Bar, Guide Bar Case, Wrench, Band Assembly, Battery, Charger, Z: Battery and Charger are sold separately

**UA002GM102(RM) / GZ01 250mm (10") Cordless Telescopic Pole Saw**

40Vmax XGT BL AFT 25 cm (10") Cordless Telescopic Pole Saw

Li-ion Ah 8.0 5.0 4.0 2.5 2.0



Guide Bar Length	250 mm (10")
Saw chain	Gauge: 1.1 - 1.3 mm (0.043 - 0.050") Pitch: 3/8"
Chain Speed	0 - 20 m/s (0 - 1,200 m/min) (0 - 3,940 FPM)
Oil Tank Capacity	160 mL
Dimensions (L x W x H)	w/o Guide Bar: 2,515 - 3,747 x 157 x 191 mm (99 - 147-1/2 x 6-3/16 x 7-7/16")
Net weight	7.6 - 8.9 kg (16.8 - 19.6 lbs.)



Saw Chain, Guide Bar, Guide Bar Case, Wrench, Hex Wrench, Band Assembly, Battery, Charger, Z: Battery and Charger are sold separately

**DUA301ZB 300mm (12") Cordless Telescopic Pole Saw**

High cutting efficiency

Li-ion Ah 6.0 5.0 3.0 1.5



Guide Bar Length	300 mm (12")
Saw chain	Gauge: 1.1 / 1.3 mm (0.043 / 0.050") Pitch: 3/8"
Chain Speed	0 - 20.0 m/s (0 - 1,200 m/min) (0 - 3,940 FPM)
Oil Tank Capacity	160 mL
Dimensions (L x W x H)	2,554 - 3,789 x 155 x 193 mm (100-1/2"-149" x 6-1/8" x 7-5/8")
Net weight	7.8 - 8.5 kg



Saw Chain, Guide Bar, Blade Cover, Wrench, Band Assembly, Hex Wrench, Battery, Charger, Z: Battery and Charger are sold separately



\*Saw head weight  
**0.7kg**

**Excellent tool balance**

The motor is located in the battery housing at the bottom of the tool. This bottom-mounted motor reduces the saw head weight, allowing for:

- Ease to control the saw head for easy access to a desired cutting position
- Reduced user fatigue and stress

\*without guide bar, saw chain and oil

No load chain speed  
**20.0 m/s**

**UA002G**  
Total length  
2,516 - 3,748mm\*  
Telescopic

**UA001G**  
Total length  
2,230mm\*  
Fixed length

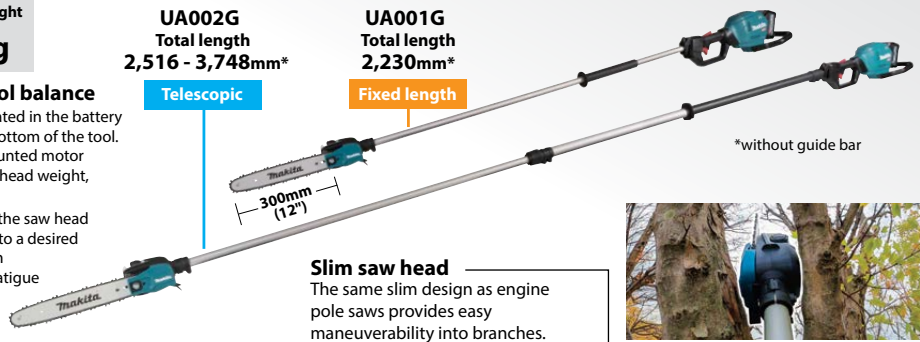

\*without guide bar

**Slim saw head**  
The same slim design as engine pole saws provides easy maneuverability into branches.

Retractable oil tank cap knob

Saw head width  
**87mm**



**DCU601Z Battery Powered Wheelbarrow (Electric Lift)**

**New**

4-Wheel Battery Powered Wheelbarrow, Electric Lift

Li-ion Ah 6.0 5.0 3.0 1.5



<b>Max load capacity</b>	Flat ground (0 - 3 degrees): 300 kg (661 lbs) Slope (3 - 12 degrees): 180 kg (397 lbs)
<b>Traveling Speed</b>	Forward: 0-1.5/3.5/5.0 km/h Reverse: 0-1.0 km/h
<b>Continuous use</b>	w/ BL1860B x4: 100 min
<b>Lift height</b>	475 - 1,020 mm (18-3/4 - 40-1/4")
<b>Max Climbing Capacity</b>	12°
<b>Dimensions (L x W x H)</b>	1,400 x 730 x 820 - 1,030 mm
<b>Net weight</b>	145 kg (320 lbs.)

18V x2



LXT BL MOTOR XPT

Z: Battery and Charger are sold separately

**DCU602Z Battery Powered Wheelbarrow (Electric Dump)**

**New**

4-Wheel Battery Powered Wheelbarrow, Bucket with Electric Dump

Li-ion Ah 6.0 5.0 3.0 1.5



<b>Max load capacity</b>	Flat ground (0 - 3 degrees): 300 kg (661 lbs) Slope (3 - 12 degrees): 180 kg (397 lbs)
<b>Traveling Speed</b>	Forward: 0-1.5/3.5/5.0 km/h Reverse: 0-1.0 km/h
<b>Continuous use</b>	w/ BL1860B x4: 100 min
<b>Bucket capacity</b>	Heaped capacity: 200 L
<b>Swivel range of dump unit</b>	90°
<b>Max Climbing Capacity</b>	12°
<b>Dimensions (L x W x H)</b>	at its smallest: 1,480 x 730 x 820 mm
<b>Net weight</b>	147 kg (324 lbs.)

18V x2



LXT BL MOTOR XPT

Z: Battery and Charger are sold separately



photo: DCU601

**Electric lift type**



photo: DCU602

**Electric dump type**



(elevated to 1,020mm in approximately 30 seconds.)

- The electric lift is limited to use on a flat ground, therefore, the machine is equipped with a level gauge to check the leveling of the machine.

**Loading platform size: 965 x 645 mm (L x W)**

- Reduces workload when dumping soil and other materials on the ground that are too heavy to lift manually.

- The electric dump is limited to use on a flat ground, therefore, the machine is equipped with a level gauge to check the leveling of the machine.



[Tilts electrically up to 75°]  
(Tilts to 75° in approx. 30 seconds.)



[Can be manually tilted for more than 75°]

**Max load capacity** on flat ground (0 - 3 degrees) **300 kg**

on slope (3 - 12 degrees) **180 kg**

**Traveling distance** **7.2 km**  
with BL1860B x 4

**Traveling speed change**

- Selection of 3 Forward speeds and F/R rotation by push button
- Stepless variable speed control by switch trigger in each range

Forward	Reverse
3 speeds (1.5/3.5/5.0 km/h)	1 speed (1.0 km/h)

**1 Hand brake lever**

- Brake for speed reduction while driving the wheelbarrow
- Can be used as a parking brake by locking this lever.

**2 Electric brake plus Electromagnetic brake**

**Electric brake**

- You can minimize the chance of load collapse by releasing the switch trigger to activate soft electric brake.

**Electric brake**

- Powerful electromagnetic brake is activated to keep the motor braked when the driving speed decreases almost to 0km.



**BL MOTOR**  
Max climbing ability **12°**

**DCU603Z Battery Powered Wheelbarrow**

18V X2 (36V) LXT BL 4-Wheel Battery Powered Wheelbarrow, 300 Kg Capacity

Li-ion Ah 6.0 | 5.0 | 3.0 | 1.5



<b>Max load capacity</b>	Flat ground (0 - 3 degrees): 300 kg (661 lbs) Slope (3 - 12 degrees): 180 kg (397 lbs)
<b>Traveling Speed</b>	Forward: 0-1.5/3.5/5.0 km/h Reverse: 0-1.0 km/h
<b>Max Climbing Capacity</b>	12°
<b>Dimensions (L x W x H)</b>	1,480 x 730 x 820 mm (32-1/4")
<b>Net weight</b>	122 - 124 kg (269 - 273 lbs.)

18V x2



Z: Battery and Charger are sold separately

**DCU604Z Battery Powered Wheelbarrow**

18V X2 (36V) LXT BL Brushless Battery Powered Wheelbarrow, 300 Kg Capacity

Li-ion Ah 6.0 | 5.0 | 3.0 | 1.5

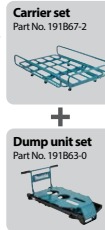

<b>Max load capacity</b>	Flat ground (0 - 3 degrees): 300 kg (661 lbs) Slope (3 - 12 degrees): 180 kg (397 lbs)
<b>Traveling Speed</b>	Forward: 0-1.5/3.5/5.0 km/h Reverse: 0-1.0 km/h
<b>Max Climbing Capacity</b>	12°
<b>Dimensions (L x W x H)</b>	1,450 x 730 x 820 mm (57 x 28-3/4 x 32-1/4")
<b>Net weight</b>	119 - 120 kg (262 - 265 lbs.)

18V x2



Z: Battery and Charger are sold separately

**DCU605Z Battery Powered Wheelbarrow**

18V X2 (36V) LXT BL Brushless Battery Powered Wheelbarrow, 300 Kg Capacity

Li-ion Ah 6.0 | 5.0 | 3.0 | 1.5



<b>Max load capacity</b>	Flat ground (0 - 3 degrees): 300 kg (661 lbs) Slope (3 - 12 degrees): 180 kg (397 lbs)
<b>Traveling Speed</b>	Forward: 0-1.5/3.5/5.0 km/h Reverse: 0-1.0 km/h
<b>Max Climbing Capacity</b>	12°
<b>Dimensions (L x W x H)</b>	1,440 x 730 x 820 mm (56-5/8 x 28-3/4 x 32-1/4")
<b>Net weight</b>	104 - 106 kg (229 - 234 lbs.)

18V x2



Z: Battery and Charger are sold separately



**DCU180Z Battery Powered Wheelbarrow**

Moving cart powered by one or two LXT Li-ion batteries

Li-ion Ah 6.0 | 5.0 | 3.0 | 1.5



<b>Max Run Time (min)</b>	with BL1860B: 120 130 kg (290 lbs.)
<b>Max Load Capacity</b>	130 kg (290 lbs.)
<b>Traveling Speed</b>	Forward, High / Low: 0 - 3.5 / 0 - 1.5 km/h Reverse: 0 - 1 km/h
<b>Max Climbing Capacity</b>	12°
<b>Dimensions (L x W x H)</b>	When carrier is installed / During operation: 1,315x1,060x900 mm (51-3/4"x41-3/4"x35-1/2") 39.3 - 44.8 kg (86.5 - 98.7 lbs)
<b>Net weight</b>	

18V



Lock Key, Support Legs, Wrenches, Z: Battery and Charger are sold separately

**UH014GZ 750mm (29-1/2") Cordless Hedge Trimmer**

40Vmax XGT BL Brushless Cordless 75 cm (29-1/2") Hedge Trimmer

Li-ion Ah 5.0 | 4.0 | 2.5 | 2.0



<b>Blade Length</b>	750 mm (29-1/2")
<b>Max Cutting Capacity</b>	18 mm (11/16")
<b>Strokes Per Minute (SPM)</b>	High / Mid / Low: 5,000 / 3,600 / 2,000
<b>Dimensions (L x W x H)</b>	w/o Battery: 1,225 x 270 x 135 mm w/ BL4020 / BL4025: 1,225 x 270 x 135 mm w/ BL4040: 1,225 x 270 x 150 mm w/ BL4050F: 1,225 x 270 x 168 mm
<b>Net weight</b>	4.0 - 4.7 kg (8.8 - 10.4 lbs.)

40Vmax



Blade Cover, Chip Receiver, Battery, Charger, Z: Battery and Charger are sold separately

**UH006GZ 600mm (23-5/8") Cordless Hedge Trimmer**

Reliable cutting performance like engine/AC hedge trimmers

Li-ion Ah 5.0 | 4.0 | 2.5 | 2.0



<b>Blade Length</b>	600 mm (23-5/8")
<b>Max Cutting Capacity</b>	25.0 mm (1")
<b>Strokes Per Minute (SPM)</b>	High / Mid / Low: 4,000 / 3,000 / 2,000
<b>Sound Pressure Level</b>	81 dB(A)
<b>Sound Power Level</b>	92 dB(A)
<b>Vibration Level</b>	Front / Rear: 3.0 / 2.5 m/s <sup>2</sup> or less w/ BL4020 / BL4025: 1,123 x 223 x 191 mm (44-1/4 x 8-3/4 x 7-1/2")
<b>Dimensions (L x W x H)</b>	
<b>Net weight</b>	4.4 - 5.0 kg (9.7 - 11.0 lbs.)

40Vmax



Blade Cover, Chip Receiver, Battery, Charger, Z: Battery and Charger are sold separately

**DUH754SZ 750mm (29-1/2") Cordless Hedge Trimmer**

18V LXT BL Brushless Cordless 75 cm (29-1/2") Hedge Trimmer

Li-ion Ah 6.0 | 5.0 | 3.0 | 1.5



<b>Blade Length</b>	750 mm (29-1/2")
<b>Max Cutting Capacity</b>	23.5 mm (15/16")
<b>Sound Pressure Level</b>	80.6 dB(A)
<b>Sound power level</b>	91.6 dB(A)
<b>Vibration Level</b>	2.5 m/s <sup>2</sup> or less
<b>Strokes Per Minute (SPM)</b>	High / Med / Low: 0 - 4,400 / 0 - 3,600 / 0 - 2,000
<b>Dimensions (L x W x H)</b>	1,198x280x147 mm (47-1/4"x11"x5-3/4")
<b>Net weight</b>	4.1 kg (9.0 lbs.)

18V



Blade Cover, Battery, Charger, Z: Battery and Charger are sold separately



**DUH604SZ 600mm (23-5/8") Cordless Hedge Trimmer**

18V LXT BL Brushless Cordless 60 cm (23-5/8") Hedge Trimmer

Li-ion Ah 6.0 5.0 3.0 1.5



Blade Length	600 mm (23-5/8")
Max Cutting Capacity	23.5 mm (15/16")
Sound Pressure Level	79.3 dB(A)
Sound power level	90.3 dB (A)
Vibration Level	2.5 m/s <sup>2</sup> or less
Strokes Per Minute (SPM)	High / Med / Low: 0 - 4,400 / 0 - 3,600 / 0 - 2,000
Dimensions (L x W x H)	1,057x280x147 mm (41-1/2"x11"x5-3/4")
Net weight	4.0 kg (8.8 lbs.)

18V



**LXT BL XPT**



Blade Cover, Battery, Charger, Z: Battery and Charger are sold separately

**DUH751Z 750mm (29-1/2") Cordless Hedge Trimmer**

18V LXT BL Brushless Cordless 75 cm (29-1/2") Hedge Trimmer

Li-ion Ah 6.0 5.0 3.0 1.5



Blade Length	750 mm (29-1/2")
Strokes Per Minute (SPM)	High / Med / Low: 0 - 4,400 / 0 - 3,600 / 0 - 2,000
Vibration Level	2.5 m/s <sup>2</sup>
Sound Power Level	97 dB(A)
Dimensions (L x W x H)	1,261x225x192 mm (49-1/2"x8-7/8"x7-1/2")
Net weight	3.8 - 4.5 kg (8.4 - 9.8 lbs.)

18V



**LXT BL XPT**



Blade Cover, Battery, Charger, Z: Battery and Charger are sold separately

**DUH601Z 600mm (23-5/8") Cordless Hedge Trimmer**

18V LXT BL Brushless Cordless 60 cm (23-5/8") Hedge Trimmer

Li-ion Ah 6.0 5.0 3.0 1.5



Blade Length	600 mm (23-5/8")
Strokes Per Minute (SPM)	High / Med / Low: 0 - 4,400 / 0 - 3,600 / 0 - 2,000
Vibration Level	2.5 m/s <sup>2</sup> or less
Sound Power Level	95 dB(A)
Dimensions (L x W x H)	1,121x225x192 mm (44-1/4"x8-7/8"x7-1/2")
Net weight	3.8 - 4.5 kg (8.4 - 9.8 lbs.)

18V



**LXT BL XPT**



Blade Cover, Chip Receiver, Battery, Charger, Z: Battery and Charger are sold separately

**DUH502Z 500mm (19-3/4") Cordless Hedge Trimmer**

18V LXT BL Brushless Cordless 50 cm (19-3/4") Hedge Trimmer

Li-ion Ah 6.0 5.0 3.0 1.5



Blade Length	500 mm (19-5/8")
Strokes Per Minute (SPM)	High / Med / Low: 0 - 4,400 / 0 - 3,600 / 0 - 2,000
Vibration Level	2.5 m/s <sup>2</sup>
Sound Power Level	86.8 dB(A)
Dimensions (L x W x H)	1,016x225x192 mm (40"x8-7/8"x7-1/2")
Net weight	3.7 - 4.4 kg (8.2 - 9.7 lbs.)

18V



**LXT BL XPT**



Blade Cover, Battery, Charger, Z: Battery and Charger are sold separately

**DUH606Z 600mm (23-5/8") Cordless Hedge Trimmer**

18V LXT BL Brushless Cordless 60 cm (23-5/8") Hedge Trimmer

Li-ion Ah 6.0 5.0 3.0 1.5



Blade Length	600 mm (23-5/8")
Max Cutting Capacity	20.0 mm (13/16")
Strokes Per Minute (SPM)	4,000
Continuous Use (min.)	w/ BL1860B: 70
Dimensions (L x W x H)	1,016 x 207 x 185 mm (40 x 8-1/8 x 7-1/4")
Net weight	2.7 - 3.0 kg (6.0 - 6.6 lbs.)

18V



**LXT BL XPT**



Blade Cover, Battery, Charger, Z: Battery and Charger are sold separately

**DUH506Z 500mm (19-3/4") Cordless Hedge Trimmer**

18V LXT BL Brushless Cordless 50 cm (19-3/4") Hedge Trimmer

Li-ion Ah 6.0 5.0 3.0 1.5



Blade Length	500 mm (19-5/8")
Max Cutting Capacity	20.0 mm (13/16")
Strokes Per Minute (SPM)	4,000
Continuous Use (min.)	w/ BL1860B: 75
Dimensions (L x W x H)	897 x 207 x 185 mm (35-1/4 x 8-1/8 x 7-1/4")
Net weight	2.5 - 2.9 kg (5.5 - 6.4 lbs.)

18V



**LXT BL XPT**



Blade Cover, Battery, Charger, Z: Battery and Charger are sold separately



**DUH507F001 / Z 500mm (19-3/4") Cordless Hedge Trimmer**

Large main switch lever for improved switch operation

Li-ion Ah 6.0 5.0 3.0 1.5



Blade Length	500 mm (19-5/8")
Effective cutting length	498 mm (19-5/8")
Max branch dia.	15 mm (9/16")
Tooth spacing	28 mm (1-1/8")
Strokes Per Minute (SPM)	2,700
Continuous Use (min.)	w/ BL1830B: 77
Dimensions (L x W x H)	w/ BL1830B / BL1850B / BL1860B: 925 x 209 x 188 mm (36-1/2 x 8-1/4 x 7-3/8")
Net weight	2.7 - 3.0 kg (6.0 - 6.6 lbs.)

18V



**LXT XPT**



Blade cover, Battery, Charger, Z: Battery and Charger are sold separately

**UH353DSA / DZ**  
350mm (13-3/4") Cordless Hedge Trimmer

Lightweight, Low Vibration, Low Noise

Li-ion Ah 5.0 4.0 2.0 1.5



Max Output Power	170W
Cycles Per Minute (cpm)	1,650
Strokes Per Minute (SPM)	3,300
Cutting width	350 mm (13-3/4")
Max Cutting Capacity	15mm (9/16)
Dimensions (L x W x H)	693 x 175 x 165mm (27-1/4 x 6-7/8 x 6-1/2)
Net weight	2 - 2.1 kg (4.3 - 4.7 lbs.)

12Vmax



Blade Cover, Battery, Charger, DZ: Battery and Charger are sold separately

**DUN500WZ** 500mm (19-3/4") Cordless Pole Hedge Trimmer

18V LXT BL Brushless Cordless Pole Hedge Trimmer

Li-ion Ah 6.0 5.0 3.0 1.5



Blade Length	500 mm (19-3/4")
Max Cutting Capacity	23.5 mm (15/16")
Sound Pressure Level	81.5 dB(A)
Sound Power Level	92.5 dB (A)
Vibration Level	
Left hand (Front grip / Handle)	4.7 m/s2
Right hand (Rear grip)	2.5 m/s2 or less
Strokes Per Minute (SPM)	High / Med / Low: 4,400 / 3,600 / 2,000
Overall length	2,115 mm
Net weight	4.5 kg (9.9 lbs.)

18V



Blade Cover, Harness, Battery, Charger, Z: Battery and Charger are sold separately

**Length adjustable telescopic system**

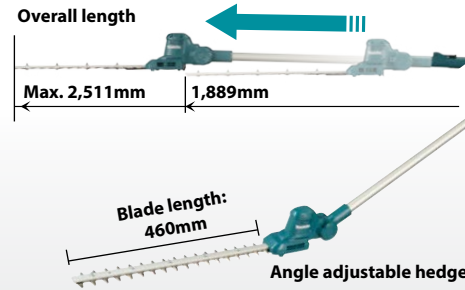
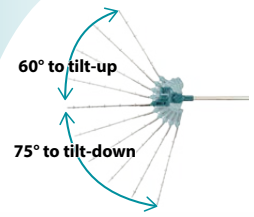

photo: DUN461W

**Lock lever** for tool-less easy adjustment of pole extension

**Slide-type front grip** position is adjustable for personal fit and comfort maximum work efficiency in different working postures



**Angle adjustable hedge trimmer head**

- 60° tilt-up to 75° tilt-down from the horizontal position.
- 10 angle settings (60°, 45°, 30°, 15°, 0°, -15°, 30°-45°, -60°, 75°)

<b>Strokes per minute</b> High speed mode (No load speed)	<b>3,600 min<sup>-1</sup></b>
<b>Run time*</b> DUN461W / BL1850B / UN460WD / BL1041B	<b>122 / 53 min</b>

**DUN461WSF / WZ**  
460mm (18-1/8") Cordless Pole Hedge Trimmer

Telescopic pipe for no need of stepladders

Li-ion Ah 6.0 5.0 3.0 1.5



Blade Length	460 mm (18-1/8")
Max Cutting Capacity	18 mm (11/16")
Strokes Per Minute (SPM)	3,600
Cycles Per Minute (CPM)	1,800
Continuous Use (min.)	w/BL1830B: 60
Dimensions (L x W x H)	1,889 - 2,511 x 87 x 133 mm (74-1/2 - 99 x 3-7/16 x 5-1/4")
Net weight	w/BL1860B: 3.4 kg (7.5 lbs.)

18V



Blade Cover, Battery, Charger, Z: Battery and Charger are sold separately

**UN460WDZ**  
460mm (18-1/8") Cordless Pole Hedge Trimmer

12Vmax LXT Cordless 46 cm (18-1/8") Pole Hedge Trimmer

Li-ion Ah 5.0 4.0 2.0 1.5



Blade Length	460 mm (18-1/8")
Max Cutting Capacity	18 mm (11/16")
Strokes Per Minute (SPM)	3,600
Cycles Per Minute (CPM)	1,800
Dimensions (L x W x H)	1,889 - 2,511 x 87 x 133 mm (74-1/2 x 99 x 3-7/16 x 5-1/4")
Net weight	3.0 kg (6.6 lbs.)

12Vmax



Blade Cover, Battery, Charger

**UH201DZ**  
200mm (7-7/8") Cordless Hedge Trimmer

12Vmax CXT Li-Ion Cordless 20 cm (7-7/8") Hedge Trimmer

Li-ion Ah 5.0 4.0 2.0 1.5



Blade Length	200 mm (7-7/8")
Strokes Per Minute (SPM)	2,500
Dimensions (L x W x H)	504 x 120 x 131 mm (19-7/8 x 4-3/4 x 5-1/8")
Net Weight	1.3 - 1.5 kg (2.8 - 3.3 lbs)

12Vmax



Base Frame, Blade Cover, Battery, Charger

**DUM604SF / Z** 160mm (6-5/16") Cordless Grass Shear

18V LXT Li-Ion Cordless 16 cm (6-5/16") Grass Shear

Li-ion Ah 6.0 5.0 3.0 1.5



Cutting Width	160 mm (6-5/16")
Depth Adjustment	15, 20, 25 mm (9/16"; 13/16"; 1")
Strokes Per Minute (SPM)	2,500
Continuous Use (min.)	with BL1860B / BL1850B / BL1840B / BL1830B / BL1820B / BL1815N: 250 / 200 / 160 / 125 / 80 / 60
Dimensions (L x W x H)	337x177x131 mm (13-1/4 x 7 x 5-1/8")
Net weight	1.4 - 1.8 kg (3.2 - 4.0 lbs)

18V



Grass Receiver, Blade Cover, Z: Battery and Charger are sold separately



**DUM111SYX 110mm Cordless Grass Shear**

11 cm cutting width for optimum performance

Li-ion Ah 6.0 | 5.0 | 3.0 | 1.5



Cutting Width	110 mm
Strokes Per Minute (SPM)	2,500
Continuous Use (min.)	with BL1860B / BL1850B / BL1830B / BL1820B / BL1815N: - / - / - / - / 45
Dimensions (L x W x H)	333 x 120 x 131 mm
Net weight	1.4 - 1.7 kg (3.2 - 3.8 lbs.)

18V



Blade Cover, Battery, Charger

**UM600DSYEX / DWA / DZ 160mm (6-5/16") Cordless Grass Shear**

12Vmax CXT Li-Ion Cordless 16 cm (6-5/16") Grass Shear

Li-ion Ah 5.0 | 4.0 | 2.0 | 1.5



UM600DSYEX

Cutting Width	160 mm (6-5/16")
Strokes Per Minute (SPM)	2,500
Dimensions (L x W x H)	329x177x131 mm (13"x7"x5-1/8")
Net Weight	1.3 - 1.5 kg (2.8 - 3.3 lbs)

12Vmax



Base Frame, Blade Cover, Battery, Charger, DZ: Battery and Charger are sold separately

**Tool-less blade change system**

- Grass shear blade can be removed / installed without tool.
- Hedge trimmer blade can be removed / installed by using a coin to loosen / tighten two screws.



**UR012GZ04 Cordless Grass Trimmer**

80Vmax XGT BL ADT AFT Cordless 3-Speed Grass Trimmer, Bike Handle

Li-ion Ah 8.0 | 5.0 | 4.0 | 2.5 | 2.0



Cutting Width	Metal Blade: 305 mm TCT Saw Blade: 255 mm Chisel Blade: 225 mm Nylon Cutting Head: 480 mm Shredder Blade: 270 mm Plastic Blade: 305 mm
No Load Speed (RPM)	Metal Blade (3/2/1): 0 - 6,800 / 0 - 5,000 / 0 - 3,500 Nylon Cutting Head (3/2/1): 0 - 5,000 / 0 - 4,200 / 0 - 3,500 Plastic Blade (3/2/1): 0 - 6,800 / 0 - 5,000 / 0 - 3,500
Spindle Size	M10 x 1.25 LH
Net weight	8.0 - 9.3 kg (17.6 - 20.5 lbs.)

40Vmax x2



Safety Goggles, Metal Blade / Nylon Cutting Head, Blade Cover (for the product with metal blade), Accessory Bag, Hex Wrench, Box Wrench, Shoulder Belt, Battery, Charger, Z: Battery and Charger are sold separately

**UR013GZ03 Cordless Grass Trimmer**

40Vmax XGT BL AFT Cordless Grass Trimmer, Bike Handle

Li-ion Ah 8.0 | 5.0 | 4.0 | 2.5 | 2.0



Cutting Width	Metal Blade: 255 mm Chisel Blade: 225 mm Nylon Cutting Head: 450 mm Shredder Blade: 270 mm Plastic Blade: 305 mm
No Load Speed (RPM)	0 - 6,700
Spindle Size	M10 x 1.25 LH
Dimensions (L x W x H)	1,905 x 688 x 574 mm (75 x 27 x 22-5/8")
Net weight	5.9 - 7.3 kg (13.0 - 16.1 lbs.)

40Vmax



Metal blade / Nylon cutting head, Accessory bag, Hex wrench, Box driver, Shoulder belt, Battery, Charger, Z: Battery and Charger are sold separately

**UR008GM101(RM) / GZ01 Cordless Grass Trimmer**

40Vmax XGT BL ADT AFT Cordless 3-Speed Grass Trimmer, Loop Handle

Li-ion Ah 8.0 | 5.0 | 4.0 | 2.5 | 2.0



Cutting Width	Nylon Cutting Head: 430 mm (17") Plastic Blade: 305 mm (12")
No Load Speed (RPM)	Nylon Cutting Head (3/2/1): 0 - 5,000 / 0 - 4,600 / 0 - 4,000 Plastic Blade (3/2/1): 0 - 6,000 / 0 - 4,600 / 0 - 4,000
Spindle Size	M10 x 1.25 LH
Dimensions (L x W x H)	w/o Cutting Tool, w/o Battery: 1,803 x 224 x 300 mm (71 x 8-7/8 x 11-3/4")
Net weight	5.0 - 5.7 kg (11.0 - 12.6 lbs.)

40Vmax



Safety Goggles, Nylon Cutting Head, Accessory Bag, Hex Wrench, Battery, Charger, Z: Battery and Charger are sold separately

**UR003GZ Cordless Grass Trimmer**

40Vmax XGT BL ADT AFT Cordless 3-Speed Grass Trimmer, Loop Handle

Li-ion Ah 8.0 | 5.0 | 4.0 | 2.5 | 2.0



Cutting Width	Metal Blade: 230 mm (9") Nylon Cutting Head: 350 mm (13-3/4") Plastic Blade: 255 mm (10")
No Load Speed (RPM)	High / Mid / Low: 0 - 6,500 / 5,300 / 3,500
Spindle Size	M10 x 1.25 LH
Dimensions (L x W x H)	w/o Cutting Tool, w/BL4020 / BL4025 / BL4040: 1,735 x 355 x 230 mm (68-1/4 x 14 x 9")
Net weight	4.1 - 4.7 kg (9.0 - 10.4 lbs.)

40Vmax



Safety Goggles, Metal Blade / Nylon Cutting Head, Blade Cover (for the product with metal blade), Accessory Bag, Hex Wrench, Box Driver, Shoulder Belt, Battery, Charger, Z: Battery and Charger are sold separately

### UR017GZ Cordless Grass Trimmer

40Vmax XGT BL ADT AFT Cordless 3-Speed Grass Trimmer, Loop Handle

Li-ion Ah 5.0 4.0 2.5 2.0



Cutting Width	Metal blade: 230 mm (9")
	Nylon cutting head: 330 mm (13")
	Plastic blade: 255 mm (10")
No Load Speed (RPM)	High / Med. / Low: 6,500 / 5,300 / 3,500
Spindle size	M10 x 1.25 LH
Dimensions (L x W x H)	1,890 x 362 x 265 mm (74-1/2 x 14-1/4 x 10-3/8")
Net weight	4.2 - 4.8 kg (9.3 - 10.6 lbs.)

40Vmax



Nylon cutting head, Plastic blade, Shoulder belt, Box driver, Hex wrench, Accessory bag, Battery, Charger, Z: Battery and Charger are sold separately



### Grass tangle removing function

Reverse switch for clearing entangled weeds and grass from cutting head

### Lightweight design

**4.8 kg**

with battery BL4050F without Cutting tool and Shoulder strap

photo: UR017G

### UR202CZ Battery Powered Grass Trimmer

BL ADT AFT Battery Powered 3-Speed Grass Trimmer



Cutting Width	Nylon cutting head: 430 mm (17")
	Plastic blade: 305 mm (12")
No Load Speed (RPM)	Nylon cutting head (3 / 2 / 1): 0 - 5,000 / 0 - 4,600 / 0 - 4,000
Spindle Size	M10 x 1.25 LH
Dimensions (L x W x H)	1,783 x 226 x 300 mm (70-1/4 x 8-15/16 x 11-7/8")
Net weight	5.5 - 6.1 kg (12.1 - 13.5 lbs.)

Li-ion



Safety Goggles, Metal Blade / Nylon Cutting Head, Blade cover (for the product with metal blade), Accessory Bag, Hex Wrench, Box Driver, Shoulder Belt, Battery, Charger

### DUR369LZ Cordless Grass Trimmer

18V X2 (36V) LXT BL ADT AFT Cordless 3-Speed Grass Trimmer

Li-ion Ah 6.0 5.0 3.0 1.5



Cutting Width	Metal Blade: 255 mm (10")
	Trimmer Head: 430 mm (17")
	Plastic Blade: 305 mm (12")
No Load Speed (RPM)	High / Med / Low: 3,300-7,000 / 5,500 / 4,600
Spindle Size	M10 x 1.25 LH
Dimensions (L x W x H)	1,846 x 400 x 269 mm (72-1/2" x 15-3/4" x 10-5/8")
Net weight	5.8 - 6.4 kg (12.8 - 14.1 lbs.)

18V x2

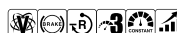

Safety Goggles, Metal Blade / Nylon Cutting Head, Blade cover (for the product with metal blade), Accessory Bag, Hex Wrench, Shoulder Belt, Battery, Charger

### DUR368LZ Cordless Grass Trimmer

18V X2 (36V) LXT BL ADT AFT Cordless 3-Speed Grass Trimmer

Li-ion Ah 6.0 5.0 3.0 1.5



Cutting Width	Metal Blade: 255 mm (10")
	Trimmer Head: 350 mm (13-3/4")
	Plastic Blade: 255 mm (10")
No Load Speed (RPM)	High / Med / Low: 6,500 / 5,300 / 3,500
Spindle Size	M10 x 1.25 LH
Sound Power Level	4-Tooth Blade: 89.2 dB(A) Nylon Cutting Head: 89 dB(A)
Dimensions (L x W x H)	1,758 x 362 x 231 mm (69-1/4" x 14-1/4" x 9-1/8")
Net weight	3.9 - 4.5 kg (8.6 - 10.0 lbs.)

18V x2



Safety Goggles, Metal Blade / Nylon Cutting Head, Blade cover (for the product with metal blade), Accessory Bag, Hex Wrench, Box Driver, Shoulder Belt, Battery, Charger

### DUR189Z Cordless Grass Trimmer

18V LXT BL ADT Cordless Grass Trimmer, Short Telescopic Pipe, Loop Handle

Li-ion Ah 6.0 5.0 3.0 1.5



Cutting Width	Trimmer Head: 300 mm (11-3/4")
	Plastic Blade: 255 mm (10")
No Load Speed (RPM)	High / Mid / Low / ADT Mode: 6,000 / 5,000 / 4,000 / 4,000 - 6,000
Spindle Size	M8 x 1.25 RH
Max Run Time (min)	Nylon Cutting Head, BL1860B: 168 Plastic Blade, BL1860B: 219
Net weight	3 - 3.3 kg (6.6 - 7.3 lbs.)

18V



Shoulder Strap, Nylon Cutting Head, Plastic Blade, Safety Goggles, Accessory Bag, Hex Wrench, Battery, Charger, Z: Battery and Charger are sold separately

### DUR194SFX2 Cordless Grass Trimmer

18V LXT Li-Ion Cordless 2-Speed Grass Trimmer, Loop Handle

Li-ion Ah 6.0 5.0 3.0 1.5



Cutting Width	Metal Blade: 200 mm (7-7/8")
	Trimmer Head: 280 mm (11")
	Plastic Blade: 230 mm (9")
No Load Speed (RPM)	High / Low: 6,000 / 4,500
Spindle Size	M10 x 1.25 LH
Dimensions (L x W x H)	1,630 x 288 x 236 mm (64 x 11-3/8 x 9-1/4")
Net weight	2.6 - 2.9 kg (5.7 - 6.4 lbs.)

18V



Shoulder Belt, Nylon Cutting Head, Metal Blade / Nylon Cutting Head, Hex Wrench, Box Driver, Accessory Bag, Battery, Charger, Z: Battery and Charger are sold separately

### DUR193SF / Z Cordless Grass Trimmer

18V LXT Li-Ion Cordless Grass Trimmer

Li-ion Ah 6.0 5.0 3.0 1.5



Cutting Width	Trimmer Head: 260 mm (10-1/4")
No Load Speed (RPM)	7,800
Max Run Time (min)	w/ BL1830B: 45
Dimensions (L x W x H)	1,194 - 1,384 x 271 x 372 mm (47 - 54-1/2 x 10-5/8 x 14-5/8")
Net weight	2.4 - 2.7 kg (5.3 - 6.0 lbs.)

18V



Shoulder Belt, Nylon Cutting Head, Metal Blade / Nylon Cutting Head, Hex Wrench, Box Driver, Accessory Bag, Battery, Charger, Z: Battery and Charger are sold separately



**DUR181Z** Cordless String Trimmer

18V LXT Li-Ion Cordless String Trimmer

Li-ion Ah 6.0 | 5.0 | 3.0 | 1.5



Cutting Width	Trimmer Head: 260 mm (10-1/4")
No Load Speed (RPM)	7,800
Sound Power Level	88.5 dB(A)
Dimensions (L x W x H)	1,229 - 1,433 x 267 x 186 - 257 mm (48-1/2 - 56-1/2" x 10-1/2" x 7-3/8 - 10-1/8")
Max Run Time (min)	with BL1830B: 45
Net weight	2.8 - 3.1 kg (6.2 - 6.9 lbs)

18V



Safety Goggles, Shoulder Belt, Nylon Cutting Head, Nylon Cord, Battery, Fast Charger  
Z: Battery and Charger are sold separately

**UR100DWA / DZ** Cordless Grass Trimmer

Compact size is ideal for trimming and precise edging

Li-ion Ah 5.0 | 4.0 | 2.0 | 1.5



Cutting Width	Nylon Cutting Head: 260 mm (10") Plastic Blade: 230 mm (9")
No Load Speed (RPM)	10,000
Spindle Size	M8 x 1.25 RH
Dimensions (L x W x H)	835 - 1,195 x 267 x 210 - 315
Net weight	1.9 - 2.1 kg (4.3 - 4.6 lbs.)

12Vmax



Safety Goggles, Shoulder Belt, Nylon Cutting Head, Nylon Cord, Plastic Blade, Accessory Bag, Hex Wrench,  
Battery, Charger, DZ: Battery and Charger are sold separately

**UR3000** 300mm (11-3/4") String Trimmer

Lightweight AC string trimmers for do-it-yourselfers



Continuous Rating Input	450W
Cutting Width	300 mm (11-3/4")
No Load Speed (RPM)	9,000
Sound Power Level	96 dB(A)
Dimensions (L x W x H)	1,016 - 1,256 x 301 x 262 mm (40 - 49-1/2" x 11-7/8" x 10-3/8")
Net Weight	2.6 kg (5.7 lbs)
Power Supply Cord	10m



Extension Cord with Lock, Shoulder Strap, Safety Goggles, Nylon Cord

**LM004JZ** 530mm (21") Cordless Lawn Mower

3 cutting modes (Normal/ Soft no-load/ Noise reduction)

Li-ion Ah 10.0 | 4.0



Cutting Width	534 mm (21")
Cutting Height	20 - 100 mm (13/16 - 3-15/16")
Grass Box Capacity	70 L
No Load Speed (RPM)	2,300 - 2,800
Propelling speed	1.5 - 6.5 km/h/39
Wheel diameter	230 / 230 mm (9 / 9")
Dimensions (L x W x H)	1,740 - 1,810 x 595 x 970 - 1,080 mm (68-1/2 - 71-1/4 x 23-1/2 x 38-1/4 - 42-1/2")
Net weight	31.5 - 34.6 kg (69.5 - 76.3 lbs.)

64Vmax



Blade, Mulching plug, Socket wrench, Rod, Discharge chute, Battery, Charger,  
Z: Battery and Charger are sold separately



**BL64100**  
Powerful Li-Ion battery with 564.48Wh energy capacity

**Greater Power Performance**

BL6440 (4.0Ah)  
BL64100 (10.0Ah)  
Battery

DC64WA  
Charger

**64Vmax**



photo: LM004J

Continuous run time  
Push-Drive / Self-propelled

**81/59 min**

Battery: BL64100 on a full battery charge

**LM002JM101** 530mm (21") Cordless Lawn Mower

High power cordless lawn mower powered by 64Vmax (57.6V) Li-Ion battery

Li-ion Ah 10.0 | 4.0



Cutting Width	534 mm (21")
Cutting Height	20 - 100 mm (13/16 - 3-15/16")
Grass Box Capacity	70 L
No Load Speed (RPM)	2,300 - 2,800
Actual Mowing Area	1,600 m <sup>2</sup>
Continuous Use (min.)	39
Vibration Level	2.5 m/s <sup>2</sup> or less
Dimensions (L x W x H)	1,710 - 1,800 x 585 x 985 - 1,115 mm (67-1/2 - 71 x 23 x 38-3/4 - 44")
Net weight	25.7 - 27.6 kg

64Vmax



Blade, Mulching Plug, Socket Wrench, Rod, Battery, Charger

**LM001JM101** 480mm (18-7/8") Cordless Lawn Mower

High power cordless lawn mower powered by 64Vmax (57.6V) Li-Ion battery

Li-ion Ah 10.0 | 4.0



Cutting Width	480 mm (18-7/8")
Cutting Height	20 - 100 mm (13/16 - 3-15/16")
Grass Box Capacity	62 L
No Load Speed (RPM)	2,500 - 3,200
Actual Mowing Area	1,400 m <sup>2</sup>
Continuous Use (min.)	34
Vibration Level	2.5 m/s <sup>2</sup> or less
Dimensions (L x W x H)	1,600 - 1,680 x 540 x 955 - 1,080 mm (63 - 66 x 21-1/4 x 37-1/2 - 42-1/2")
Net weight	24.4 - 26.1 kg

64Vmax



Blade, Mulching Plug, Socket Wrench, Rod, Battery, Charger





**LM001GZ 480mm (18-7/8") Cordless Lawn Mower**

40Vmax XGT BL Cordless 48 cm (18-7/8") Self-Propelled Lawn Mower

<b>Li-ion</b>	Ah	8.0	5.0	4.0	2.5	2.0
<b>Cutting Width</b>		480 mm (18-7/8")				
<b>Cutting Height</b>		20 - 100 mm (13/16 - 3-15/16")				
<b>Grass Box Capacity</b>		62 L				
<b>No Load Speed (RPM)</b>		2,500 - 3,200				
<b>Propelling speed</b>		1.5 - 5.0 km/h				
<b>Wheel diameter</b>		230 / 230 mm (9 / 9")				
<b>Dimensions (L x W x H)</b>		During operation: 1,670 - 1,745 x 550 x 965 - 1,075 mm (65-3/4 - 68-3/4 x 21-5/8 x 38 - 42-1/4")				
<b>Net weight</b>		28.0 - 33.0 kg (61.7 - 72.8 lbs.)				

**40Vmax** 1  
Blade, Mulching plug, Socket wrench, Rod, Discharge chute, Battery, Charger, Z: Battery and Charger are sold separately

**LM004GZ 430mm (17") Cordless Lawn Mower**

**New**

40Vmax XGT BL Cordless 43 cm (17") Lawn Mower

<b>Li-ion</b>	Ah	8.0	5.0	4.0	2.5	2.0
<b>Cutting Width</b>		430 mm (17")				
<b>Cutting Height</b>		20 - 75 mm (13/16 - 2-15/16")				
<b>Grass Box Capacity</b>		50 L				
<b>No Load Speed (RPM)</b>		3,800 min <sup>-1</sup>				
<b>Continuous use (approx.) on a full battery charge</b>		w/ BL4080F: 52 min				
<b>Wheel diameter</b>		140 / 165 mm				
<b>Dimensions (L x W x H)</b>		During operation: 1,390 - 1,440 x 460 x 990 - 1,020 mm				
<b>Net weight</b>		15.6 - 18.2 kg (34.4 - 40.1 lbs.)				

**40Vmax** 1  
Socket wrench, Blade, Mulching plug, Grass catcher, Battery, Charger, Z: Battery and Charger are sold separately

**LM003GZ 380mm (15") Cordless Lawn Mower**

**New**

40Vmax XGT BL Cordless 38 cm (15") Lawn Mower

<b>Li-ion</b>	Ah	8.0	5.0	4.0	2.5	2.0
<b>Cutting Width</b>		380 mm (15")				
<b>Cutting Height</b>		20 - 75 mm (13/16 - 2-15/16")				
<b>Grass Box Capacity</b>		40 L				
<b>No Load Speed (RPM)</b>		3,800 min <sup>-1</sup>				
<b>Continuous use (approx.) on a full battery charge</b>		w/ BL4080F: 49 min				
<b>Wheel diameter</b>		140 / 165 mm				
<b>Dimensions (L x W x H)</b>		During operation: 1,370 - 1,420 x 450 x 990 - 1,020 mm				
<b>Net weight</b>		14.9 - 17.3 kg (32.8 - 38.1 lbs.)				

**40Vmax** 1  
Socket wrench, Blade, Mulching plug, Grass catcher, Battery, Charger, Z: Battery and Charger are sold separately



**Powered by 40Vmax XGT Li-Ion battery**

**Continuous use\***  
LM003G (380mm) about **49 min**  
LM004G (430mm) about **52 min**

**Mowing area\***  
LM003G (380mm) about **780 m<sup>2</sup>**  
LM004G (430mm) about **830 m<sup>2</sup>**

\*on a full battery charge (with BL4080F)



**Grass level indicator**

**Warning lamp for Battery capacity, High temperature and Overload**

**Grass catcher capacity**  
LM003G **40L** | LM004G **50L**

Photo: LM004G

**Cutting, Collecting, Mulching\***

\*Mulching plug required.

**Easier cutting height adjustment**

**Higher mowing performance**  
The blade is designed to tilt down towards the front of the mower when attached, minimizing double-cutting to reduce the load on the machine for reduced energy consumption, better feeling of cutting and improved grass collecting performance.





**LM001CZ** 534mm (21") Battery Powered Lawn Mower

Mows 5,700 m<sup>2</sup> with PDC1200



Cutting Width	534 mm (21")
Cutting Height	20-100 mm (13/16"-3-15/16")
No Load Speed (RPM)	2,300-2,800
Propelling Speed	2.5-5.0 km/h
Actual Mowing Area	w/ PDC01, Self-Propelled: 1,700 m <sup>2</sup>
*PDC01 (BL1860B X4)	w/ PDC01, push-drive: 2,300 m <sup>2</sup>
	w/ PDC1200, Self-Propelled: 4,200 m <sup>2</sup>
	w/ PDC1200, push-drive: 5,700 m <sup>2</sup>
Continuous Use (min.)	w/ PDC01, Self-Propelled: 40
*PDC01 (BL1860B X4)	w/ PDC01, push-drive: 50
	w/ PDC1200, Self-Propelled: 100
	w/ PDC1200, push-drive: 130
Dimensions (L x W x H)	1,630-1,715 x 590 x 990-1,095 mm
Net weight	41.9-49.2 kg (92.4-108.5 lbs.)



Blade, Mulching plug, Side discharge mouth, Socket wrench, Rod

**DLM539Z** 534mm (21") Cordless Lawn Mower

18V X2 (36V) BL Brushless Cordless 53 cm (21") Lawn Mower



Li-ion Ah 6.0 5.0 3.0 1.5

Cutting Width	534 mm (21")
Cutting Height	20-100 mm (13/16"-3-15/16")
No Load Speed (RPM)	3,000
Propelling Speed	2.5-5.0 km/h
Actual Mowing Area	w/ BL1860B x2, Self-Propelled: 700 m <sup>2</sup>
	w/ BL1860B x2, Push-Drive: 800 m <sup>2</sup>
Continuous Use (min.)	w/ BL1860B x2, Self-Propelled: 22
	w/ BL1860B x2, Push-Drive: 25
Dimensions (L x W x H)	During Operation: 1,810-1,870 x 580 x 920 - 1,040 mm
Net weight	28.0-30.5 kg



Blade, Mulch Plug, Socket Wrench, Rod, Battery, Charger, Z: Battery and Charger are sold separately

**DLM538Z** 534mm (21") Cordless Lawn Mower

18V X2 (36V) BL Brushless Cordless 53 cm (21") Lawn Mower



Li-ion Ah 6.0 5.0 3.0 1.5

Cutting Width	534 mm (21")
Cutting Height	20-100 mm (13/16"-3-15/16")
No Load Speed (RPM)	3,000
Actual Mowing Area	w/ BL1860B x2, Push-Drive: 800 m <sup>2</sup>
Continuous Use (min.)	w/ BL1860B x2, Push-Drive: 25
Dimensions (L x W x H)	During Operation: 1,810-1,870 x 580 x 920 - 1,040 mm
Net weight	25.6-28.1 kg (56.4-61.9 lbs.)



Blade, Mulch Plug, Socket Wrench, Rod, Battery, Charger, Z: Battery and Charger are sold separately

**DLM533Z** 534mm (21") Cordless Lawn Mower

18V X2 (36V) LXT BL Cordless 53 cm (21") Self-Propelled Lawn Mower



Li-ion Ah 6.0 5.0 3.0 1.5

Cutting Width	534 mm (21")
Cutting Height	20-100 mm (13/16"-3-15/16")
No Load Speed (RPM)	2,300-2,800
Dimensions (L x W x H)	1,655-1,740 x 590 x 990-1,100 mm (65"-68-1/2" x 23-1/4" x 39"-43-1/4")
Net weight	42.8-46.7 kg (94.4-103 lbs.)



Blade, Mulch plug, Socket Wrench, Rod, Battery, Charger, Z: Battery and Charger are sold separately

**DLM532Z / DLM530Z** 534mm (21") Cordless Lawn Mower

18V X2 LXT BL Brushless Cordless Self-Propelled Lawn Mower (DLM532 only)



Li-ion Ah 6.0 5.0 3.0 1.5

Cutting Width	534 mm (21")
Cutting Height	20-100 mm (13/16"-3-15/16")
No Load Speed (RPM)	2,300-2,800
Dimensions (L x W x H)	1,630-1,715 x 590 x 990-1,190 mm (64"-67-1/2" x 23-1/4" x 39"-46-3/4")
Net weight	DLM530Z: 35.5-39.3 kg (78.3-86.6 lbs.)
	DLM532Z: 39.0-42.8 kg (86.0-94.4 lbs.)



Blade, Mulch plug, Side Discharge Mouth, Socket Wrench, Rod, Battery, Charger, Z: Battery and Charger are sold separately

**DLM481Z** 480mm (18-7/8") Cordless Lawn Mower

18V X2 (36V) BL Brushless Cordless 48 cm (18-7/8") Lawn Mower



Li-ion Ah 6.0 5.0 3.0 1.5

Cutting Width	480 mm (18-7/8")
Cutting Height	20-100 mm (13/16"-3-15/16")
No Load Speed (RPM)	3,100
Propelling Speed	2.5-5.0 km/h
Actual Mowing Area	w/ BL1860B x2, Self-Propelled: 650 m <sup>2</sup>
	w/ BL1860B x2, Push-Drive: 800 m <sup>2</sup>
Continuous Use (min.)	w/ BL1860B x2, Self-Propelled: 23
	w/ BL1860B x2, Push-Drive: 28
Dimensions (L x W x H)	During Operation: 1,690-1,740 x 530 x 930 - 1,060 mm
Net weight	27.1-29.3 kg



Blade, Mulch Plug, Socket Wrench, Rod, Battery, Charger, Z: Battery and Charger are sold separately

**DLM480Z** 480mm (18-7/8") Cordless Lawn Mower

18V X2 (36V) BL Brushless Cordless 48 cm (18-7/8") Lawn Mower



Li-ion Ah 6.0 5.0 3.0 1.5

Cutting Width	480 mm (18-7/8")
Cutting Height	20-100 mm (13/16"-3-15/16")
No Load Speed (RPM)	3,100
Actual Mowing Area	w/ BL1860B x2, Push-Drive: 800 m <sup>2</sup>
Continuous Use (min.)	w/ BL1860B x2, Push-Drive: 28
Dimensions (L x W x H)	During Operation: 1,690-1,740 x 530 x 930 - 1,060 mm
Net weight	24.5-26.8 kg (54.0-59.1 lbs.)



Blade, Mulch Plug, Socket Wrench, Rod, Battery, Charger, Z: Battery and Charger are sold separately

**DLM462Z** 460mm (18") Cordless Lawn Mower

18V X2 LXT BL Brushless Cordless 46 cm (18") Self-Propelled Lawn Mower



Li-ion Ah 6.0 5.0 3.0 1.5

Cutting Width	460 mm (18")
Cutting Height	20-100 mm (13/16"-3-15/16")
No Load Speed (RPM)	2,500-3,300
Propelling speed	2.5-5.0 km/h
Dimensions (L x W x H)	1,610-1,690 x 535 x 980-1,095 mm (63-1/2"-66-1/2" x 21"x38-1/2"-43")
Net weight	35.3-39.0 kg (77.8-86.0 lbs.)



Blade, Mulch plug, Socket Wrench, Rod, Battery, Charger, Z: Battery and Charger are sold separately



**DLM460Z 460mm (18") Cordless Lawn Mower**

Brushless Cordless 46 cm (18") 3-in-1 Mower

Li-ion Ah 6.0 | 5.0 | 3.0 | 1.5



Blade Type	2 Tooth
Hole Diameter	10.0 mm (3/8")
Cutting Width	460 mm (18")
Cutting Height	20-75 mm (13/16"-2-5/16")
No Load Speed (RPM)	2,500 - 3,300
Recommended mowing area	w/ BL1860B x2: 800 - 1,600 m <sup>2</sup>
Continuous Use (min.)	w/ BL1860B / BL1850B / BL1840B / BL1830B / BL1820B / BL1815N x21 / 18/14/10/8/6
Sound Power Level	91 dB(A)
Dimensions (L x W x H)	1,319-1,518x532x
Net weight	25.3-27.6 kg (55.8-60.8 lbs.)

18V x2



Blade, Socket Wrench, Battery, Fast Charger, Z: Battery and Charger are sold separately

**DLM382CF2 / Z 380mm (15") Cordless Lawn Mower**

2-in-1 Mower

Li-ion Ah 6.0 | 5.0 | 3.0 | 1.5



DLM382CF2



DC18SH: Two Part Multi Slow Charge

Cutting Width	380 mm (15")
Cutting Height	20 - 75 mm (13/16" - 2-15/16")
No Load Speed (RPM)	3,700
Dimensions (L x W x H)	1,380-1,410x450x 985-1,005 mm (54-1/4"-55-1/2"x17-3/4"x38-3/4"-39-1/2")
Net weight	16.2 - 16.9 kg (35.7 - 37.3 lbs.)

18V x2



Blade, Wrench, Battery, Charger, Z: Battery and Charger are sold separately

**DLM230Z 230mm (9") Cordless Lawn Mower**

18V LXT Cordless 23 cm (9") 2-in-1 Lawn Mower

Li-ion 6.0 | 5.0 | 3.0 | 1.5



Cutting Width	230 mm (9")
Cutting Height	10 - 55 mm
Grass Box Capacity	20 L
No Load Speed (RPM)	7,000
Actual Mowing Area	w/ BL1830B: 90 m <sup>2</sup>
Continuous Use (min.)	w/ BL1830B: 6 min
Wheel Diameter	130 / 55 mm
Dimensions (L x W x H)	860 - 1,105 x 256 x 680 - 920 mm, When Stored (w/o Grass Box): 264 x 363 x 780 mm
Net weight	8.6 - 8.9 kg

18V



Blade, Hex wrench, Rod, Battery, Charger, Z: Battery and Charger are sold separately

**ELM4620 460mm (18-1/8") Electric Lawn Mower**

1,800N 4-in-1 Electric Mower



Continuous rating input	1,800W
Cutting Width	460 mm (18-1/8")
Cutting Height	20-75mm(13/16"-2-15/16")
No Load Speed (RPM)	2,950
Recommended mowing area up to	800 m <sup>2</sup>



Blade, Wrench, Mulch Plug



**ELM4121 410mm (16-1/8") Electric Lawn Mower**

Stays upright for easy maintenance and cleaning



Continuous rating input	1,600W
Cutting Width	410 mm (16-1/8")
Cutting Height	20-75mm(13/16"-2-15/16")
No Load Speed (RPM)	3,400
Recommended mowing area up to	600 m <sup>2</sup>



Blade, Wrench, Mulch Plug, Side Discharge Mouth

**ELM3720 370mm (14-1/2") Electric Lawn Mower**

Stays upright for easy maintenance and cleaning



Continuous rating input	1,400W
Cutting Width	370 mm (14-1/2")
Cutting Height	20-55mm(13/16"-2-3/16")
No Load Speed (RPM)	3,400
Recommended mowing area up to	500 m <sup>2</sup>



Blade, Wrench



**ELM3320 330mm (13") Electric Lawn Mower**

Stays upright for easy maintenance and cleaning



Continuous rating input	1,200W
Cutting Width	330 mm (13")
Cutting Height	20-55mm(13/16"-23/16")
No Load Speed (RPM)	3,400
Recommended mowing area up to	400 m <sup>2</sup>



Blade, Wrench

**UV001GZ Cordless Scarifier**

New

40Vmax XGT BL Cordless 380mm (15") Scarifier

Li-ion Ah 8.0 | 5.0 | 4.0 | 2.5 | 2.0



Cutting width	380 mm (15")
Working depth	-12 mm (-15/32") to 5 mm (+3/16")
Continuous run time on full battery charge	w/ BL4080F x2, Vertical cutter: 38 min Thatching blade: 41 min
Actual mowing area on full battery charge	w/ BL4080F x2, Vertical cutter: 500 m <sup>2</sup> Thatching blade: 510 m <sup>2</sup>
No load speed (RPM)	3,200
Grass catcher capacity	50 L
Dimensions (L x W x H)	1,020-1,240 x 680 x 915-1,155 mm
Net weight	18.7-23.8 kg (41.2-52.5 lbs.)



Vertical cutter, Thatching blade, Socket wrench, Grass catcher, Battery, Charger, Z: Battery and Charger are sold separately

**Healthy Lawn Growth and Maintenance with Aeration & Thatching**

Photo: UV001G

**Vertical cutter**

**Aeration applications**

Able to perform both thatching and vertical cutting to cut through runners and roots

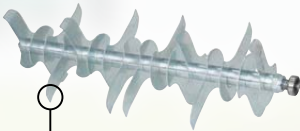

**Highly durable vertical cutter**

- Blunt angled blade tip slows blade wear to minimize the reduction in working depth.
- The slow wear reduces blade change frequency and running cost.

**Low vibration**

The blades of Vertical cutter are arranged symmetrically about the left-right center line of the rotary blade shaft to provide balanced rotation for reduced vibration.



**Actual mowing area on full battery charge**

With two BL4080F batteries

Vertical cutter Working depth: - 4 mm	Thatching blade Working depth: 0 mm
<b>500 m<sup>2</sup></b>	<b>510 m<sup>2</sup></b>

**Vertical cutting**

Effect obtained at different working depth settings

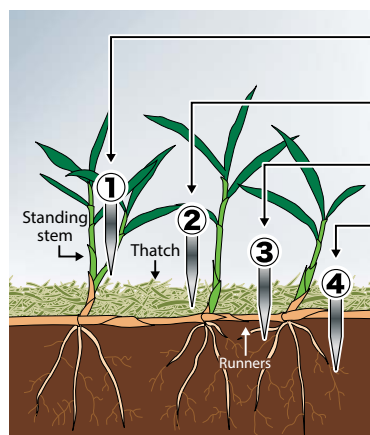

- Cutting through laterally growing lawn grasses for better looking lawn
- Removing layers of lawn clippings, generated moss, etc.
- Cutting through runners and roots for healthy growth of lawn
- Loosening compacted hard surface layer of soil

**18 stage (in 1mm increments)**

**Dial style working depth adjustment**  
Fine adjustment of working depth can be made by operating a dial, allowing for adjustment of working depth to suit the environment for lawn growth and wear of blade.

**Thatching blade**



**For thatching only**  
For removing deposited lawn clippings, generated moss, etc.

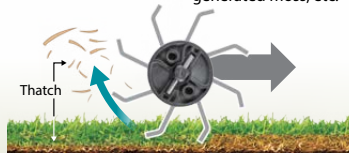

**Easy blade change**



Easy two bolt removal

**DUP361ZN**

33mm (1-5/16") Cordless Powered Pruning Shears

Smooth cutting similar to that of a hand pruner

Li-ion Ah 6.0 5.0 3.0 1.5



**Max Output Capacity**  
200W  
Max cutting : 33mm  
Max blade opening:  
54mm  
**Dimensions (L x W x H)**  
305x43x106mm  
(12"x1-11/16"x4-3/16")  
**Net weight**  
0.8 kg (1.8 lbs.)

18V x2

LXI XPT



Oil supply, Wrench set, Diamond file, Cord holder complete (for waist belt), Holster, Harness, Arm band, Tool bag, Shear blade (U), Battery, Fast Charger, Z: Battery and Charger are sold separately

**UP100DZ** Cordless Pruning Shears

New

Shear blade control is interlocked with Trigger for easier control of the blade

Li-ion Ah 5.0 4.0 2.0 1.5



**Capacity**  
Max cutting: 25 mm (1")  
**Vibration level**  
2.5 m/s<sup>2</sup> or less  
**Sound pressure level**  
70 dB(A) or less  
**Dimensions (L x W x H)**  
w/o Battery:  
259 x 53 x 98 mm  
(10-1/4 x 2-1/2 x 3-7/8")  
w/BL1016/BL1021B:  
285 x 64 x 98 mm  
(11-1/4 x 2-1/2 x 3-7/8")  
w/BL1041B:  
308 x 64 x 98 mm  
(12-1/8 x 2-1/2 x 3-7/8")  
**Net weight**  
0.89 - 1.1 kg  
(2.0 - 2.4 lbs.)

12Vmax

CX BL MOTOR XPT

Oil spray, Hex wrench, Socket wrench, Dressing stone, Holster, Battery, Charger, DZ: Battery and Charger are sold separately

Max cutting capacity  
**ø25mm**



**Adjustment of blade overlap when closed**

( by pressing and holding Blade opening angle adjustment button for 3 seconds or more when fully closed )



Lightweight  
**0.89 kg**  
with BL1016

**High cutting performance**



with BL1021B

**Work amount** on a full battery charge

When cutting ø15mm branches of Japanese cypress

**about 2,200 pcs**



Photo: UP100D

**DUS158Z** 15L Cordless Garden Sprayer

WetGuard; Excellent water-resistant performance

Li-ion Ah 6.0 5.0 3.0 1.5



**Max Pressure** 0.5 MPa  
**Chemical tank** 15 L  
**Hose Length** 1.7 m  
**Continuous Use (min.)**  
Y-shaped double nozzle:  
W/BL1830B: 120  
Wide angle herbicide nozzle: W/BL1830B: 180  
**Dimensions (L x W x H)**  
325 x 237 x 517 mm  
(12-3/4 x 9-3/8 x 20-3/8")  
**Net weight** 4.6 kg (10.1 lbs.)



18V

LXI XPT

Upright Double-Headed Nozzle, Wide-Angle Herbicide Nozzle, Shoulder Harness, Holder, Measure cup, Battery, Charger, Z: Battery and Charger are sold separately

**DUS108Z** 10L Cordless Garden Sprayer

WetGuard; Excellent water-resistant performance

Li-ion Ah 6.0 5.0 3.0 1.5



**Max Pressure** 0.5 MPa  
**Chemical tank** 10 L  
**Hose Length** 1.7 m  
**Continuous Use (min.)**  
Y-shaped double nozzle:  
W/BL1830B: 120  
Wide angle herbicide nozzle: W/BL1830B: 180  
**Dimensions (L x W x H)**  
325 x 237 x 439 mm  
(12-3/4 x 9-3/8 x 17-1/4")  
**Net weight** 4.6 kg (10.1 lbs.)



18V

LXI XPT

Upright Double-Headed Nozzle, Wide-Angle Herbicide Nozzle, Shoulder Harness, Holder, Measure cup, Battery, Charger, Z: Battery and Charger are sold separately



**DUS054Z** 5L Cordless Garden Sprayer

Two head nozzles for a wide range of spray

Li-ion Ah 6.0 5.0 3.0 1.5



**Max Pressure** 0.3 MPa (3 kgf/cm<sup>2</sup>)  
**Chemical tank** 5 L  
**Hose Length** 1.7 m  
**Continuous Use (min.)**  
Spray Single: w/  
BL1860B: 530 min  
**Dimensions (L x W x H)**  
340 x 183 x 360 mm  
(13-3/8 x 7-1/4 x 14-1/8")  
**Net weight** 2.1 kg (4.6 lbs.)



18V

LXI XPT

Shoulder Harness, Holder, Battery, Charger, Z: Battery and Charger are sold separately



**US053DZ 5L Cordless Garden Sprayer**

12Vmax CXT Li-Ion Cordless 5 L Garden Sprayer

Li-ion Ah 5.0 | 4.0 | 2.0 | 1.5

Max Pressure	0.3 Mpa (3 kgf/cm <sup>2</sup> )
Chemical tank	5 L
Hose Length	1.7 m
Continuous Use (min.)	Spray Single: w/ BL1041B :250
Dimensions (L x W x H)	340 x 183 x 335 mm (13-3/8 x 7-1/4 x 13-1/4")
Net weight	2.0 kg



12Vmax **CXT XPT**

Shoulder Harness, Holder, Battery, Charger, DZ: Battery and Charger are sold separately

**DVF154Z 15L Cordless Garden Sprayer**

Environmentally-friendly with no emission and extremely low noise

Li-ion Ah 6.0 | 5.0 | 3.0 | 1.5

Max pressure	0.3Mpa (3kgf/cm <sup>2</sup> )
Chemical tank	15L
Dimensions (L x W x H)	345x235x525mm (13-5/8"x9-1/4"x20-3/4")
Net weight	4.1 - 4.5kg (9.1 - 9.7lbs)



18V **LXT**

Y-shaped Double Nozzle, Wide Angle Nozzle, Spray Pipe Holder, Shoulder Harness, Z: Battery and Charger are sold separately

**DVF104Z 10L Cordless Garden Sprayer**

Environmentally-friendly with no emission and extremely low noise

Li-ion Ah 6.0 | 5.0 | 3.0 | 1.5

Max pressure	0.3Mpa (3kgf/cm <sup>2</sup> )
Chemical tank	10L
Dimensions (L x W x H)	315x225x415mm (12-3/8"x8-7/8"x16-3/8")
Net weight	3.8 - 4.1kg (8.4 - 9.1lbs)



18V **LXT**

Y-shaped Double Nozzle, Wide Angle Nozzle, Spray Pipe Holder, Shoulder Harness, Z: Battery and Charger are sold separately

**PM001GT202(PT2) / GZ01 Cordless Backpack Mist Blower**

**New**

40Vmax XGT BL Cordless Backpack Mist Blower

Li-ion Ah 8.0 | 5.0 | 4.0

Chemical tank capacity	15.0 L (507 oz)
Max air volume	High/Med./Low: 14.3/11.0/9.0 m <sup>3</sup> /min
Max air velocity	High/Med./Low: 64.0/52.0/42.0 m/s
Avg. air velocity	High/Med./Low: 53.0/43.0/34.0 m/s
Vibration level	84.5 dB (A)
Sound power level	103.3 dB (A)
Continuous Use (min.)	w/ BL4080F-x2 High: 20 w/o Nozzle: 12-5/8 x 23-5/8 x 27-1/4"
Dimensions (L x W x H)	320 x 600 x 690 mm (12-5/8 x 23-5/8 x 27-1/4")
Net weight	13.2 - 15.7 kg (29.1 - 34.6 lbs.)



40Vmax

Diffusion cover, Wrench, Nozzle, Battery, Charger, Z: Battery and Charger are sold separately



Photo: PM001G

**Solution tank capacity**  
**15 L**

**Powered by 40Vmax XGT Li-Ion battery (two in parallel or one)**

**Average particle size**  
High spraying speed mode  
**50/150 μm**  
ULV nozzle/Standard nozzle

**Switch Interlocking Valve**  
The opening/closing operation of the solution supply valve is interlocked with the switch trigger to suppress dripping of solution.

**Max spray distance: 14m**



**A variety of front covers**

**Diffusion cover**  
You can diffuse the mist by attaching the diffusion cover to the end nozzle

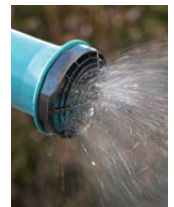

**Deflector set (Option)**  
You can discharge the mist upward or downward by attaching the deflector to the end nozzle

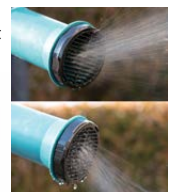

**DG001GZ02 Cordless Earth Auger**

Lightweight design for reduced operator fatigue

Li-ion Ah 8.0 | 5.0 | 4.0 | 2.5 | 2.0

Capacity	Sandy Soil: 200 mm Clay Soil: 150 mm
No Load Speed (RPM)	High / Low: 0 - 1,500 / 0 - 400
Max Fastening Torque	High: 55 N-m (487 in.lbs.) Low: 136 N-m (1,210 in.lbs.)
Dimensions (L x W x H)	836 x 605 x 199 mm (33 x 23-3/4 x 7-7/8")
Net weight	7.2 - 8.1 kg (15.9 - 17.9 lbs.)



40Vmax



**XGT BL ADT XPT**

Chuck Key, Hex Wrench, Adapter, Battery, Charger, Z: Battery and Charger are sold separately

**DDG460ZX4 Cordless Earth Auger**

Battery powered and powerful

Li-ion Ah 6.0 | 5.0 | 3.0 | 1.5

Capacity	Sandy Soil: 200 mm Clay Soil: 150 mm
No Load Speed (RPM)	High / Low: 0 - 1,400 / 0 - 350
Max Fastening Torque	High: 48 N-m (430 in.lbs.) Low: 136 N-m (1,210 in.lbs.)
Vibration Level	2.5 m/s <sup>2</sup> or less
Sound Pressure Level	85 dB(A)
Sound Power Level	96 dB(A)
Dimensions (L x W x H)	840 x 607 x 223 mm (33 x 23-7/8 x 8-3/4")
Net weight	7.3 - 8.2 kg (16.1 - 18.1 lbs.)



18V x2



**LXT BL ADT XPT**

Chuck Key, Hex Wrench, Adapter, Battery, Charger, Z: Battery and Charger are sold separately



# CORDLESS TOOLS FOR INDUSTRY

## Screwdriver, Angle Screwdriver

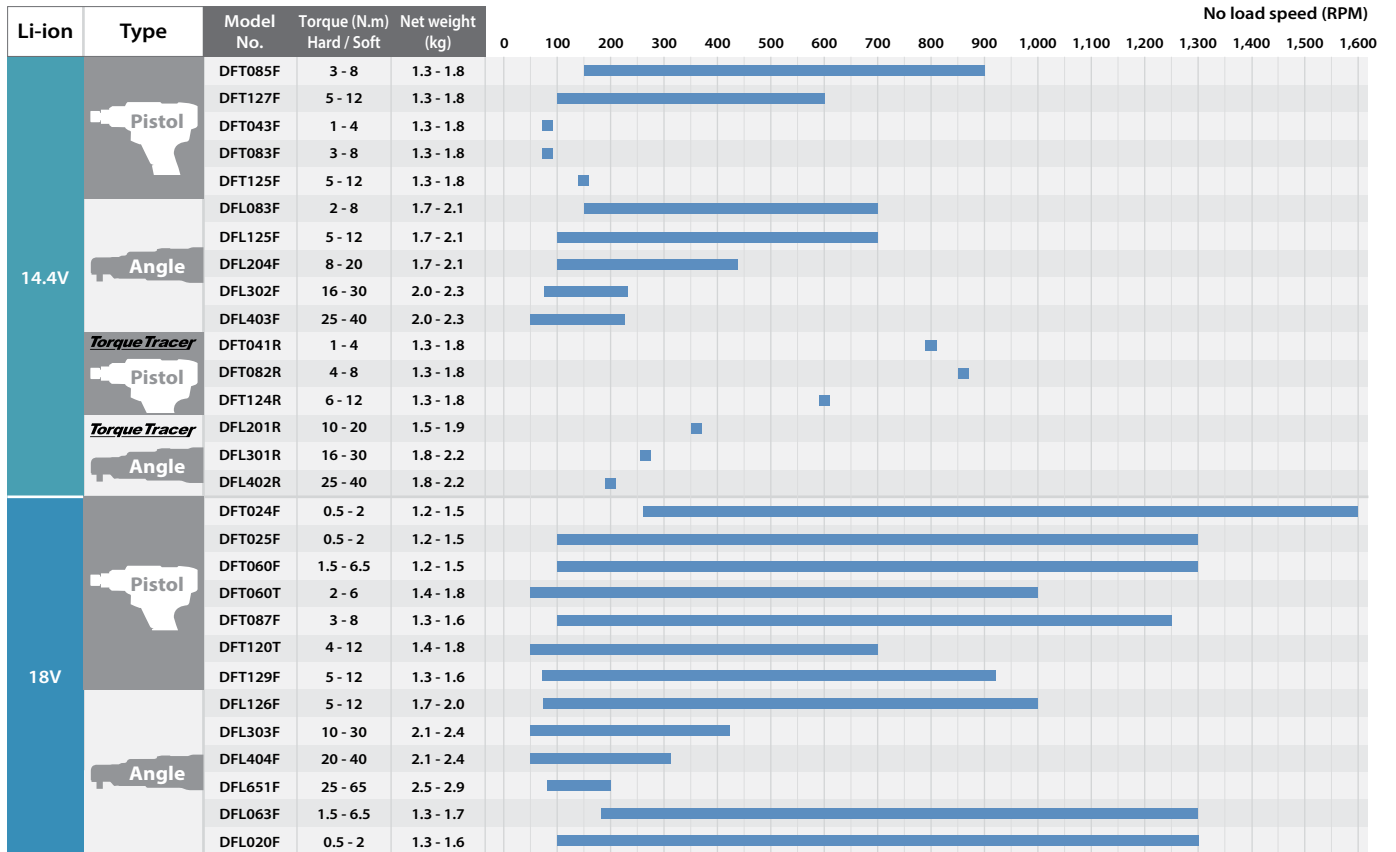

## Impact Driver, Impact Wrench

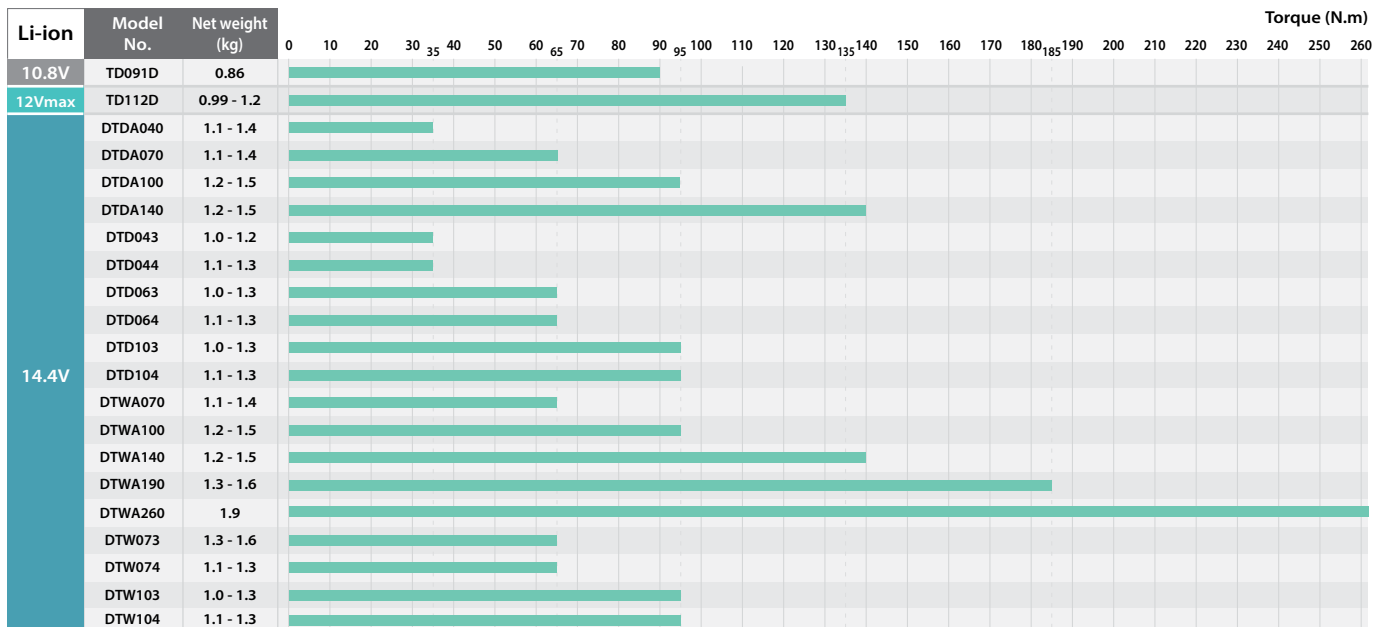



## Battery & Charger Time Reference Chart (in Minutes)

14.4V Lithium-ion		DC18RC (195586-8)	DC18SD (194534-4)	DC18SE (Automotive) (194621-9)	DC24SC (194164-1)
6.0 Ah	BL1460A (632G42-4)	9.6V,12V 14.4V,18V	9.6V,12V 14.4V,18V	9.6V,12V 14.4V,18V	9.6V,12V 14.4V,18V,24V
	<b>Fast Charging</b>	<b>55 min.</b>	<b>130 min.</b>	<b>130 min.</b>	<b>75 min.</b>
4.0 Ah	BL1440 (196388-5)	<b>36 min.</b>	<b>90 min.</b>	<b>90 min.</b>	-
3.0 Ah	BL1430A (194359-6)	<b>22 min.</b>	<b>60 min.</b>	<b>60 min.</b>	-
3.0 Ah	BL1430B (197615-3)	<b>22 min.</b>	<b>60 min.</b>	<b>60 min.</b>	-
1.5 Ah	BL1415NA (196280-5)	<b>15 min.</b>	<b>30 min.</b>	<b>30 min.</b>	<b>20 min.</b>

## MAKSTAR

24V Ni-MH		14.4V Ni-MH		12V Ni-MH		9.6V Ni-MH		DC18RC (195586-8)	DC18SD (194534-4)	DC18SE (Automotive) (194621-9)	DC24WA	DC24SC (194164-1)
3.1 Ah	BH2433 (193739-3)	BH1433 (193354-3)	BH1233C (A-37655)	-	-	-	-	9.6V,12V 14.4V,18V	9.6V,12V 14.4V,18V	9.6V,12V 14.4V,18V	9.6V,12V,14.4V 18V,24V	9.6V,12V,14.4V 18V,24V
								<b>22</b>	<b>70</b>	<b>70</b>	<b>70</b>	<b>30</b>
								BH9033/A : 30min.			BH2433 : 90min.	BH2433 : 60min. DC24SC-BH2433 : 50min.
1.8 Ah	BH2420 (193736-9)	-	BH1220C (193928-0)	*BH9020A (193590-1)	BH9020 (193631-3)							
								<b>15</b>	<b>40</b>	<b>40</b>	<b>40</b>	<b>20</b>
								BH9020/A : 20min.			BH2420 : 55min.	BH2420 : 30min.

( ) Part No. \* Power Display Type

### DFT045FNZ Cordless Screwdriver

14.4V LXT BL Brushless Programmable Cordless 2 N-m (18 In.Lbs.) Screwdriver

Li-ion Ah 6.0 | 5.0 | 3.0 | 1.5



Driving Shank (Hex)	6.35 mm (1/4")
No Load Speed (RPM)	400 - 1,300 / 150 - 900
Fastening Torque	Hard / Soft: 1-4 / 1-4 N-m (9-35 / 9-35 in.lbs.)
Sound Pressure Level	70 dB(A) or less
Dimensions (L x W x H)	159x72x232 mm (6-1/4"x2-13/16"x9-1/8")
Net weight	1.1 - 1.3 kg (2.4 - 2.9 lbs.)

14.4V



USB Cable, Z: Battery and Charger are sold separately

### DFT025FNZ Cordless Screwdriver

18V LXT BL Brushless Programmable Cordless Screwdriver

Li-ion Ah 6.0 | 5.0 | 3.0 | 1.5



Driving Shank (Hex)	5 mm (1/4")
No Load Speed (RPM)	100 - 1,300
Fastening Torque	Hard / Soft: 0.5 - 2 / 0.5 - 2 N-m w/ BL1830B / BL1840B / BL1850B / BL1860B: 161 x 75 x 258 mm (6-3/8 x 2-15/16 x 10-1/8")
Dimensions (L x W x H)	
Net weight	1.2 - 1.5 kg (2.6 - 3.3 lbs.)

18V



Z: Battery and Charger are sold separately

**DFT060FNZ** Cordless Screwdriver

18V LXT BL Brushless Programmable Cordless Screwdriver

Li-ion Ah 6.0 5.0 3.0 1.5



Driving Shank (Hex)	6.35 mm (1/4")
No Load Speed (RPM)	100 - 1,300
Fastening Torque	Hard / Soft: 1.5 - 6.5 / 1.5 - 6.5 N·m w/ BL1830B / BL1840B / BL1850B / BL1860B: 161 x 75 x 258 mm (6-3/8 x 2-15/16 x 10-1/8")
Dimensions (L x W x H)	
Net weight	1.2 - 1.5 kg (2.6 - 3.3 lbs.)



Z: Battery and Charger are sold separately

**DFT060TNZ / DFT120TNZ** Cordless Screwdriver

18V LXT BL Brushless Programmable Cordless Screwdriver

Li-ion Ah 6.0 5.0 3.0 1.5



No Load Speed (RPM)	DFT060TNZ: 50 - 1,400 DFT120TNZ: 50 - 700
Fastening Torque	Hard / Soft: 2 - 6 N·m DFT120TNZ: 4 - 12 N·m w/ BL1830B / BL1840B / BL1850B / BL1860B: 209 x 72 x 249 mm (6-3/8 x 2-15/16 x 10-1/8")
Dimensions (L x W x H)	
Net weight	1.3 - 1.6 kg



Z: Battery and Charger are sold separately



**DFT085FNZ / DFT127FNZ** Cordless Screwdriver

14.4V LXT BL Brushless Programmable Cordless Screwdriver

Li-ion Ah 6.0 5.0 3.0 1.5



Driving Shank (Hex)	6.35 mm (1/4")
No Load Speed (RPM)	150 - 900 / 100 - 600
Fastening Torque	Hard / Soft: DFT085FNZ: 3 - 8 / 3 - 8 N·m (27 - 71 / 27 - 71 in.lbs.) DFT127FNZ: 5 - 12 / 5 - 12 N·m (44 - 106 / 44 - 106 in.lbs.)
Sound Pressure Level	70 dB(A) or less
Dimensions (L x W x H)	190 x 72 x 237 mm (7-1/2" x 2-13/16" x 9-3/8")
Net weight	1.3 - 1.8 kg (2.8 - 3.9 lbs.)



USB Cable, Z: Battery and Charger are sold separately

**DFT087FNZ / DFT129FNZ** Cordless Screwdriver

18V LXT BL Brushless Programmable Cordless Screwdriver

Li-ion Ah 6.0 5.0 3.0 1.5



Driving Shank (Hex)	6.35 mm (1/4")
No Load Speed (RPM)	100 - 1,250 / 70 - 900
Fastening Torque	Hard / Soft: DFT087FNZ: 3 - 8 / 3 - 8 N·m (27 - 71 / 27 - 71 in.lbs.) DFT129FNZ: 5 - 12 / 5 - 12 N·m (44 - 106 / 44 - 106 in.lbs.)
Sound Pressure Level	71 dB(A)
Dimensions (L x W x H)	179 x 75 x 230 mm (7 x 2-15/16 x 9")
Net weight	1.3 - 1.6 kg (2.9 - 3.5 lbs.)



Z: Battery and Charger are sold separately

## Li-ion 14.4V Cordless Screw Driver

### Auto-stop system and on-off switch with delayed restarter

Prevent defective on production and keep quality



When a battery is discharged, indication lamp and beeper start warning and then the motor stops automatically

The tool remains still for 1 second after fastening is completed.

### Indication Lamp & Beeper

Warn and prevent errors on production.



### High Power Motor

• Equipped with high power motor  
• Easy to change an armature and carbon brush for high maintenance performance

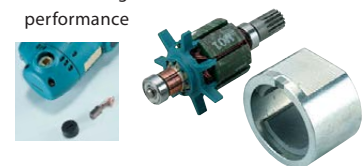

- Rigid Body
- Optimum Charging System
- Ergonomic Grip
- High accuracy
- LED job light
- ON-OFF Switch with delayed restarter and soft start function
- Torque indication plate





**DFL302FZ** Cordless Angle Screwdriver

14.4V LXT BL Brushless Cordless Angle Screwdriver

Li-ion Ah 6.0 | 5.0 | 3.0 | 1.5



Driving Shank (Square)	9.5 mm (3/8")
No Load Speed (RPM)	70 - 230 / 50 - 220
Fastening Torque	Hard / Soft:
	16 - 30 / 16 - 30 N·m (142 - 266 / 142 - 266 in.lbs.)
Dimensions (L x W x H)	518x74x98 mm (20-3/8"x2-15/16"x3-7/8")
Head Height	35 mm (1-3/8")
Center Height	18.5 mm (3/4")
Net weight	2.0 - 2.3 kg (4.4 - 5.2 lbs.)

14.4V



USB Cable, Z: Battery and Charger are sold separately

**DFL402FZ** Cordless Angle Screwdriver

14.4V LXT BL Brushless Cordless Angle Screwdriver

Li-ion Ah 6.0 | 5.0 | 3.0 | 1.5



Driving Shank (Square)	9.5 mm (3/8")
No Load Speed (RPM)	260 / 200
Fastening Torque	Hard / Soft:
	25 - 40 / 25 - 40 N·m (221 - 354 / 221 - 354 in.lbs.)
Sound Pressure Level	74 dB(A) / 72 dB(A)
Dimensions (L x W x H)	477x72x98 mm (18-3/4"x2-13/16"x3-7/8")
Net weight	1.7 - 2.1 kg (3.8 - 4.6 lbs.)

14.4V



Z: Battery and Charger are sold separately

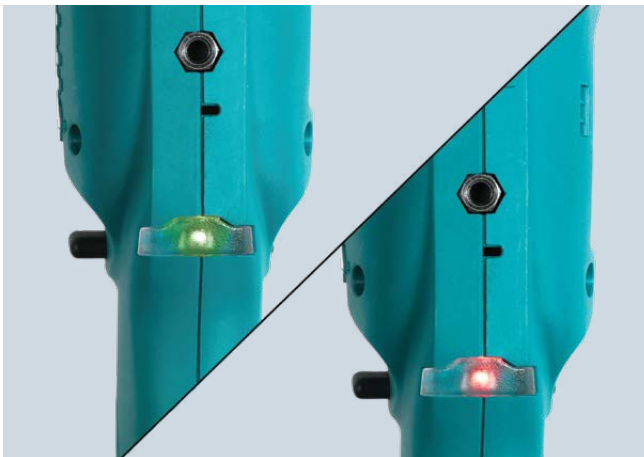

**DFL650FZ** Cordless Angle Screwdriver

18V LXT BL Brushless Cordless 65 N·m (580 in.lbs.) Angle Screwdriver

Li-ion Ah 6.0 | 5.0 | 3.0 | 1.5



Driving Shank (Square)	9.5 / 12.7 mm (3/8 / 1/2")
No Load Speed (RPM)	80 - 200
Fastening Torque	Hard / Soft:
	25 - 65 / 25 - 65 N·m (220 - 580 / 220 - 580 in.lbs.)
Vibration Level	Screwdriving without Impact: 2.5 m/s <sup>2</sup> or less
Sound Pressure Level	72 dB(A)
Dimensions (L x W x H)	600x75x116 mm (23-5/8"x2-15/16"x4-9/16")
Net weight	2.4 - 2.9 kg (5.3 - 6.3 lbs.)

18V



Torque Adjustment Tool, USB Cable, Z: Battery and Charger are sold separately

# Touch&Set

Easy to set by smart device

4 stage programmable speed can be set by touching with NFC (Near Field Communication) function of Android.

Near Field Communication  
**NFC**

Photo: DFL650F





**DTWA100Z 9.5mm (3/8") Cordless Impact Wrench**

14.4V LXT BL Brushless Cordless 3/8" (9.5 mm) 95 N-m (70 ft.lbs.) Impact Wrench

Li-ion Ah 6.0 | 5.0 | 3.0 | 1.5



<b>Square Drive Capacity</b>	9.5 mm (3/8") Standard Bolt: M5 - M12 (3/16" - 1/2") High Strength Bolt: M5 - M10 (3/16" - 3/8")
<b>No Load Speed (RPM)</b>	0 - 2,700
<b>Impacts Per Minute (IPM)</b>	0 - 3,300
<b>Max Fastening Torque</b>	95 N-m (70 ft.lbs.)
<b>Dimensions (L x W x H)</b>	158x74x256 mm
<b>Net weight</b>	1.2 - 1.5 kg (2.7 - 3.3 lbs.)

14.4V



Z: Battery and Charger are sold separately

**DTWA140Z 12.7mm (1/2") Cordless Impact Wrench**

14.4V LXT BL Brushless Cordless 12.7 mm (1/2") 140 N-m (103 ft.lbs.) Impact Wrench

Li-ion Ah 6.0 | 5.0 | 3.0 | 1.5



<b>Square Drive Capacity</b>	12.7 mm (1/2") Standard Bolt: M6 - M16 (1/4" - 5/8") High Strength Bolt: M6 - M12 (1/4" - 1/2")
<b>No Load Speed (RPM)</b>	0 - 2,700
<b>Impacts Per Minute (IPM)</b>	0 - 3,300
<b>Max Fastening Torque</b>	140 N-m (103 ft.lbs.)
<b>Dimensions (L x W x H)</b>	158x74x256 mm
<b>Net weight</b>	1.2 - 1.5 kg (2.7 - 3.3 lbs.)

14.4V



Z: Battery and Charger are sold separately

**DTWA190Z 12.7mm (1/2") Cordless Impact Wrench**

14.4V LXT BL Brushless Cordless 12.7 mm (1/2") 185 N-m (136 ft.lbs.) Impact Wrench

Li-ion Ah 6.0 | 5.0 | 3.0 | 1.5



<b>Square Drive Capacity</b>	12.7 mm (1/2") Standard Bolt: M8 - M16 (5/16" - 5/8") High Strength Bolt: M8 - M14 (5/16" - 9/16")
<b>No Load Speed (RPM)</b>	0 - 2,600
<b>Impacts Per Minute (IPM)</b>	0 - 3,000
<b>Max Fastening Torque</b>	185 N-m (136 ft.lbs.)
<b>Dimensions (L x W x H)</b>	158x74x256 mm
<b>Net weight</b>	1.3 - 1.6 kg (2.9 - 3.5 lbs.)

14.4V



Z: Battery and Charger are sold separately

**DTWA260Z 12.7mm (1/2") Cordless Impact Wrench**

**New**

18V LXT BL Brushless Cordless 12.7 mm (1/2") 260 N-m Impact Wrench

Li-ion Ah 6.0 | 5.0 | 3.0 | 1.5



<b>Square Drive Capacity</b>	12.7 mm (1/2") Standard Bolt: M14 - M20 (9/16 - 3/4") High Strength Bolt: M10 - M16 (3/8 - 5/8")
<b>No Load Speed (RPM)</b>	0 - 2,800
<b>Impacts Per Minute (IPM)</b>	0 - 3,400
<b>Max Fastening Torque</b>	260 N-m (190 ft.lbs.)
<b>Dimensions (L x W x H)</b>	161 x 82 x 265 mm
<b>Net weight</b>	1.8 kg (4.0 lbs.)

18V



Z: Battery and Charger are sold separately

**Makita**  
**mt**

**PRODUCTS**



**M6500B 6.5mm (1/4") High Speed Drill**

Compact and lightweight for reduced operator fatigue

64



<b>Continuous Rating Input Capacity</b>	230W Steel: 6.5 mm (1/4") Wood: 9 mm (11/32")
<b>No Load Speed (RPM)</b>	0 - 4,500
<b>Sound Pressure Level</b>	72 dB(A)
<b>Dimensions (L x W x H)</b>	200x63x164 mm
<b>Net Weight</b>	(7-7/8"x2-1/2"x6-1/2") 0.92 kg (2.0 lbs)
<b>Power Supply Cord</b>	2.0 m (6.6 ft.)



Chuck Key, Chuck Key Holder, Depth Gauge, Cap

**M6001B 10mm (3/8") Drill**

Compact and lightweight for reduced operator fatigue

85



<b>Continuous Rating Input Capacity</b>	450W Steel: 10 mm (3/8") Wood: 25 mm (1")
<b>No Load Speed (RPM)</b>	0 - 3,000
<b>Sound Pressure Level</b>	77 dB(A)
<b>Dimensions (L x W x H)</b>	229x64x175 mm
<b>Net Weight</b>	(9"x2-1/2"x6-7/8") 1.3 kg (2.9 lbs)
<b>Power Supply Cord</b>	2.0 m (6.6 ft.)



Chuck Key

**M0600B 10mm (3/8") Drill**

Powerful 350 W motor for continuous operation

64



Continuous Rating Input	350W
Capacity	Steel: 10 mm (3/8") Wood: 20 mm (13/16")
No Load Speed (RPM)	0 - 3,000
Sound Pressure Level	77 dB(A)
Dimensions (L x W x H)	230x66x176 mm (9"x2-5/8"x6-15/16")
Net Weight	1.2 kg (2.6 lbs)
Power Supply Cord	2.0 m (6.6 ft)



Chuck Key, Chuck Key Holder

**M6600XB 165mm (6-1/2") Mixer**

Powerful 800 W motor for improved mixing performance

303



Continuous Rating Input	800W
Blade Diameter	165 mm (6-1/2")
No Load Speed (RPM)	0 - 700
Sound Pressure Level	85 dB(A)
Sound Power Level	96 dB(A)
Dimensions (L x W x H)	280x86x388 mm (11"x3-3/8"x15-1/4")
Net Weight	2.6 - 2.7 kg (5.7 - 5.9 lbs)
Power Supply Cord	2.0 m (6.6 ft)



Mixing Blade, Shaft, Top Grip, D-Handle, Wrenches

**M8103B 13mm (1/2") Hammer Drill**

High performance and durability at less expense

85



Continuous Rating Input	430W
Capacity	Concrete: 13 mm (1/2") Steel: 13 mm (1/2") Wood: 18 mm (11/16")
Blows Per Minute (BPM)	0 - 33,000
No Load Speed (RPM)	0 - 3,000
Sound Pressure Level	90 dB(A)
Sound Power Level	101 dB(A)
Dimensions (L x W x H)	255x72x193 mm (10"x2-13/16"x7-5/8")
Net Weight	1.8 kg (3.9 lbs)
Power Supply Cord	2.0 m (6.6 ft)



Side Handle, Depth Gauge, Chuck Key, Chuck Key Holder

**M8103KX2B 13mm (1/2") Hammer Drill**

Ergonomically designed handle with Soft grip

85



Continuous Rating Input	430W
Capacity	Concrete: 13 mm (1/2") Steel: 13 mm (1/2") Wood: 18 mm (11/16")
Blows Per Minute (BPM)	0 - 33,000
No Load Speed (RPM)	0 - 3,000
Sound Pressure Level	90 dB(A)
Sound Power Level	101 dB(A)
Dimensions (L x W x H)	255x72x193 mm (10"x2-13/16"x7-5/8")
Net Weight	1.8 kg (3.9 lbs)
Power Supply Cord	2.0 m (6.6 ft)



Side Handle, Depth Gauge, Chuck Key, Chuck Key Holder

**M0801B / M0801BX1 16mm (5/8") Hammer Drill**

High performance and durability at less expense

85



Continuous Rating Input	500W
Capacity	Concrete: 16 mm (5/8") Steel: 13 mm (1/2") Wood: 20 mm (13/16")
Blows Per Minute (BPM)	0 - 48,000
No Load Speed (RPM)	0 - 3,200
Sound Pressure Level	94 dB(A)
Sound Power Level	105 dB(A)
Dimensions (L x W x H)	261x69x195 mm (10-1/4"x2-3/4"x7-5/8")
Net Weight	1.7 kg (3.7 lbs)
Power Supply Cord	2.0 m (6.6 ft)



Side Grip, Chuck Key, Chuck Key Holder

**M8100B 16mm (5/8") Hammer Drill**

High performance and durability at less expense

85



Continuous Rating Input	710W
Capacity	Concrete: 16 mm (5/8") Steel: 13 mm (1/2") Wood: 30 mm (1-3/16")
Blows Per Minute (BPM)	0 - 48,000
No Load Speed (RPM)	0 - 3,200
Sound Pressure Level	98 dB(A)
Sound Power Level	109 dB(A)
Dimensions (L x W x H)	296x77x202 mm (11-5/8"x3"x8")
Net Weight	2.1 kg (4.6 lbs.)
Power Supply Cord	2.0 m (6.6 ft)



Chuck Key, Side Grip, Depth Gauge

**M8700B 22mm (7/8") Rotary Hammer**

Adapted for SDS-PLUS bits

459



Continuous Rating Input	710W
Capacity	Concrete: 22 mm (7/8") Core Bit: 54 mm (2-1/8") Diamond Core Bit (Dry Type): 65 mm (2-9/16") Steel: 13 mm (1/2") Wood: 32 mm (1-1/4")
Blows Per Minute (BPM)	0 - 4,350
No Load Speed (RPM)	0 - 1,100
Dimensions (L x W x H)	362x71x194mm (14-1/4"x2-13/16"x7-5/8")
Net Weight	2.5 - 2.9 kg (5.6 - 6.4 lbs)
Power Supply Cord	2.5 m (8.2 ft)

Tool does not come with bit



Depth gauge, Side grip

**M8701B 26mm (1") Combination Hammer**

Adapted for SDS-PLUS bits, 3 operation modes

459



Continuous Rating Input	800W
Capacity	Concrete: 26 mm (1") Core Bit: 68 mm (2-11/16") Diamond Core Bit (Dry Type): 80 mm (3-1/8") Steel: 13 mm (1/2") Wood: 32 mm (1-1/4")
Blows Per Minute (BPM)	0 - 4,500
No Load Speed (RPM)	0 - 1,200
Dimensions (L x W x H)	362x71x194mm (14-1/4"x2-13/16"x7-5/8")
Net Weight	2.7 - 3.1 kg (6.0 - 6.8 lbs)
Power Supply Cord	2.5 m (8.2 ft)

Tool does not come with bit



Side grip, Depth gauge



**M8600B 17mm (11/16") Demolition Hammer**

Satisfactory chipping performance

105



Continuous Rating Input	900W
Impact Energy	7.2 J
Blows Per Minute (BPM)	2,900
Sound Pressure Level	95 dB(A)
Sound Power Level	106 dB(A)
Dimensions (L x W x H)	406x99x232 mm (16"x3-7/8"x9-1/8")
Net Weight	5.4 kg (12 lbs)
Power Supply Cord	4.0 m (13.1 ft)



Bull Point, Side Grip, Bit Grease, Cleaning cloth

**M4100B 110mm (4-3/8") Cutter**

Redesigned base with grooved back surface for smoother operation

303



Continuous Rating Input	1,200W
Blade Diameter	110 mm (4-3/8")
Max Cutting Capacity	90°: 32 mm (1-1/4")
No Load Speed (RPM)	13,000
Sound Power Level	111 dB(A)
Dimensions (L x W x H)	227x209x166 mm (8-15/16"x8-1/4"x6-1/2")
Net Weight	2.9 kg (6.4 lbs)
Power Supply Cord	2.0 m (6.6 ft)



Wrench, Water supply fixture, Vinyl tube, Tube holder

**M2401B 355mm (14") Portable Cut-off**

Powerful cutting with high power motor

203



Continuous Rating Input	2,000W
Wheel Diameter	355 mm (14")
No Load Speed (RPM)	3,800
Sound Pressure Level	100 dB(A)
Sound Power Level	111 dB(A)
Dimensions (L x W x H)	500x280x620 mm (19-3/4"x11"x24-3/8")
Net Weight	13.7 kg (30.2 lbs.)
Power Supply Cord	2.5 m (8.2 ft.)



Abrasive cut-off wheel, Socket wrench



**M0900B 100mm (4") Angle Grinder**

Two action safety switch for minimizing sudden accidental lock-on

459



Continuous Rating Input	540W
Wheel Diameter	100 mm (4")
No Load Speed (RPM)	12,000
Dimensions (L x W x H)	251x118x97 mm (9-7/8"x4-5/8"x3-13/16")
Net Weight	1.6 kg (3.5 lbs)
Power Supply Cord	2.0 m (6.6 ft)

Tool does not come with depressed center wheel



Lock Nut Wrench

**M9506B 100mm (4") Angle Grinder**

720W series

459



Continuous Rating Input	720W
Wheel Diameter	100 mm (4")
No Load Speed (RPM)	11,000
Sound Pressure Level	86 dB(A)
Sound Power Level	97 dB(A)
Dimensions (L x W x H)	261x118x101 mm (10-1/4"x4-5/8"x4")
Net Weight	1.6 kg (3.5 lbs)
Power Supply Cord	2.0 m (6.6 ft)



Side Grip, Lock Nut Wrench

**M9512B 100mm (4") Angle Grinder**

High performance and durability at less expense

459



Continuous Rating Input	720W
Wheel Diameter	100 mm (4")
No Load Speed (RPM)	11,000
Dimensions (L x W x H)	258x118x101 mm (10-1/8"x4-5/8"x4")
Net Weight	1.6 kg (3.5 lbs.)
Power Supply Cord	2.0 m (6.6 ft.)



Lock nut wrench

**M0910B 100mm (4") Angle Grinder**

Design for light duty applications

459



Continuous Rating Input	540W
Wheel Diameter	100 mm (4")
No Load Speed (RPM)	12,000
Dimensions (L x W x H)	251x118x93 mm (9-7/8"x4-5/8"x3-5/8")
Net Weight	1.6 kg (3.4 lbs)
Power Supply Cord	2.0 m (6.6 ft)

Tool does not come with depressed center wheel



Lock nut wrench

## M9513B 100mm (4") Angle Grinder

High performance and durability at less expense

325



Continuous Rating Input	850W
Wheel Diameter	100 mm (4")
No Load Speed (RPM)	11,000
Dimensions (L x W x H)	273x118x101 mm (10-3/4"x4-5/8"x4")
Net Weight	1.8 kg (4.0 lbs.)
Power Supply Cord	2.0 m (6.6 ft.)



3

Lock nut wrench

## M9510B 115mm (4-1/2") Angle Grinder

High performance and durability at less expense

325



Continuous Rating Input	850W
Wheel Diameter	115 mm (4-1/2")
No Load Speed (RPM)	11,000
Sound Pressure Level	88 dB(A)
Sound Power Level	99 dB(A)
Dimensions (L x W x H)	276x130x111 mm (10-7/8"x5-1/8"x4-3/8")
Net Weight	2.0 kg (4.5 lbs)
Power Supply Cord	2.0 m (6.6 ft.)



3

Lock nut wrench

## M9508B 125mm (5") Angle Grinder

Machined bevel gears provide longer service life

459



Continuous Rating Input	720W
Wheel Diameter	125 mm (5")
No Load Speed (RPM)	11,000
Sound Pressure Level	88 dB(A)
Sound Power Level	99 dB(A)
Dimensions (L x W x H)	261x140x111 mm (10-1/4"x5-1/2"x4-3/8")
Net Weight	1.9 kg (4.1 lbs)
Power Supply Cord	2.0 m (6.6 ft.)



3

Side Grip, Lock Nut Wrench

## M0920B 180mm (7") Angle Grinder

Heavy-duty motor

203



Continuous Rating Input	2,200W
Wheel Diameter	180 mm (7")
No Load Speed (RPM)	8,500
Sound Pressure Level	91 dB(A)
Sound Power Level	102 dB(A)
Dimension (L x W x H)	439x200x141 mm (17-1/4"x9-7/8"x5-9/16")
Net Weight	5.0 kg (11.0 lbs)
Power Supply Cord	2.0 m (6.6 ft)

Tool does not come with depressed center wheel



2

Lock nut wrench, Side grip

## M0921B 230mm (9") Angle Grinder

Heavy-duty motor

203



Continuous Rating Input	2,200W
Wheel Diameter	230 mm (9")
No Load Speed (RPM)	6,600
Sound Pressure Level	91 dB(A)
Sound Power Level	102 dB(A)
Dimension (L x W x H)	439x250x141 mm (17-1/4"x9-7/8"x5-9/16")
Net Weight	5.3 kg (11.6 lbs)
Power Supply Cord	2.0 m (6.6 ft.)

Tool does not come with depressed center wheel



2

Lock nut wrench, Side grip

## M9002B 125mm (5") Angle Grinder

High performance and durability at less expense

303



Continuous Rating Input	1,050W
Wheel Diameter	125 mm (5")
No Load Speed (RPM)	11,000
Sound Pressure Level	91 dB(A)
Sound Power Level	102 dB(A)
Dimension (L x W x H)	361x140x124 mm (14-1/4"x5-1/2"x4-7/8")
Net Weight	2.8 kg (6.1 lbs.)
Power Supply Cord	2.0 m (6.6 ft.)

Tool does not come with depressed center wheel



2

Depressed center wheel, Lock nut wrench, Side grip



## M9100B 6mm (1/4") Die Grinder

Anti-slip ribs on motor housing for higher maneuverability and better control

411



Continuous Rating Input	480W
Capacity	Collet: 6 mm or 1/4"
Max Wheel Diameter	20 mm (13/16")
No Load Speed (RPM)	33,000
Dimensions (L x W x H)	350x75x75 mm (13-3/4"x2-15/16"x2-15/16")
Net Weight	1.4 kg (3.1 lbs)
Power Supply Cord	2.0 m (6.6 ft)

Tool does not come with wheel point



6

Wrenches 2, Tool does not come with wheel point



**M5801B** 185mm (7-1/4") Circular Saw

Well-balanced and Lightweight for superior handling and performance **303**



Continuous Rating Input	1,050W
Blade Diameter	185 mm (7-1/4")
Max Cutting Capacity	90°: 66 mm (2-5/8") 45°: 44 mm (1-3/4")
No Load Speed (RPM)	4,900
Dimensions (L x W x H)	284x231x243 mm (11-1/8"x9-1/8"x9-9/16")
Net Weight	3.5 kg (7.7 lbs)
Power Supply Cord	2.0 m (6.6 ft.)



Guide rule, Hex wrench, TCT saw blade

**M2300B** 255mm (10") Compound Miter Saw

Externally accessible brushes for easy serviceability **JM23000123**



Continuous Rating Input	1,500W
Blade Diameter	255 mm (10")
Miter Angle	45° L / 45° R
Bevel Angle	45° L
Max Cutting Capacity	90° Miter: 75 x 130 mm (2-15/16" x 5-1/8") 45° Miter, L/R: 75 x 90 mm (2-15/16" x 3-9/16")
No Load Speed (RPM)	4,200
Sound Power Level	105 dB(A)
Dimensions (L x W x H)	610x485x15 mm (24"x19-1/8"x20-1/4")
Net Weight	14.7 kg (32.5 lbs)
Power Supply Cord	2.5 m (8.2 ft)



Wrench, Dust Bag (Holders x2), Vise Assembly, Triangular Rule, Set Plate



**M4302B** Jig Saw

450 W Top Handle Variable Speed Jig Saw **411**



Continuous Rating Input	450W
Max Cutting Capacity	Wood: 55 mm (2-3/16") Steel: 6 mm (1/4")
Length of Stroke	26 mm (1")
Strokes Per Minute (SPM)	0 - 3,100
Sound Power Level	99 dB(A)
Dimensions (L x W x H)	219x85x191 mm (8-5/8"x3-3/8"x7-1/2")
Net Weight	2.5 kg (5.5 lbs.)
Power Supply Cord	2.0 m (6.6 ft.)



Jig Saw Blade, Hex Wrench

**M4301B** Jig Saw

Light duty model with continuous input 450W **64**



Continuous Rating Input	450W
Max Cutting Capacity	Wood: 65 mm (2-9/16") at 90° Steel: 6 mm (1/4")
Length of Stroke	18 mm (11/16")
Strokes Per Minute (SPM)	0 - 3,100
Sound Pressure Level	82 dB(A)
Sound Power Level	93 dB(A)
Dimensions (L x W x H)	214x75x202 mm (8-3/8"x2-15/16"x8")
Net Weight	1.9 kg (4.1 lbs)
Power Supply Cord	2.0 m (6.6 ft)



Jig Saw Blade Set, Hex Wrench

**M4500B** Recipro Saw

Screw-down blade clamp **303**



Screw-down blade clamp

Continuous Rating Input	1,010W
Length of Stroke	28 mm (1-1/8")
Strokes Per Minute (SPM)	0 - 2,800
Capacity	Pipe: 130 mm (5-1/8") Wood: 255 mm (10")
Sound Power Level	99 dB(A)
Dimensions (L x W x H)	457x98x174 mm (18"x3-7/8"x6-7/8")
Net Weight	3.1 kg (6.9 lbs)
Power Supply Cord	2.0 m (6.6 ft)



Hex wrench

**M3700B** 6mm (1/4") Trimmer

Ergonomic slim body design for added comfort and control **411**



Continuous Rating Input	530W
Collet Capacity	6 mm or 1/4"
No Load Speed (RPM)	35,000
Plunge Capacity	0 - 42 mm (0 - 1-5/8")
Sound Power Level	94 dB(A)
Dimension (L x W x H)	82x90x199 mm (3-1/4"x3-1/2"x7-7/8")
Net Weight	1.4 kg (3.1 lbs.)
Power Supply Cord	2.0 m (6.6 ft.)



Trimmer Guide Assembly, Straight Guide Assembly, Template Guide, Straight Bit (Carbidge-Tipped), Wrenches 2

**M3601B** 8mm (3/8") Router

High performance and durability at less expense **106**



Continuous Rating Input	900W
Collet Capacity	6 mm, 8 mm or 1/4", 3/8"
Plunge Capacity	0 - 35 mm (0 - 1-3/8")
No Load Speed (RPM)	27,000
Sound Pressure Level	91 dB(A)
Sound Power Level	102 dB(A)
Dimensions (L x W x H)	256x110x218 mm (10-1/8"x4-5/16"x8-5/8")
Net Weight	2.7 kg (6.0 lbs)
Power Supply Cord	2.0 m (6.6 ft)



Straight Guide 1/4", Straight Bit, Wrenches 2

## M3600B 12mm (1/2") Router

High performance and durability at less expense

203



Continuous Rating Input	1,650W
Collet Capacity	12 mm or 1/2"
Plunge Capacity	0 - 60 mm (0 - 2-3/8")
No Load Speed (RPM)	22,000
Sound Power Level	97 dB(A)
Dimensions (L x W x H)	284x148x300 mm (11-1/8"x5-7/8"x11-3/4")
Net Weight	5.5 kg (12.2 lbs.)
Power Supply Cord	2.0 m (6.6 ft.)



Straight Guide, Guide Holder Assembly, Collet Sleeve (6mm or 1/4"), Collet Sleeve (8mm or 3/8"), Straight Bit, Wrench

## M1902B 82mm (3-1/4") Power Planer

82mm power planer with excellent cost performance

411



Continuous Rating Input	500W
Planing Width	82 mm (3-1/4")
Planing Depth	1 mm (1/32")
Max Shiplapping	9 mm (11/32")
No Load Speed (RPM)	16,000
Sound Power Level	95 dB(A)
Dimensions (L x W x H)	285x157x160mm (11-1/4"x6-3/16"x6-5/16")
Net Weight	2.7 kg (5.8 lbs)
Power Supply Cord	2.0 m (6.6 ft)

Shiplapping: 9mm (11/32")



Planer blade 82, Sharpening Holder Assembly (for unit with resharpenable blade only), Blade gauge assembly, Socket wrench 9, Guide Rule, Dressing stone

## M9204B 125mm (5") Random Orbit Sander

Ergonomically designed palm grip for comfortable handling

419



Continuous Rating Input	240W
Pad Size	123 mm (4-7/8")
Abrasive Paper Size	125 mm (5")
Orbits Per Minute (OPM)	12,000
Strokes Per Minute (SPM)	24,000
Orbit Diameter	2.8 mm (1/8")
Sound Pressure Level	81 dB(A)
Sound Power Level	92 dB(A)
Dimensions (L x W x H)	153x123x144 mm (6"x4-7/8"x5-5/8")
Net Weight	1.2 kg (2.6 lbs)
Power Supply Cord	2.0 m (6.6 ft)



Abrasive paper, Dust bag

## M9400B 100mm (4") Belt Sander

High performance and durability at less expense

153



Continuous Rating Input	940W
Belt Size	100 x 610 mm (4" x 24")
Belt Speed	380 m/min (1,250 ft/min)
Sound Pressure Level	87 dB(A)
Sound Power Level	98 dB(A)
Dimensions (L x W x H)	354x175x169 mm (14"x6-7/8"x6-5/8")
Net Weight	6.2 kg (13.7 lbs.)
Power Supply Cord	2.0 m (6.6 ft.)



Abrasive belt, Step, Dust bag assembly, Carbon plate

## M9200B Finishing Sander

Extremely versatile sander

419



Continuous Rating Input	180W
Pad Size	112 x 102 mm (4-3/8" x 4")
Abrasive Paper Size	114 x 140 mm (4-1/2" x 5-1/2")
Orbits Per Minute (OPM)	14,000
Sound Pressure Level	79 dB(A)
Dimensions (L x W x H)	110x112x133 mm (4-5/16"x4-3/8"x5-1/4")
Net Weight	0.9 kg (2 lbs)
Power Supply Cord	2.0 m (6.6 ft)



Abrasive paper x6

## M9203B Finishing Sander

12,000 OPM for increased efficiency and smooth finish sanding

64



Continuous Rating Input	190W
Pad Size	92 x 185 mm (3-5/8" x 7-1/4")
Abrasive Paper Size	93 x 228 mm (3-5/8" x 9")
Orbits Per Minute (OPM)	12,000
Strokes Per Minute (SPM)	24,000
Orbit Diameter	2.0 mm (1/16")
Sound Pressure Level	75 dB(A)
Dimensions (L x W x H)	252x92x154 mm (9-7/8"x3-5/8"x6-1/16")
Net Weight	1.4 kg (3.2 lbs)
Power Supply Cord	2.0 m (6.6 ft)



Abrasive paper #120, Punch Plate, Dust bag

## M4000B Blower

In-line grip for higher maneuverability

85



Continuous Rating Input	530W
Air Volume	1.2-2.9 m <sup>3</sup> /min
No Load Speed (RPM)	8,500 - 16,000
Sound Power Level	101 dB(A)
Dimensions (L x W x H)	427x161x212 mm (16-3/4"x6-3/8"x8-3/8")
Net Weight	1.5 kg (3.4 lbs)
Power Supply Cord	2.0 m (6.6 ft)



Nozzle assembly, Sash nozzle

## M4001B Blower

600 W Variable Speed Blower

303



Continuous Rating Input	600W
Max Air Volume	0 - 4.1 m <sup>3</sup> /min
Max Air Velocity	0 - 91 m/s
Air Pressure	0 - 5.7 kPa
No Load Speed (RPM)	0 - 16,000
Sound Power Level	93 dB(A)
Dimensions (L x W x H)	480x185x178 mm (18-7/8"x7-1/4"x7")
Net Weight	1.9 - 2.0 kg (4.3 - 4.5 lbs)
Power Supply Cord	2.0 m (6.6 ft.)



Nozzle, Dust Bag



## Makita Cordless Part Number Breakdown

<b>DSE</b>	Charger (DC10WA), 2X7.2V - 1.0Ah Batteries (BL7010)	
<b>DW</b>	Charger (DC10WA), 1X10.8V - 1.3Ah Battery (BL1013)	
<b>DWE</b>	Charger (DC10WA), 2X10.8V - 1.3Ah Batteries (BL1013)	
<b>DWYE</b>	Standard Charger (DC10WD), 2X12Vmax - 1.5Ah Batteries (BL1016)	
<b>DSYE</b>	Fast Charger (DC10SB), 2X12Vmax - 1.5Ah Batteries (BL1016)	
<b>DSAE</b>	Fast Charger (DC10SB), 2X12Vmax - 2.0Ah Batteries (BL1021B)	
<b>DSAJ</b>	Fast Charger (DC10SB), 2X12Vmax - 2.0Ah Batteries (BL1021B), Makpac	
<b>DSME</b>	Fast Charger (DC10SB), 2X12Vmax - 4.0Ah Batteries (BL1041B)	
<b>SYE</b>	Standard Charger (DC18SD), 2X18V - 1.5Ah Batteries (BL1815B)	
<b>RYE</b>	Rapid Charger (DC18RC), 2X18V - 1.5Ah Batteries (BL1815B)	
<b>SF</b>	Standard Charger (DC18SD), 1X18V - 3.0Ah Battery (BL1830B)	
<b>RF</b>	Rapid Charger (DC18RC), 1X18V - 3.0Ah Battery (BL1830B)	
<b>RFE/ RF2</b>	Rapid Charger (DC18RC), 2X18V - 3.0Ah Batteries (BL1830B)	
<b>RFJ</b>	Rapid Charger (DC18RC), 2X18V - 3.0Ah Batteries (BL1830B), Makpac	
<b>RME</b>	Rapid Charger (DC18RC), 2X18V - 4.0Ah Batteries (BL1840B)	
<b>RTE/ RT2</b>	Rapid Charger (DC18RC), 2X18V - 5.0Ah Batteries (BL1850B)	
<b>RTJ</b>	Rapid Charger (DC18RC), 2X18V - 5.0Ah Batteries (BL1850B), Makpac	
<b>PT2</b>	Dual Port Rapid Charger (DC18RD), 2X18V - 5.0Ah Batteries (BL1850B)	
<b>PG2J</b>	Dual Port Rapid Charger (DC18RD), 2X18V - 6.0Ah Batteries (BL1860B), Makpac	
<b>G2</b>	2X18V - 6.0Ah Batteries (BL1860B)	

### Makita Coding System - Ending Alphabet

**DDF484 R T E**

**Charger**

**S** - Standard Charger  
**R** - Rapid (Fast) Charger  
**P** - Two Port Charger

**Come with Battery**

**H** - 1.3Ah    **M** - 4.0Ah  
**Y** - 1.5Ah    **T** - 5.0Ah  
**A** - 2.0Ah    **G** - 6.0Ah  
**D** - 2.5Ah    **L** - 8.0Ah  
**F** - 3.0Ah

Comes with  
2 batteries

**Other:**  
**B** - Double Insulation  
**C** - Electronic Control  
**F** - LED Light  
**K** - Carrying Case  
**2** - 18V x 2 Tools

**Z**

Tool come with  
carton box only

For more information, please contact Makita authorised distributor's technical team.

# Combination / Rotary Hammer Drill Capability Chart

		Material for drilling																	Highly reinforced concrete	Concrete, granite, stone, brick	Metal/ wood	Working direction	Drilling/ chiselling ratio		
		EPTA Weight (kg)	0	10	20	30	40	50	60	70	80	90	100	110	120	130	140	150						160	
16mm series	HR166D	1.8~2.4	3.2-16 3.2-10																	Diamond core 32 (dry type)	✓	✓✓✓	✓	↔	■
	SDS-plus		3.2-16 3.2-10																	Diamond core 32 (dry type)	✓	✓✓✓	✓	↔	■
17mm series	DHR171	2.1~2.8	3.2-17 3.2-10																	Diamond core 32 (dry type)	✓	✓✓✓	✓	↔	■
	SDS-plus		3.2-17 3.2-10																	Diamond core 32 (dry type)	✓	✓✓✓	✓	↔	■
18mm series	HR1840/41F	2.0~2.5	3.2-18 3.2-10																	Diamond core 32 ~ 65 (dry type)	✓	✓✓✓	✓	↔	■
	SDS-plus		3.2-18 3.2-10																	Diamond core 32 (dry type)	✓	✓✓✓	✓	↔	■
18mm series	DHR182	2.4~3.2	3.2-18 3.2-10																	Diamond core 32 (dry type)	✓	✓✓✓	✓	↔	■
	SDS-plus		3.2-18 3.2-10																	Diamond core 32 (dry type)	✓	✓✓✓	✓	↔	■
20mm series	DHR202	3.5	3.2-20 4-12																	Diamond core 32 (dry type)	✓	✓✓✓	✓	↔	■
	SDS-plus		3.2-20 4-12 35-54																	Diamond core 32 ~ 65 (dry type)	✓	✓✓✓	✓	↔	■
22mm series	DHR2230	2.6	3.2-22 4-14																	Diamond core 32 ~ 65 (dry type)	✓	✓✓✓	✓	↔	■
	SDS-plus		3.2-22 4-14 35-54																	Diamond core 32 ~ 65 (dry type)	✓	✓✓✓	✓	↔	■
22mm series	MT870	2.5	3.2-22 4-14																	Diamond core 32 ~ 65 (dry type)	✓	✓✓✓	✓	↔	■
	SDS-plus		3.2-22 4-14 35-54																	Diamond core 32 ~ 65 (dry type)	✓	✓✓✓	✓	↔	■
23mm series	HR2300	2.7	3.2-23 4-15																	Diamond core 32 ~ 70 (dry type)	✓	✓✓✓	✓	↔	■
	SDS-plus		3.2-23 4-15 35-68																	Diamond core 32 ~ 70 (dry type)	✓	✓✓✓	✓	↔	■
23mm series	HR2310T	2.9	3.2-23 4-15																	Diamond core 32 ~ 70 (dry type)	✓	✓✓✓	✓	↔	■
	SDS-plus		3.2-23 4-15 35-68																	Diamond core 32 ~ 70 (dry type)	✓	✓✓✓	✓	↔	■
23mm series	HR2320T	2.9	3.2-23 4-15																	Diamond core 32 ~ 70 (dry type)	✓	✓✓✓	✓	↔	■
	SDS-plus		3.2-23 4-15 35-68																	Diamond core 32 ~ 70 (dry type)	✓	✓✓✓	✓	↔	■
24mm series	HR2460	2.8	3.2-24 4-16																	Diamond core 32 ~ 65 (dry type)	✓	✓✓✓	✓	↔	■
	SDS-plus		3.2-24 4-16 35-54																	Diamond core 32 ~ 65 (dry type)	✓	✓✓✓	✓	↔	■
24mm series	HR2470	2.9	3.2-24 4-16																	Diamond core 32 ~ 65 (dry type)	✓	✓✓✓	✓	↔	■
	SDS-plus		3.2-24 4-16 35-54																	Diamond core 32 ~ 65 (dry type)	✓	✓✓✓	✓	↔	■
24mm series	DHR241	3.5	3.2-20 4-12																	Diamond core 32 (dry type)	✓	✓✓✓	✓	↔	■
	SDS-plus		3.2-20 4-12 35-54																	Diamond core 32 (dry type)	✓	✓✓✓	✓	↔	■
24mm series	DHR242	3.1~3.8	3.2-24 4-16																	Diamond core 32 ~ 65 (dry type)	✓	✓✓✓	✓	↔	■
	SDS-plus		3.2-24 4-16 35-54																	Diamond core 32 ~ 65 (dry type)	✓	✓✓✓	✓	↔	■
26mm series	DHR263	3.5	3.2-26 4-18																	Diamond core 32 ~ 65 (dry type)	✓	✓✓✓	✓	↔	■
	SDS-plus		3.2-26 4-18 35-54																	Diamond core 32 ~ 65 (dry type)	✓	✓✓✓	✓	↔	■
26mm series	HR2600 Series	2.8~2.9	3.2-26 4-18																	Diamond core 32 ~ 80 (dry type)	✓	✓✓✓	✓	↔	■
	SDS-plus		3.2-26 4-18 35-68																	Diamond core 32 ~ 80 (dry type)	✓	✓✓✓	✓	↔	■
26mm series	HR2630 Series	2.8~3.1	3.2-26 4-18																	Diamond core 32 ~ 80 (dry type)	✓	✓✓✓	✓	↔	■
	SDS-plus		3.2-26 4-18 35-68																	Diamond core 32 ~ 80 (dry type)	✓	✓✓✓	✓	↔	■
26mm series	HR2650 Series	3.0~3.2	3.2-26 4-18																	Diamond core 32 ~ 80 (dry type)	✓	✓✓✓	✓	↔	■
	SDS-plus		3.2-26 4-18 35-68																	Diamond core 32 ~ 80 (dry type)	✓	✓✓✓	✓	↔	■
26mm series	HR2661	3.2	3.2-26 4-18																	Diamond core 32 ~ 80 (dry type)	✓	✓✓✓	✓	↔	■
	SDS-plus		3.2-26 4-18 35-68																	Diamond core 32 ~ 80 (dry type)	✓	✓✓✓	✓	↔	■
26mm series	M8701	2.7	3.2-26 4-18																	Diamond core 32 ~ 80 (dry type)	✓	✓✓✓	✓	↔	■
	SDS-plus		3.2-26 4-18 35-68																	Diamond core 32 ~ 80 (dry type)	✓	✓✓✓	✓	↔	■
28mm series	HR2800 Series	3.4~3.6	3.2-28 6-20																	Diamond core 32 ~ 80 (dry type)	✓	✓✓✓	✓	↔	■
	SDS-plus		3.2-28 6-20 35-80																	Diamond core 32 ~ 80 (dry type)	✓	✓✓✓	✓	↔	■
28mm series	DHR282 Series	3.9~5.0	3.2-28 6-20																	Diamond core 32 ~ 65 (dry type)	✓	✓✓✓	✓	↔	■
	SDS-plus		3.2-28 6-20 35-54																	Diamond core 32 ~ 65 (dry type)	✓	✓✓✓	✓	↔	■
28mm series	HR001G Series	3.9~4.6	3.2-28 6-20																	Diamond core 32 ~ 65 (dry type)	✓	✓✓✓	✓	↔	■
	SDS-plus		3.2-28 6-20 35-54																	Diamond core 32 ~ 65 (dry type)	✓	✓✓✓	✓	↔	■
30mm series	HR3210FCT Series	4.8~5.4	4-32 10-22																	Diamond core 32 ~ 90 (dry type)	✓✓✓	✓✓✓	✓	↔	■
40mm series	HR4002	6.6	10-40 16-32																	✓✓✓	✓✓✓		↔	■	
	SDS-max		10-40 16-32 20-105																	✓✓✓	✓✓✓		↔	■	
40mm series	HR4013C Series	6.2~6.8	10-40 16-35																	✓✓✓	✓✓✓		↔	■	
	SDS-max		10-40 16-35 20-105																	✓✓✓	✓✓✓		↔	■	
40mm series	DHR400	7.3~8.1	10-40 16-35																	✓✓✓	✓✓✓		↔	■	
	SDS-max		10-40 16-35 20-105																	✓✓✓	✓✓✓		↔	■	
40mm series	HR005G	7.4~7.9	10-40 16-35																	✓✓✓	✓✓✓		↔	■	
	SDS-max		10-40 16-35 20-105																	✓✓✓	✓✓✓		↔	■	
45mm series	HR4511C Series	8.2~9.0	10-45 22-40																	✓✓✓	✓✓✓		↔	■	
	SDS-max		10-45 22-40 20-125																	✓✓✓	✓✓✓		↔	■	
50mm series	HR5212C Series	10.9~11.9	19-52 25-45																	✓✓✓	✓✓✓		↔	■	
	SDS-max		19-52 25-45 20-160																	✓✓✓	✓✓✓		↔	■	
50mm series	HR006G Series	12.9~14.3	19-52 25-45																	✓✓✓	✓✓✓		↔	■	
	SDS-max		19-52 25-45 20-160																	✓✓✓	✓✓✓		↔	■	

approx: 50% drilling, 50% chiselling

- Tungsten Carbide-tipped usable range
- Recommended range
- Core bits

- ✓✓✓ Optimal
- ✓ Possible



## Carbon Brush List

Carbon Brush	Part Number	Model								
CB-1	181019-9	903								
CB-51	181021-2	1902	3700B	4300BV	6013BR	6016	6300NB			
CB-55	181026-2									
CB-55A	B-80248	8416	JR3000V							
CB-64	191627-8	6412	6413	6510LVR	9035	906	BO3710	BO4540	DP4700	GD0603
CB-64A	B-80254	GV6010	JV0600K							
CB-65	191628-6									
CB-65A	A-81309	6905B	906H	JS1600	JS1670					
CB-70	191914-5	6501								
CB-70A	A-81212									
CB-85	191998-3									
CB-85A	B-80282	HP1630								
CB-100	181030-1	1100	6906	9045B	9215SB	9218SB	9924DB	JN3200	JS3200	PC1100
CB-100A	B-80298									
CB-106	181410-1									
CB-106A	A-81290	1911B	3620	RP0900	UT1301					
CB-132	191972-1	UC3520A	UC4020A	UC3541A	UC4041A					
CB-153	181044-0	1804N	1805N	2012NB	2416S	3501N	3600H	3601B	3612BR	4107R
CB-153A	B-80329	5008B	5008MG	5016B	5103N	5201N	5401N	5402	6910	9105
		9401	HS0600	LF1000	LS1013	LS1016	LS1019L	LS1040	LS1212	LS1214
		LS1216	LS1219L	LS1440	N5900B	TW1000	UC3530A	UC3531A	UC4030A	UC4051A
CB-173	195483-8	VC2510L	VC3210L							
CB-203	191953-5	2414NB	3612C	HW1200	HW1300	LC1230	LW1400	LW1400	RP1801	
CB-203A	B-80341									
CB-253	194547-5	PC5000C								
CB-303	191963-2	2107F	4100NH	4100NH3Z	4131	5606B	5740NB	5806B	9015B	9016B
CB-303A	B-80379	9227C	9237C	CA5000	DA4000LR	GA5010	GA5020	GA6010	HS7010	HS7600
		JN3201J	JR3050T	JR3060T	JR3070CT	JS3201J	LS0714	PV7000C	UB1100	UB1101
		UB1102	UB1103	UT1305	UT2204					
CB-325	194074-2	9553NB	9556NBG	9556PBG	9556HBG	9556HP	9557NBG	9563H	GA4040	GD0600
		GD0601	GD0602	HR2230	HR2300	HR2310T	HR2320T	HR2460	HR2470	HR2600
		HR2601	HR2610	HR2611FT	HR2630	HR2631FT	HR2800	HR2810		
CB-411	191940-4	3709	3901	4403	6922NB	9031	9500NB	9523NB	DS4011	JN1601
CB-411A	B-80391	KP0800	RT0700C	TD0101F	TW0200	TW0350				
CB-415	191950-1	6904VH								
CB-415A	B-80400									
CB-419	191962-4	4304	4350CT	9035H	BO4510H	BO4556	BO5031	DA3010F	FS2300	FS2500
CB-419A	B-80422	FS2700	FS4300	HP1620	HP2030	HP2050	HP2070	HR1830	HR2020	HR2440
		JS1300	TD0100	UH4570X	UH5570X	UH6570X	UH7580X			
CB-459	194722-3	GA4030	GA4031	GA4034	GA54530	GA4534	GA5030	GA5034	HR1840	HR1841
		JS1000	JS1601	JS1602	PJ7000	TM3000C	TM3010C			
	3641000	HW111								
	3641160	HW102								
	375009-001	SJ401								
	EIB106C	HB500								
	JM23000123	LH1201FL	LS1018L	MLT100						

### Auto Cut - Out Carbon Brush

CB-105	181038-5	HM0810A	HM0810TA	HR2010	HR3520					
CB-105A	B-80307									
CB-155	181048-2	HM1201								
CB-155A	B-80335									
CB-204	191957-7	4112HS	4114S	9617	GA7010C	GA7012C	GA7020	GA7030	GA7040R	GA7040S
CB204A	B-80357	GA9010C	GA9012C	GA9030	GA9030R	GA9040S	GA9050	G55000	HM1302	HM1305
		HM1306	HM1810	SA7000C						
CB-218	197129-2	GA7060	GA7060R	GA7061R	GA7062	GA7063R	GA9060	HM1812		
CB-318	191978-9	9563C	GA4040C	GA4041C	GD0800C	PK5001C	PO6000C	PW5001C	SG1250	SG1251J
CB-327	194285-9	HR3000C								
CB-350	194160-9	HK1820	HM0870C	HM0871C	HR3200C	HR4001C	HR4002	HR4003C	HR4003C	HR4030C

### Carbon Brush for Cordless Tools

CB-430	191971-3	8414D	DCS550	DCO180	BGA450	DGA402	DGA452	DGD800	BHR240	DJN161
CB-438		DJS101	DJS161	DJV180	DPB180	DPJ180	DSS501	BUB360	DUC122	DHR165
		DUB361								
CB-434	193466-2	6932FD	6935FD	BTW121						
CB-440	194427-5	DDA351	DDF442	DDF444	BDF450	BDF452	DDF456	DDF458	DDF482	DFR550
		DFS450	DFS451	BHP442	DHP444	DHP444	BHP450	BHP452	BHP454	DHP456
		DHP458	DHP482	DJS130	BTD142	DTD146	DTP140	DTW152	DTW251	DBN500
		TD091D								
CB-441	194435-6	DHR202	DHR241	DHS630	DJR181	DJR182	DJR186	DKP180	DLS713	DSS610
		DTW450								
CB-442	194928-3	BHR261	BHR262	BUC250	BUH550	BUH650	DHR263	DHS710	DUC252	DUC302
		DUH651								
CB-448	196854-2	DTW152	DTW251							

## How to Maximise Battery Performance

### Rechargeable Tool Battery Don'ts

- **Do not Use the Battery till it is flat :** Using the battery till it is flat, can permanently damage the poles and shorten battery life. Recharge the battery as soon as your tool starts to slow down. Unless you are using a NiCd battery operated tool.
- **Do not Overload the Battery :** Use the cordless tool within specification. Do not overload the cordless tool.
- **Do not Get Battery Wet:** Avoid exposing your batteries to water. Immediately wipe away any moisture on the tool or battery.
- **Do not throw or drop the Battery:** Dropping or throwing the battery may cause damage to battery.

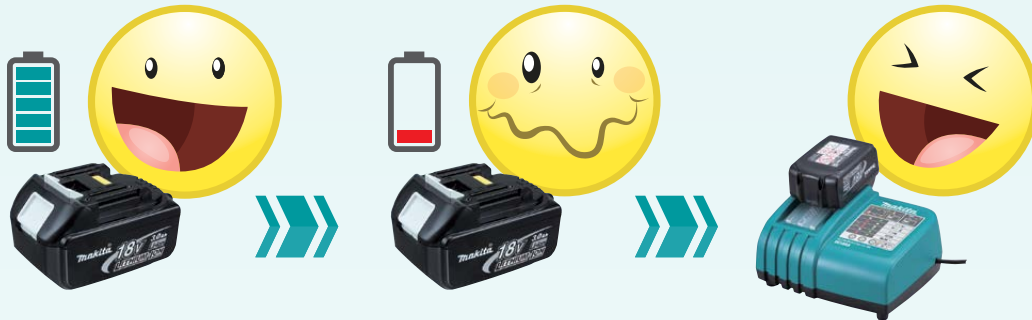

You should stop your operations and charge it when you feel the power is getting lower and lower. This will help to reduce the load to battery and to extend battery lifetime. Never use till empty!!!





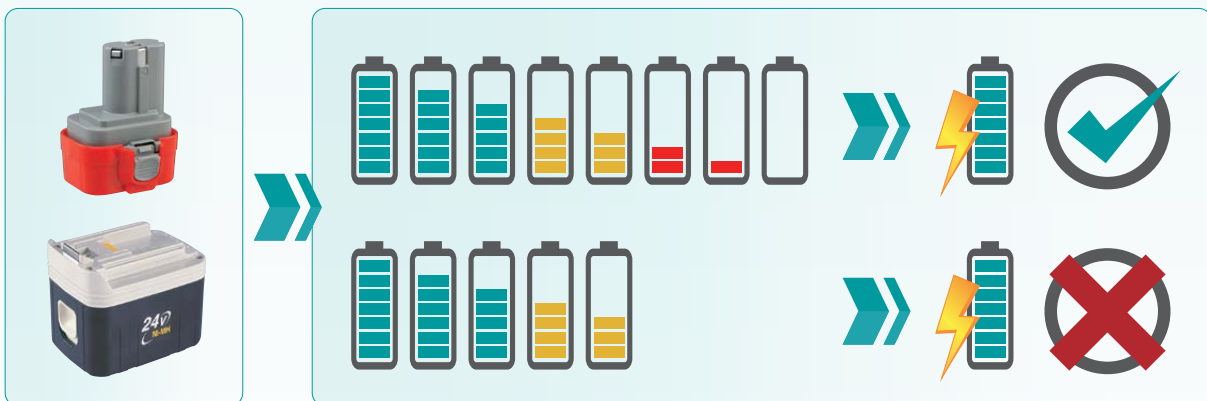



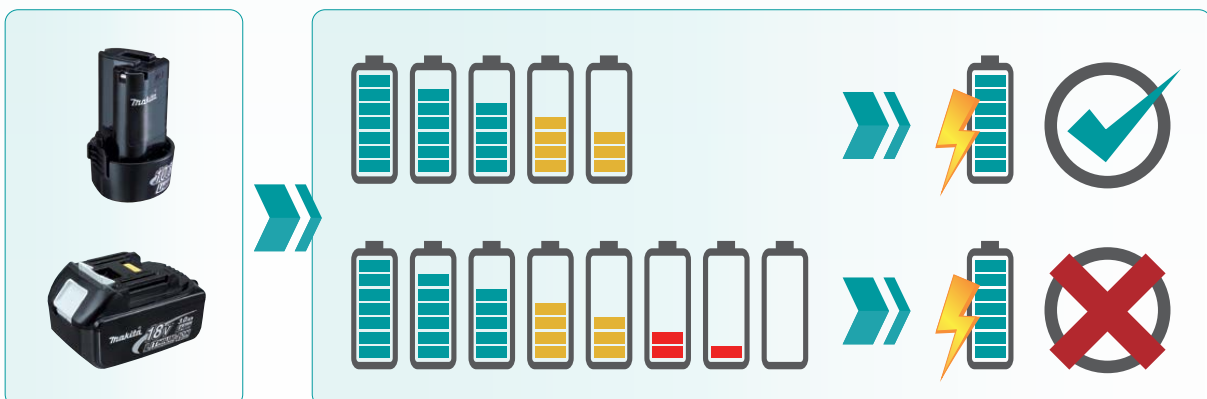

























### When to CHARGE a Ni-Cd / Ni-MH Battery



### When to CHARGE a Li-ion Battery



# Icon

 Double Insulation	 Torque Setting 16	 Bayonet Shank Jig Saw Blade	 Static Free Hose
 Variable Speed	 Torque Setting 18	 Laser Marker	 SDS-PLUS Shank
 Brake	 Torque Setting 20	 Orbital Cutting	 SDS-MAX Shank
 Reversing	 Torque Setting 21	 Hook & Loop	 17mm Hex Shank
 Mechanical 2-Speed	 Torque Setting 21_41	 Depth Adjustment	 21mm Hex Shank
 Mechanical 3-Speed	 Dust Collection	 Sequential and Bump-fire	 28.6mm Hex Shank
 Electronic 2-Speed	 Torque Limiter	 Auto Firing Stop	 30mm Hex Shank
 Electronic 3-Speed	 Constant Speed	 Automatic Oiling	 Built-in Job Light
 Electronic 4-Speed	 Soft Start	 Stainless Tank	 Anti-restart function
 Keyless Chuck	 Bevel Cutting 45 left	 Grass Tangle Removing Function	 Toolless blade change
 Clutch-equipped	 Bevel Cutting L45 R5	 Chain Brake	
 Torque Setting 6	 Bevel Cutting 45 LR	 Anti Vibration	
 Torque Setting 9	 Makita Shank Jig Saw Blade	 Revolving Hose	



[www.makita.com.sg](http://www.makita.com.sg)

## TRADEMARKS



Makita Corporation and its affiliates (collectively referred to as "Makita") are the registered owners of the above trademarks and own the exclusive rights to these trademarks. A party who manufactures, advertises, offers for sale, sells, distributes, imports or exports power tools, batteries and/or related accessories using a trademark which is identical or similar to our trademarks may have infringed our trademarks. Makita take a serious view of trademark infringement and will not hesitate to take any legal action against any party who infringes our trademark rights.

### Makita Singapore Pte Ltd

7, Changi South Street 3, Singapore 486348  
 Phone : +65-6546-8700 Fax : +65-6546-8711  
 Email : [msgproductteam@makita.com.sg](mailto:msgproductteam@makita.com.sg)  
 Website : [www.makita.com.sg](http://www.makita.com.sg)  
 Facebook : [www.facebook.com/MakitaSG](http://www.facebook.com/MakitaSG)



Visit our website



PRINTED IN SINGAPORE